

Wiring Diagrams

Fuse Panels

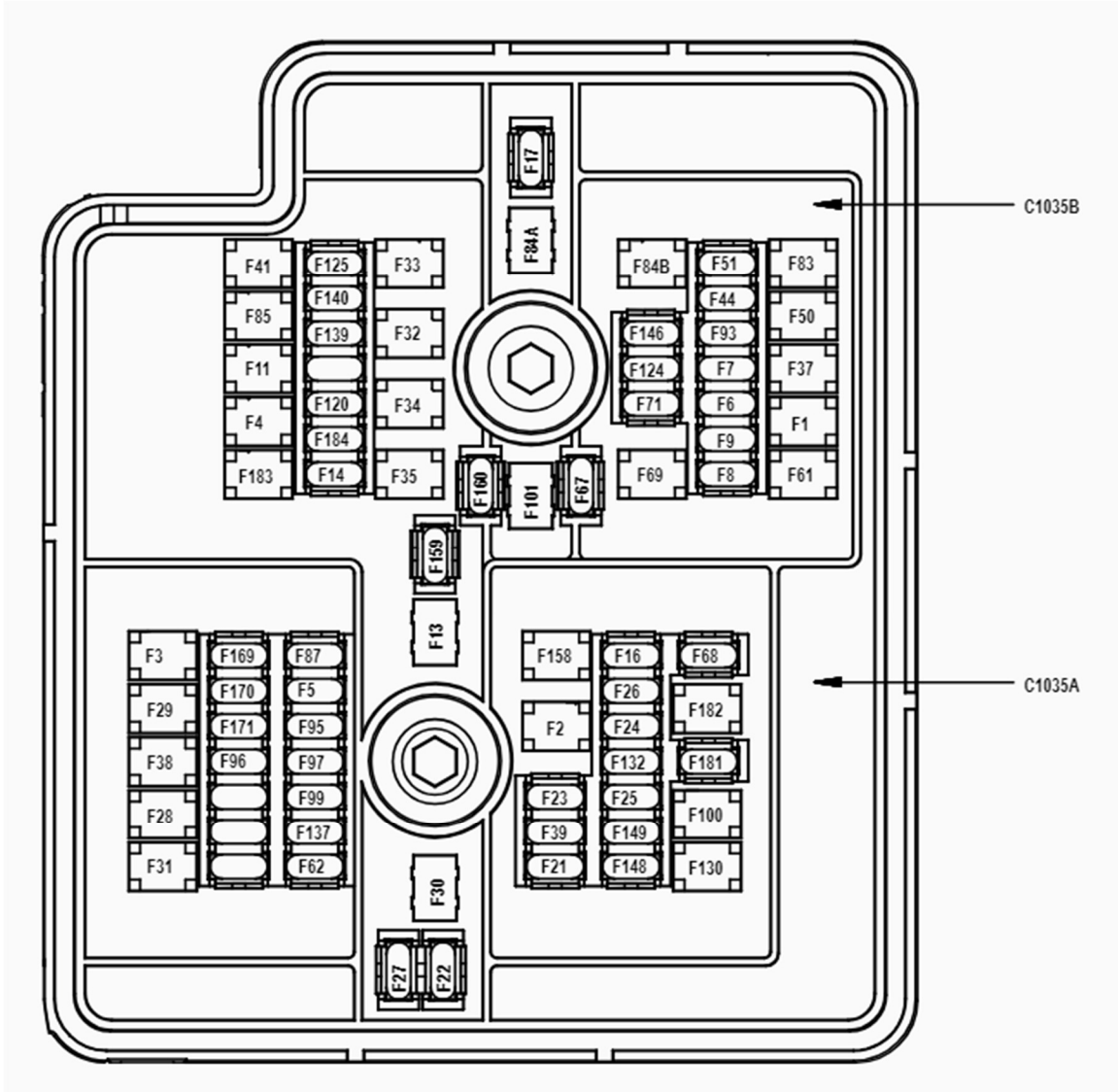

Battery Junction Box (BJB)

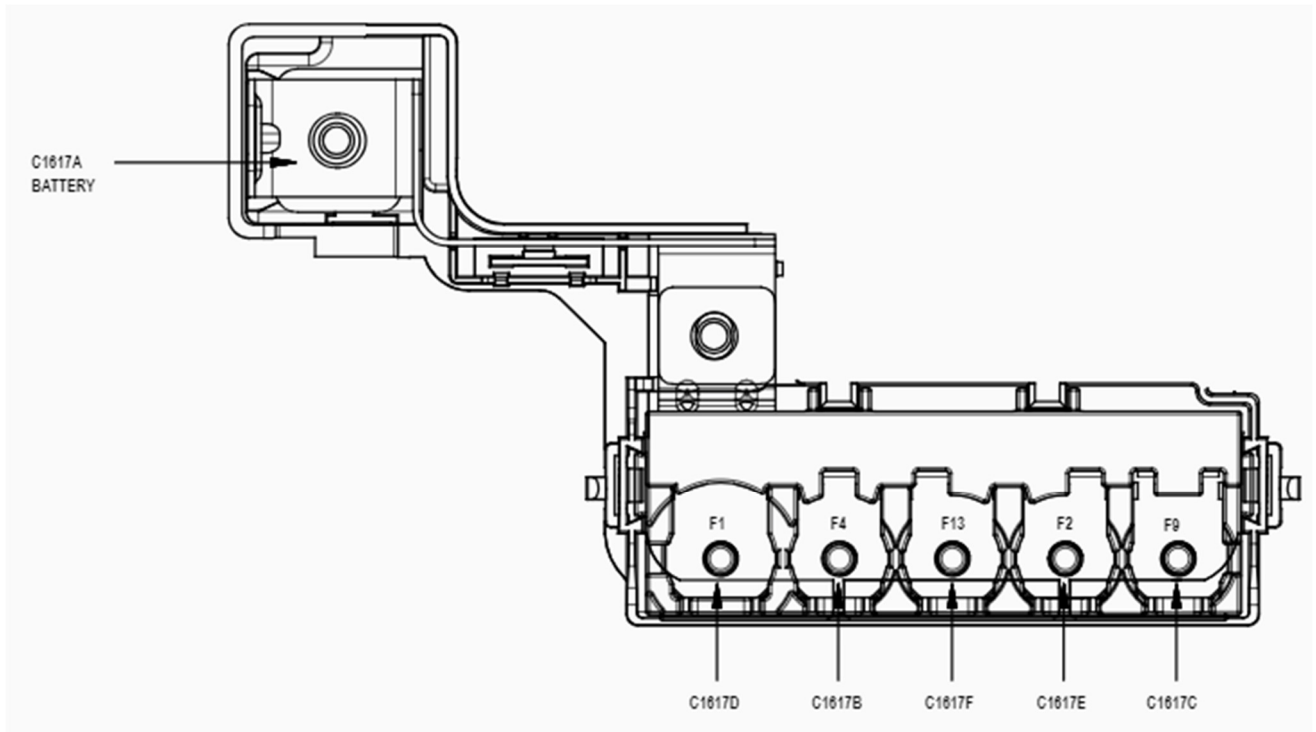

High Current Battery Junction Box (BJB)

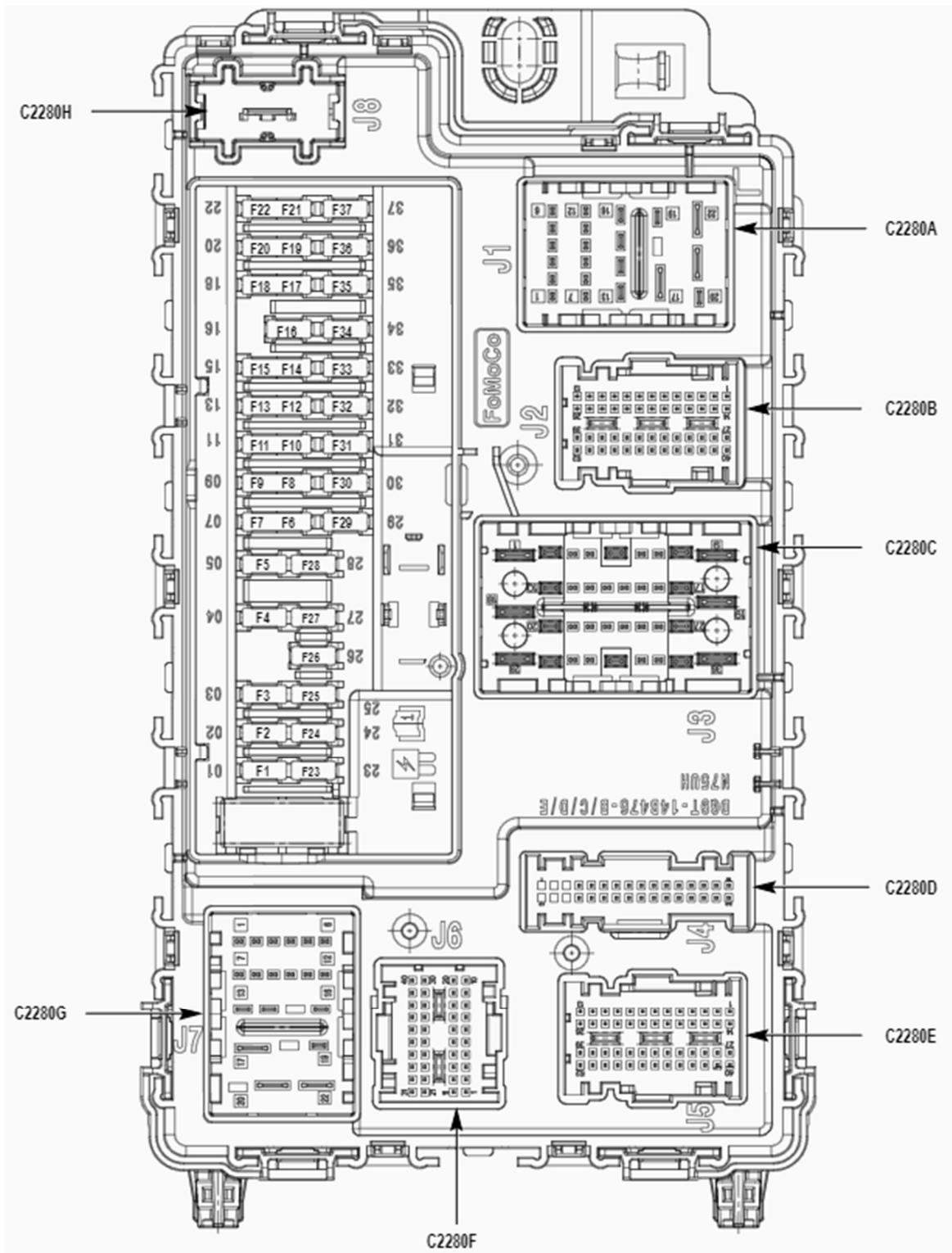

Body Control Module (BCM)

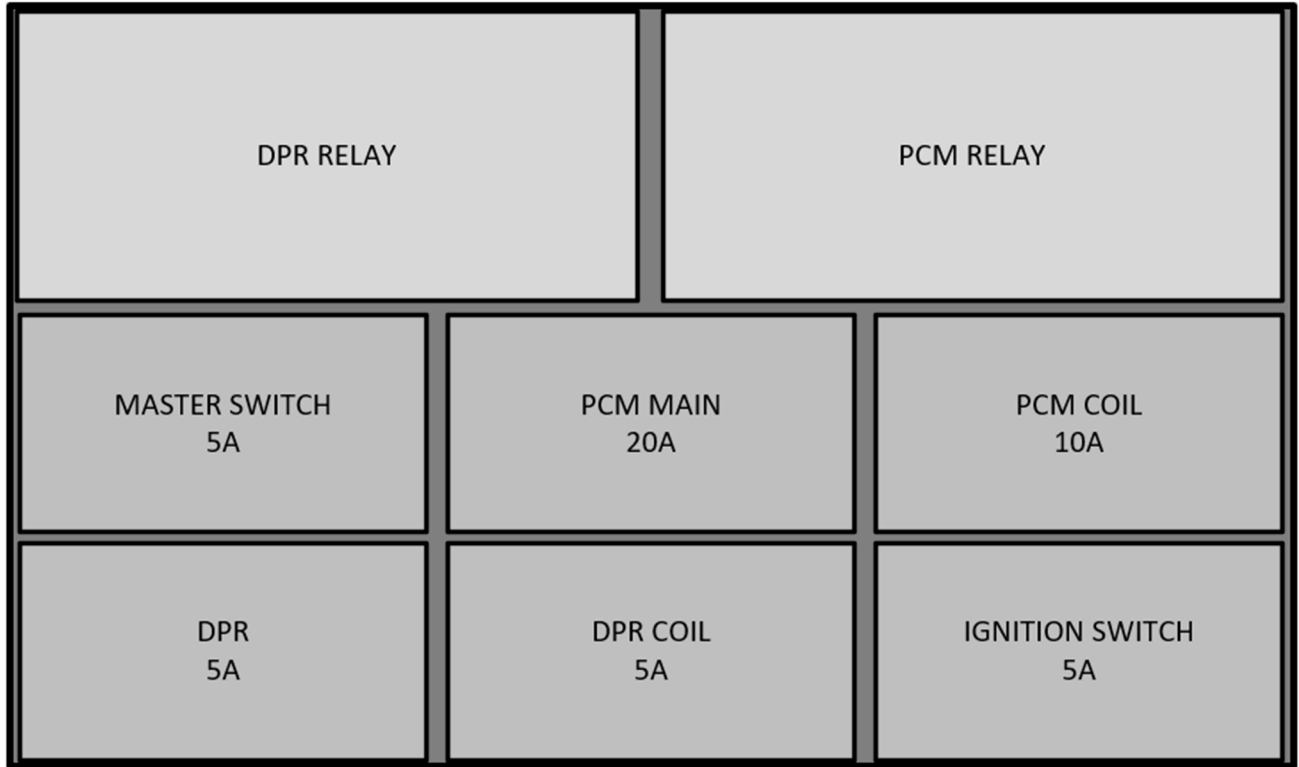

PCM/Diff Pump Fuse Box

1. Factory Connectors

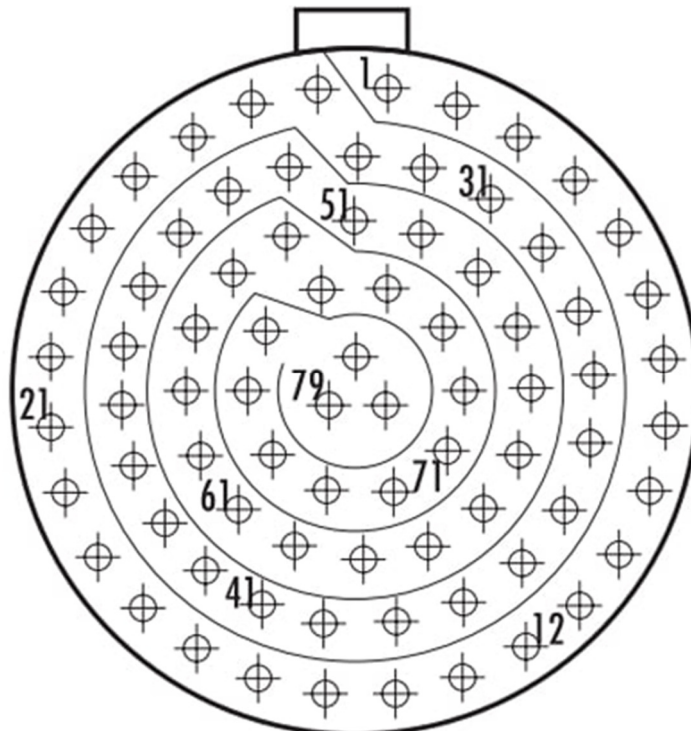

C1 (C187)

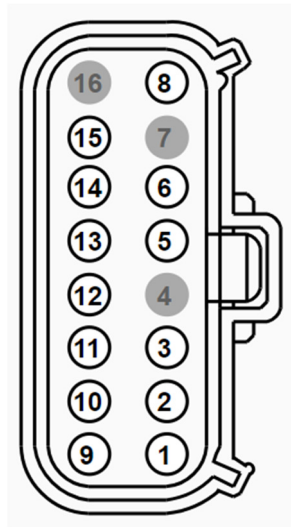

C1021, C1041

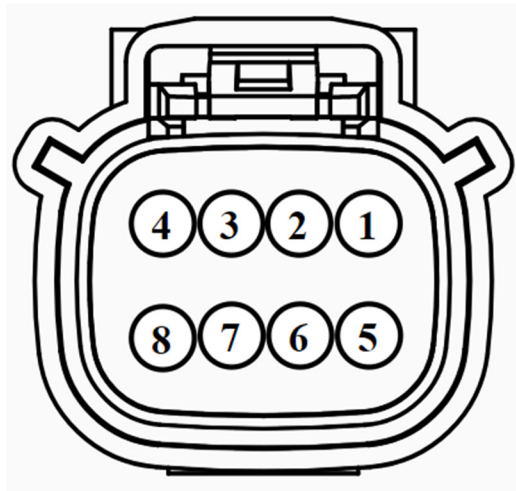

C1023, C1043

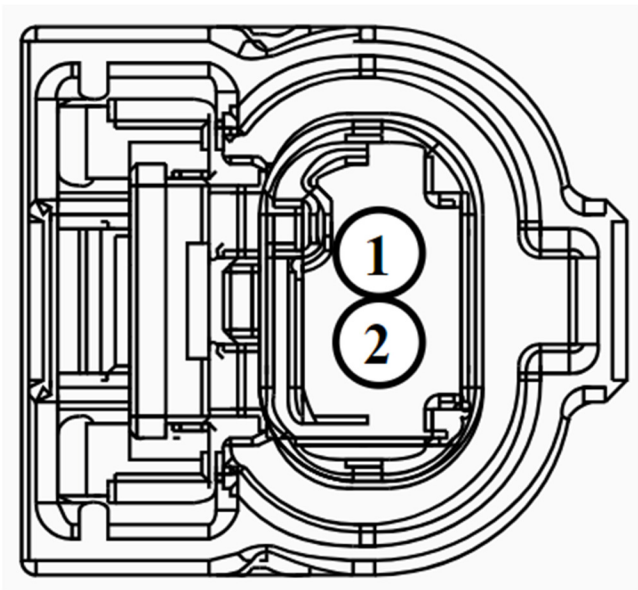

C1029, C1745

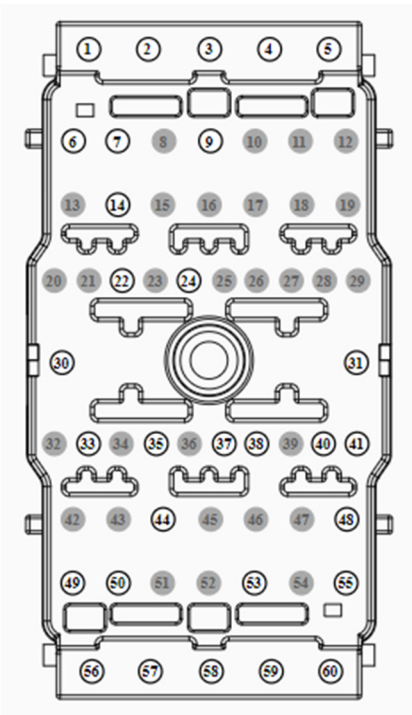

C1035A

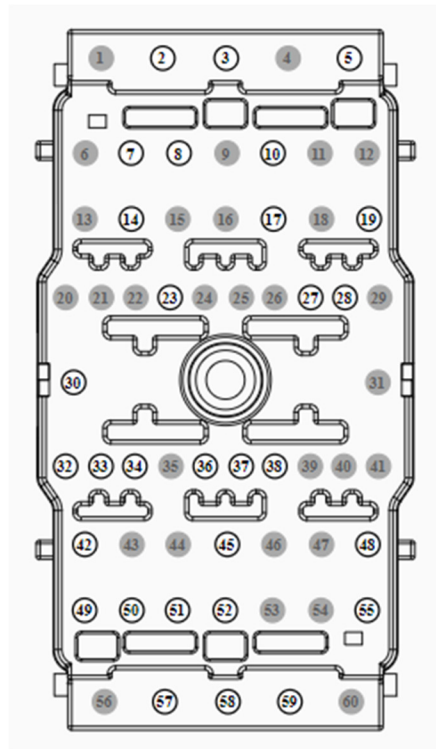

C1035B

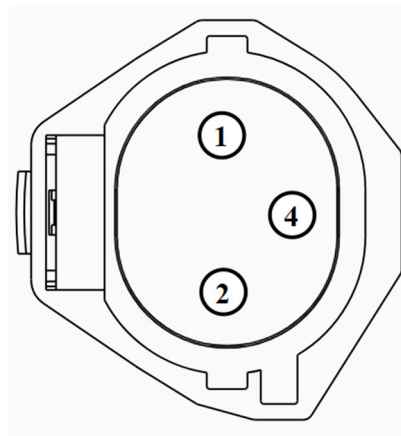

C1076

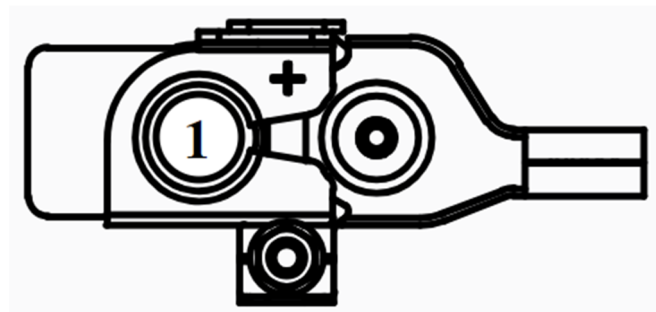

C1100A

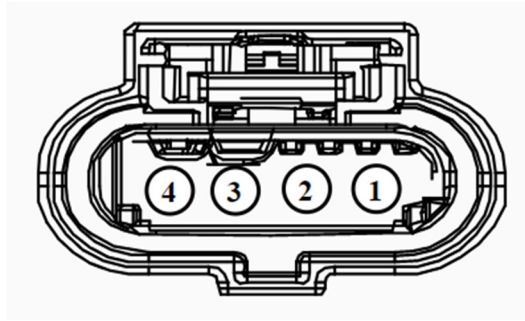

C1257

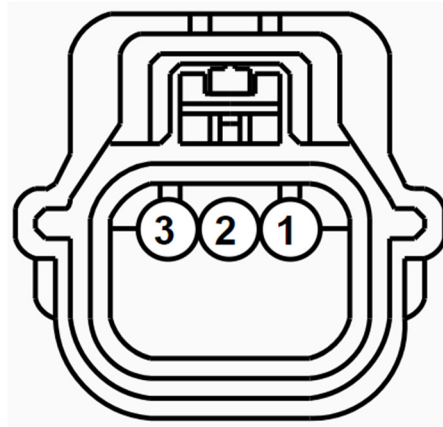

C1260

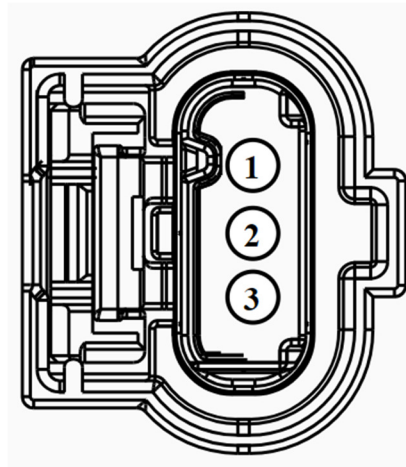

C1275, C1289, C1290, C1339, C1421, C1422, C1613, C1626, C2520

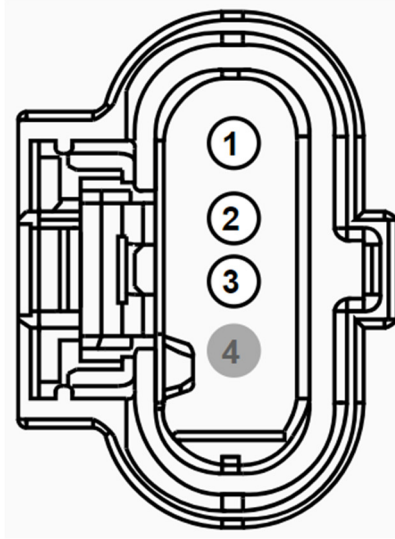

C128, C1454, C1911

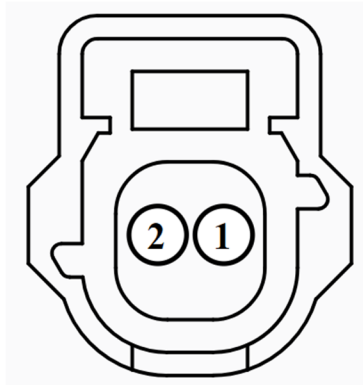

C132

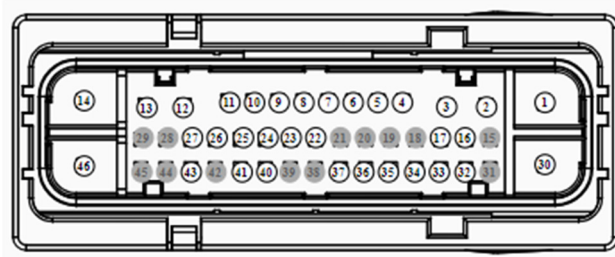

C135

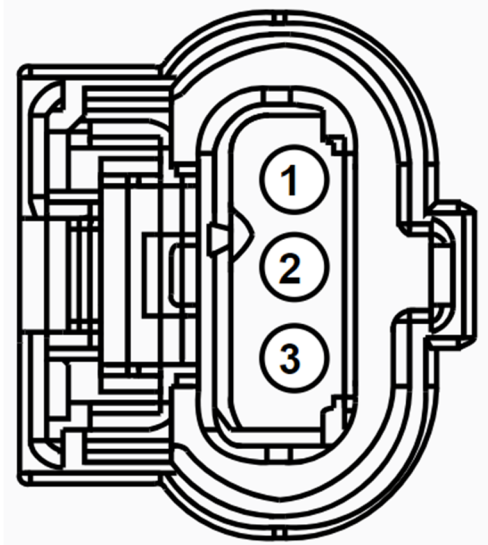

C1360

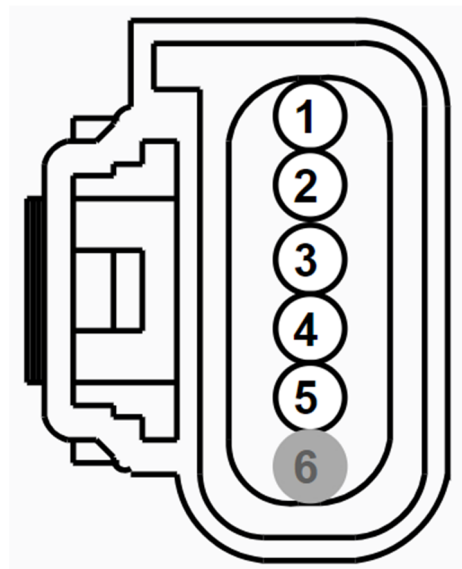

C1368, C1449, C1854

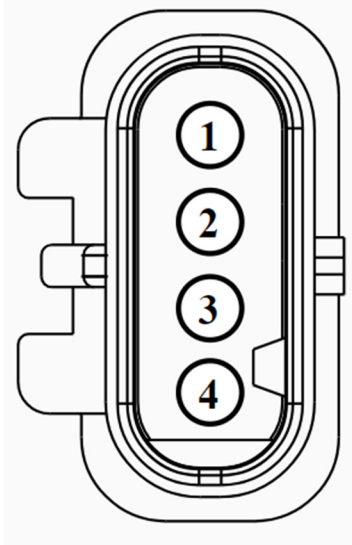

C141, C142

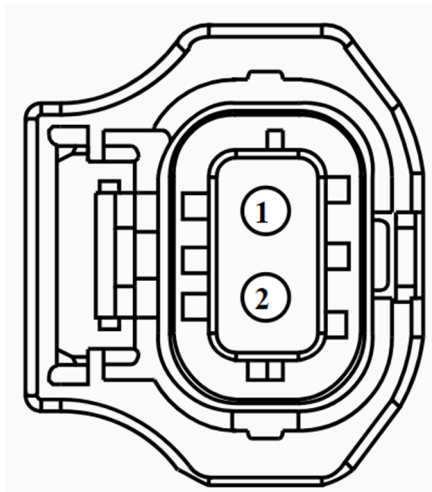

C1451, C1548, C1610, C1739

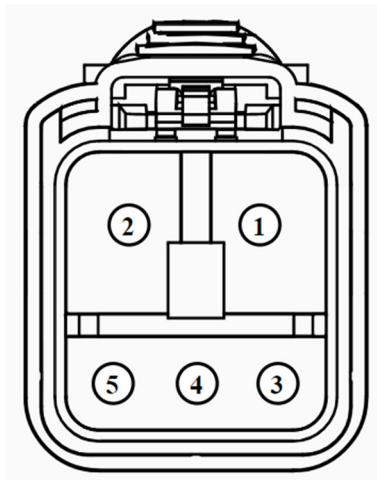

C1467A

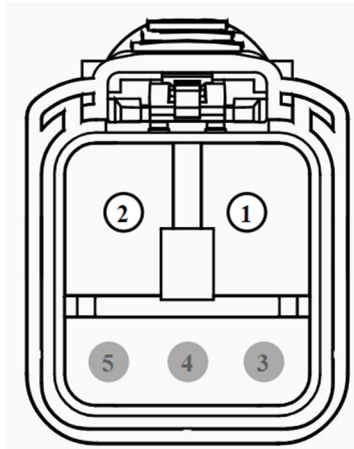

C1467B

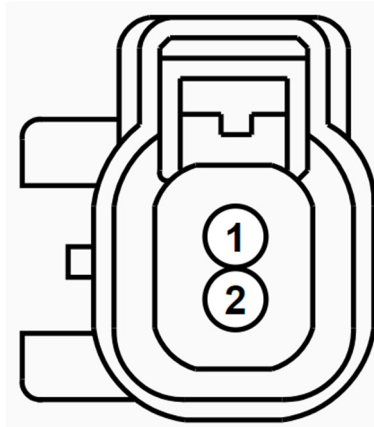

C150, C160, C426, C440

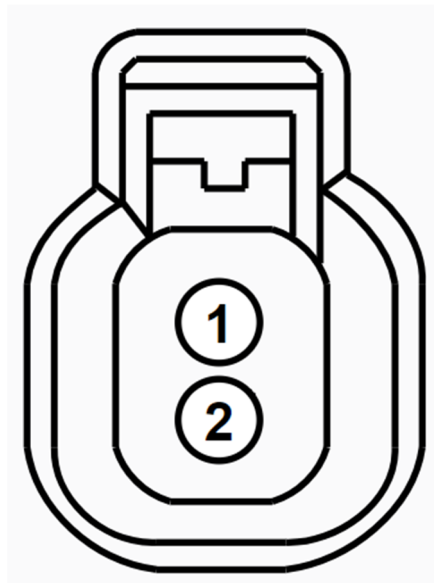

C1561, C1562, C1563, C1564, C1565, C1566, C1567, C1568, C4884

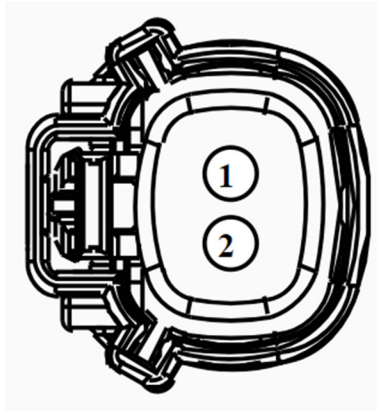

C1589

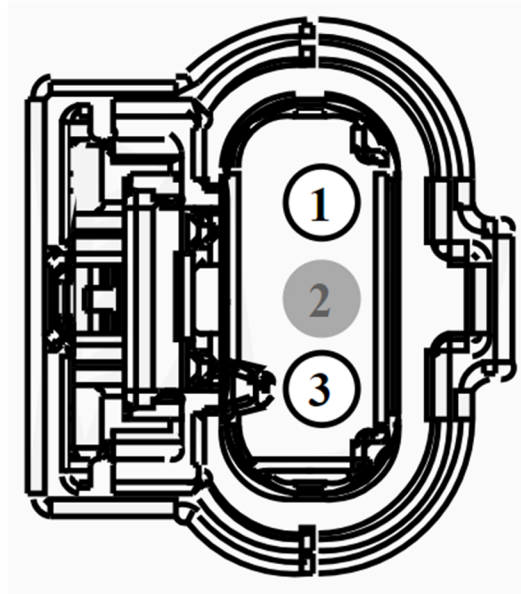

C1601, C1602, C1603, C1604, C1605, C1606, C1607, C1608

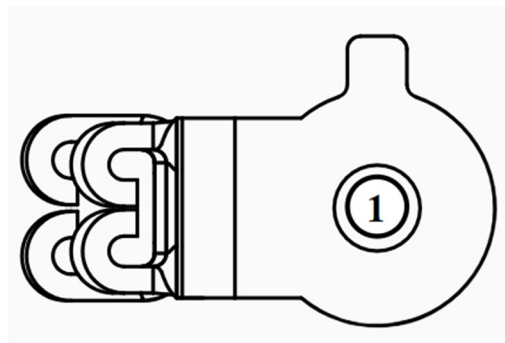

C1617C

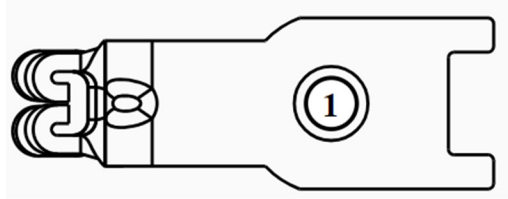

C1617F

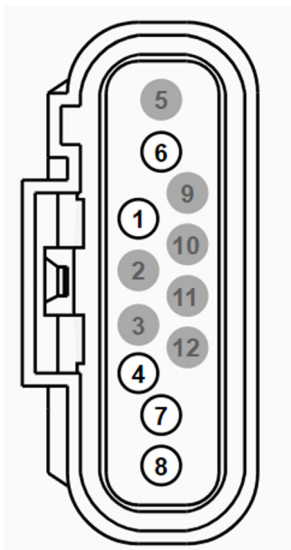

C1656

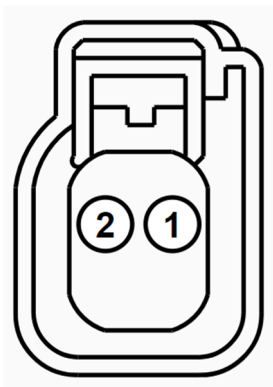

C169

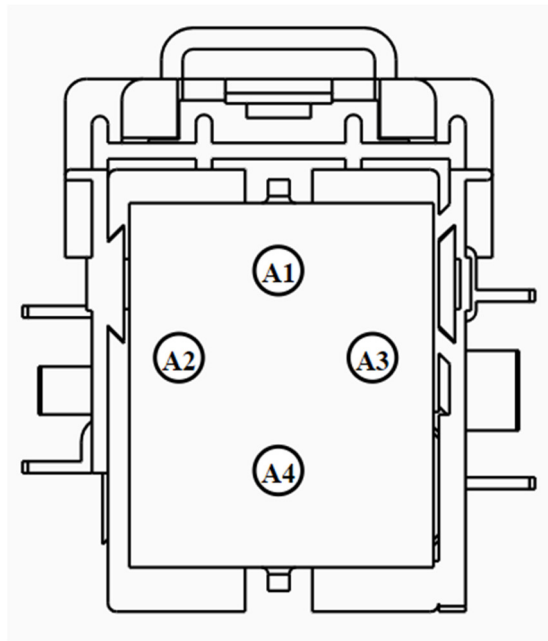

C170

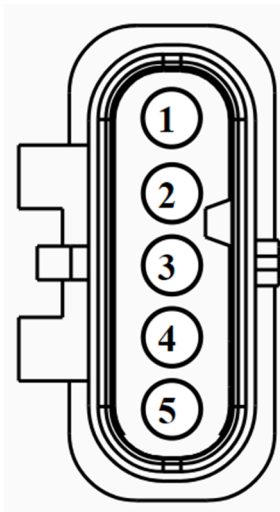

C171, C1865

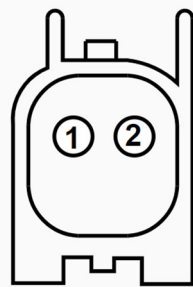

C1711, C1712

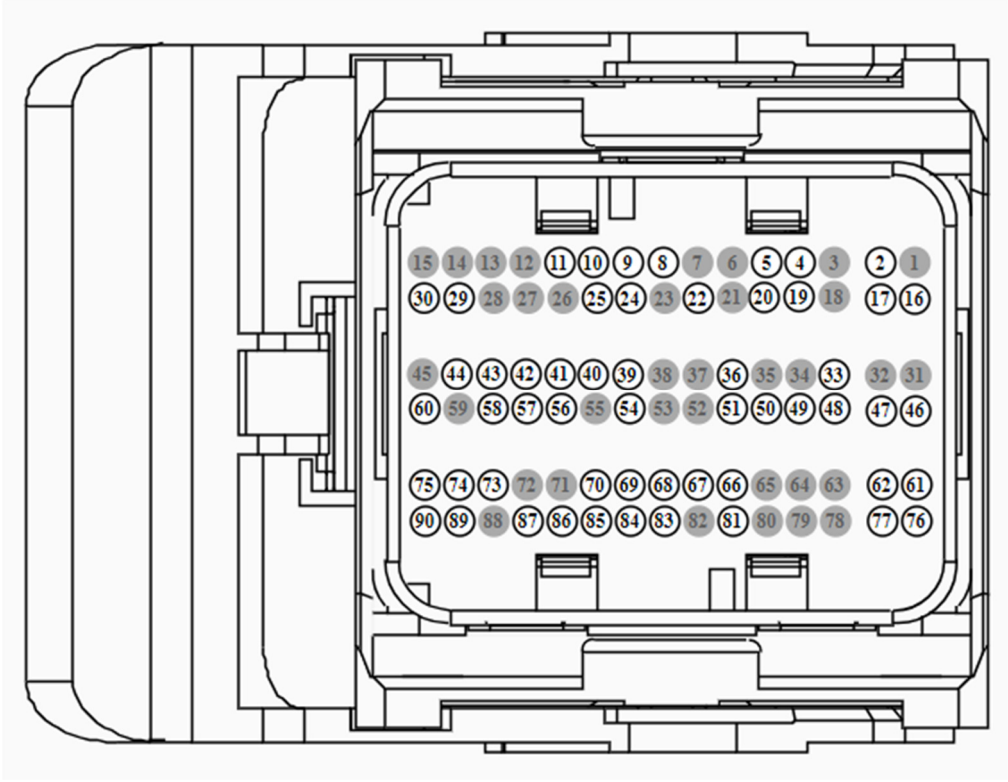

C175B

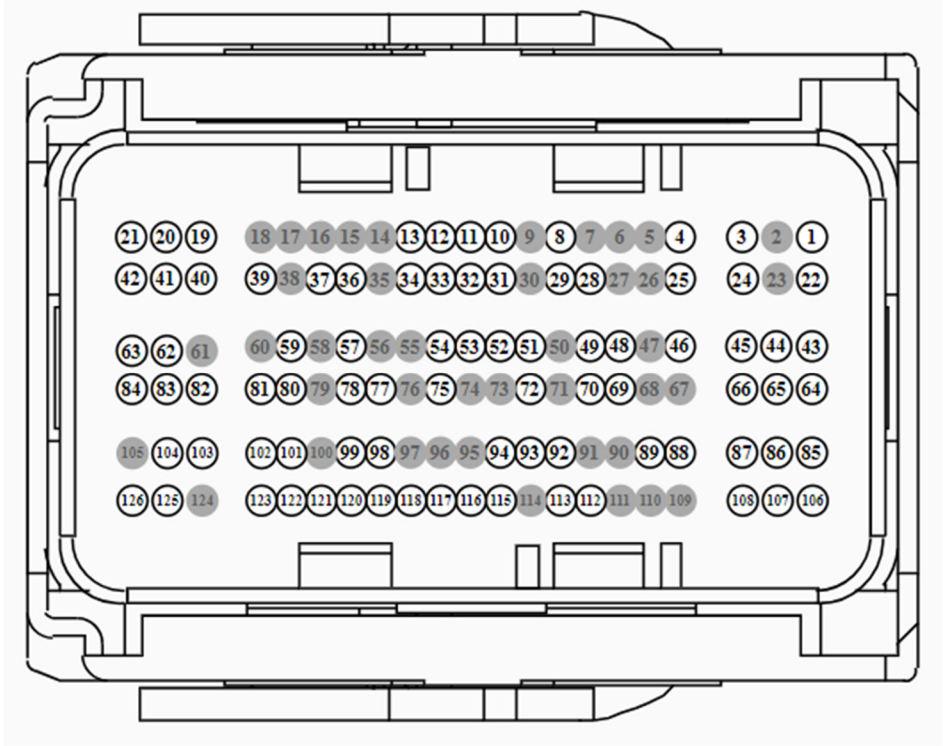

C175E

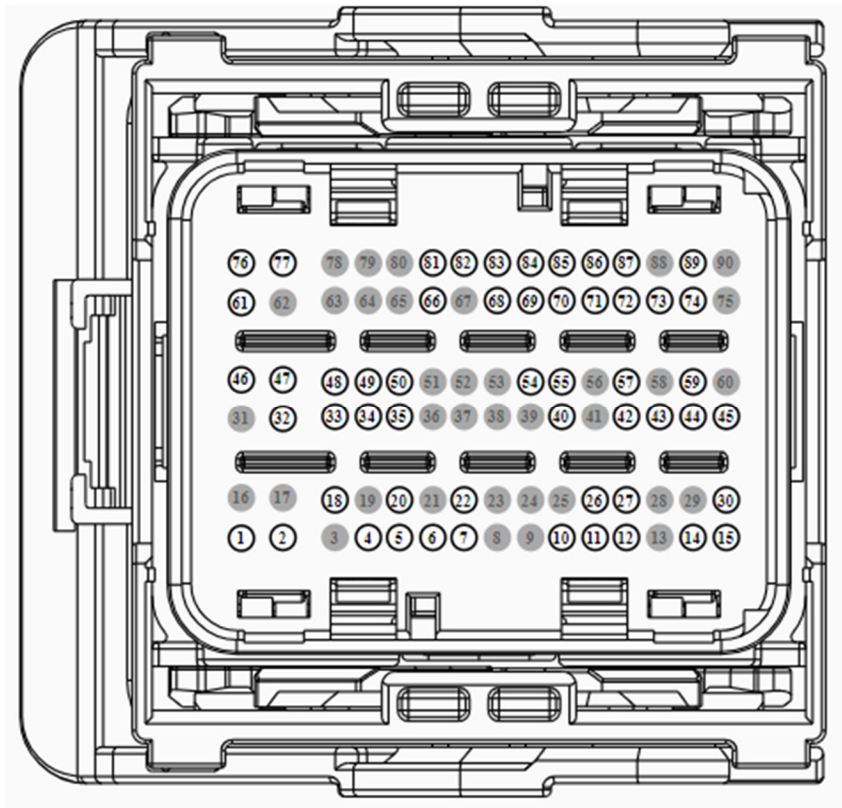

C175T

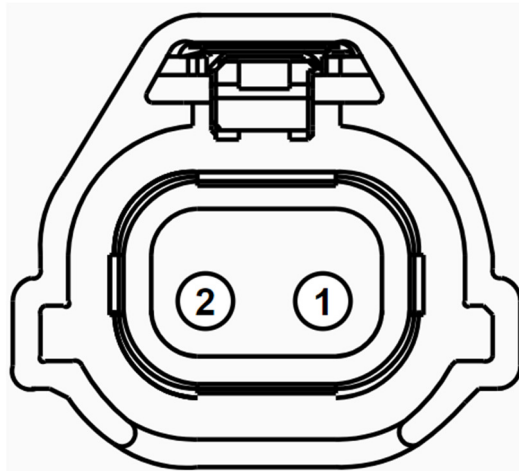

C181, C182, C183, C184, C185, C186, C187, C188

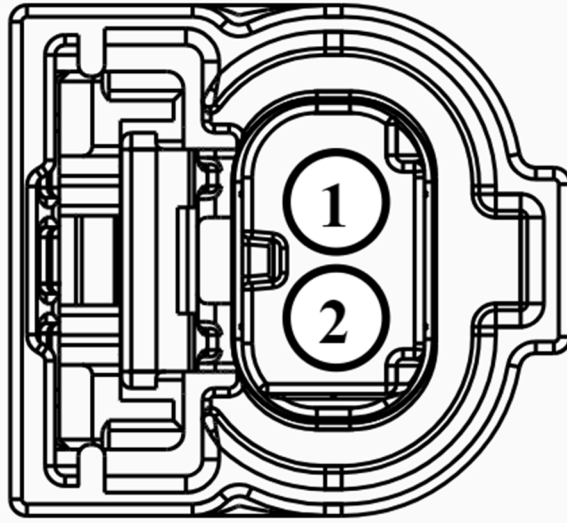

C1838, C1839, C1898, C1899

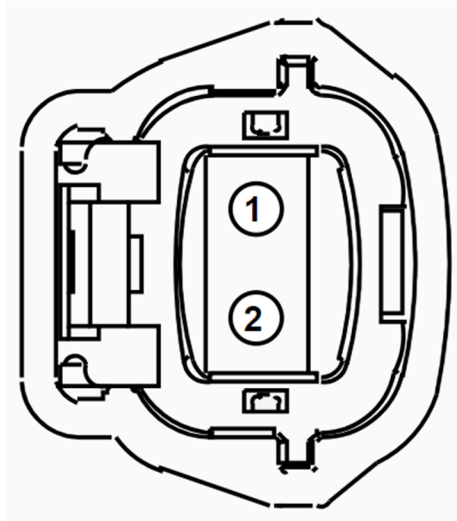

C191

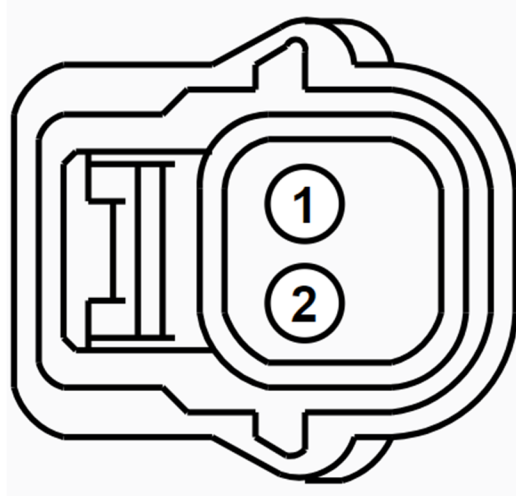

C1913

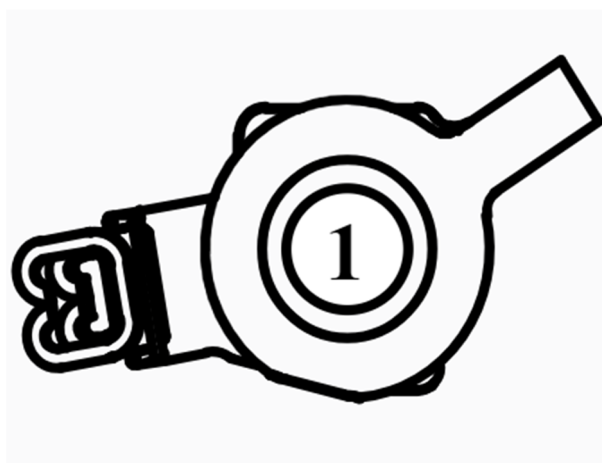

C197A

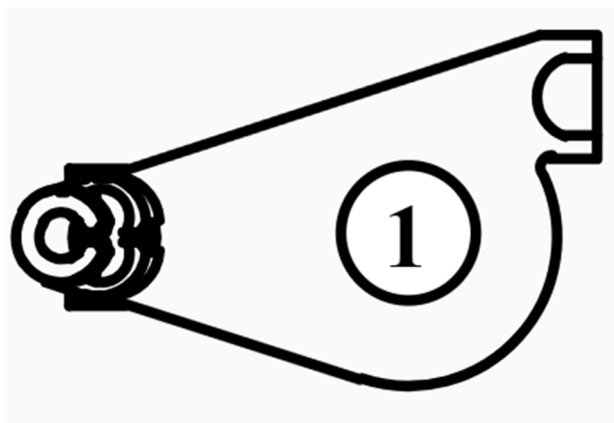

C197B

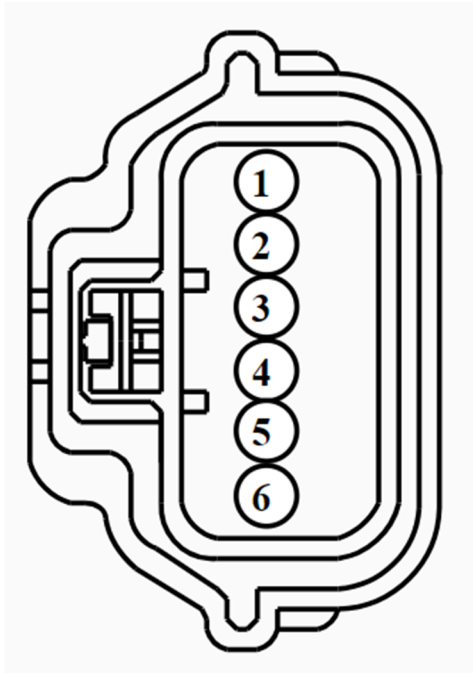

C2040

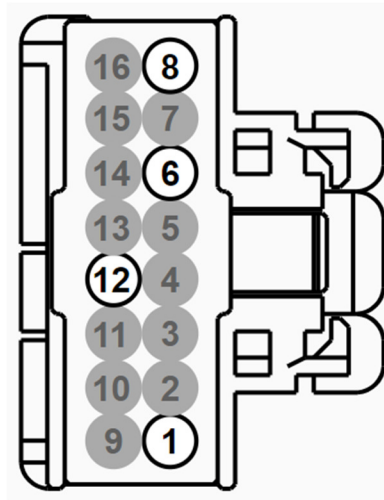

C205

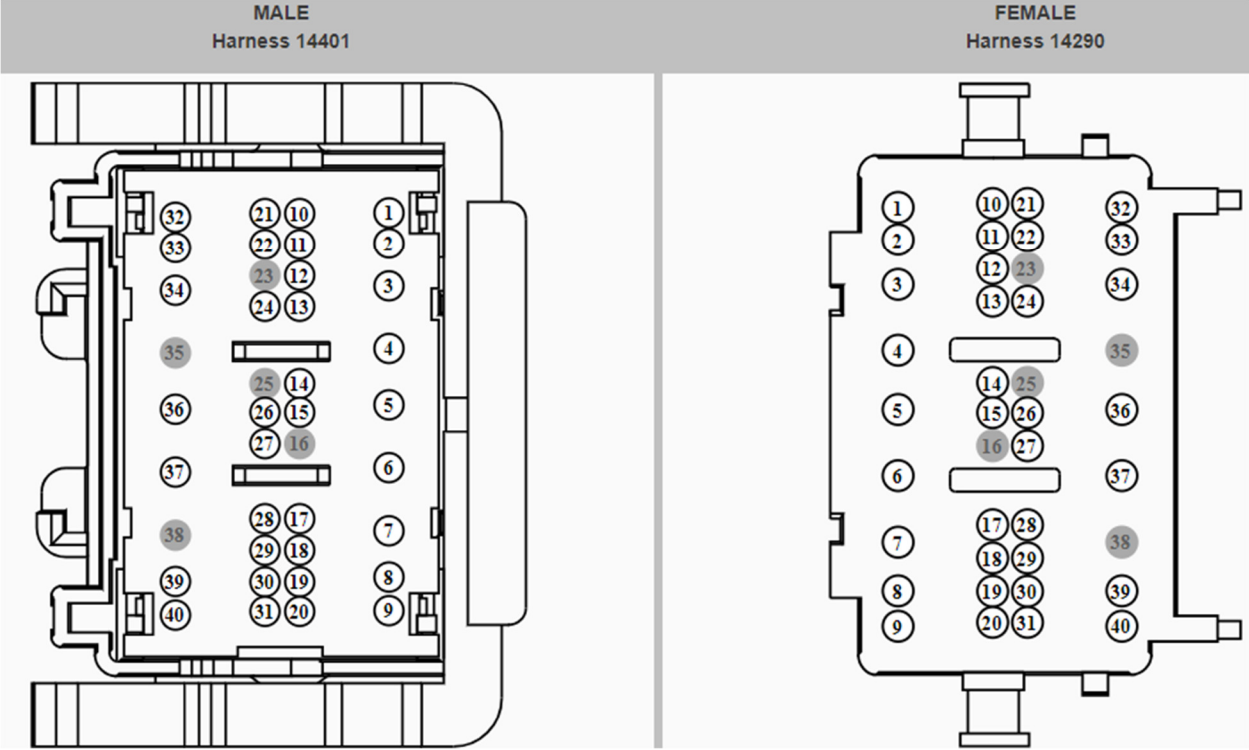

C212

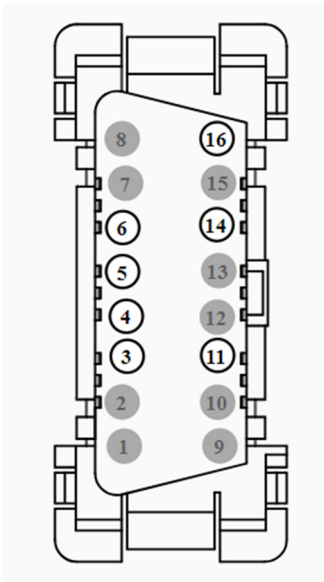

C2122

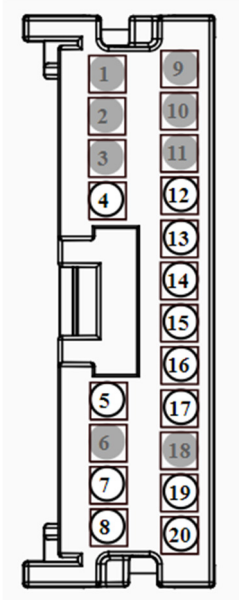

C2129

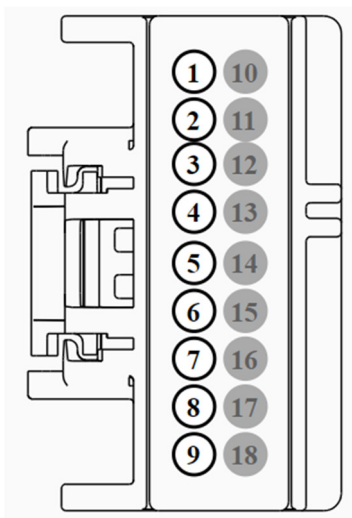

C218A

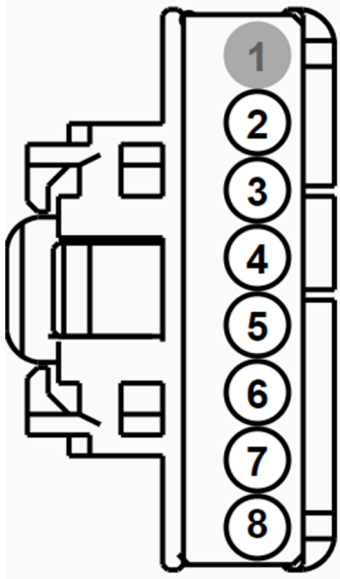

C226A

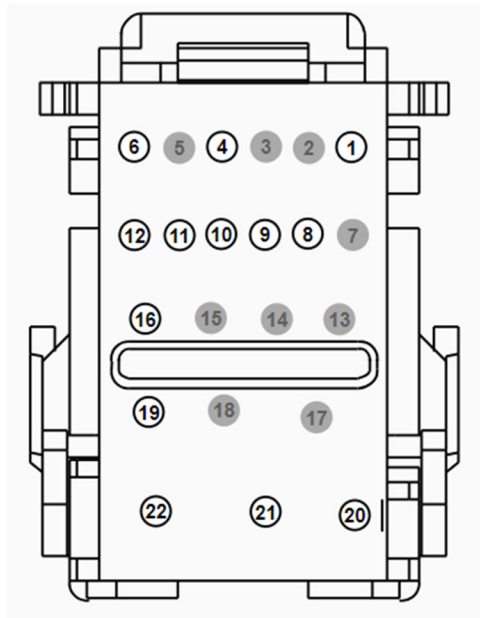

C2280A

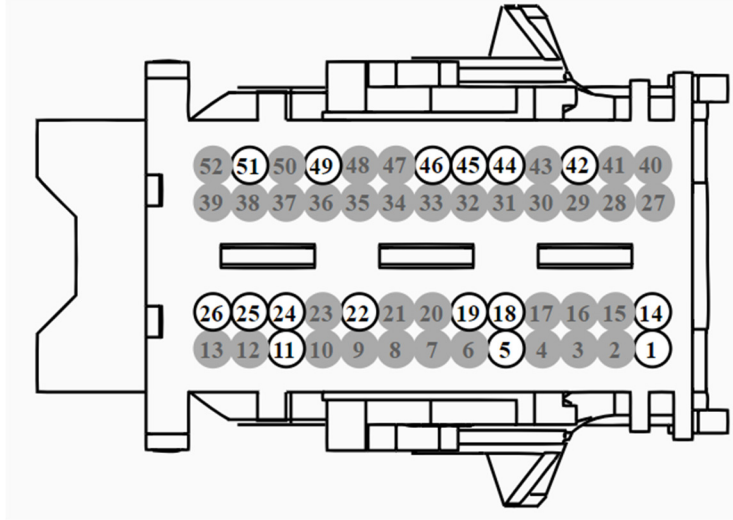

C2280B

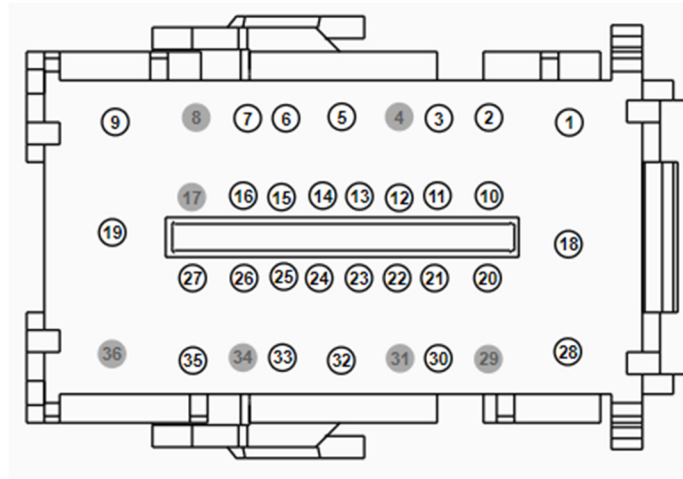

C2280C

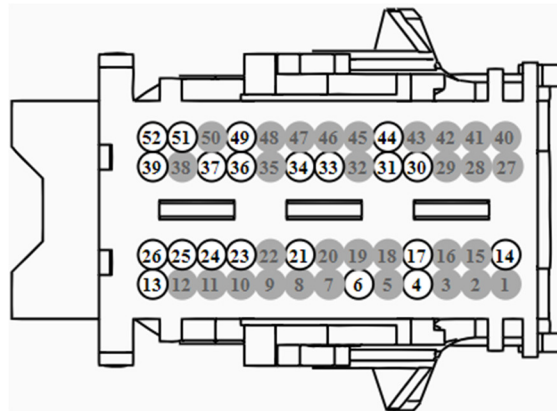

C2280E

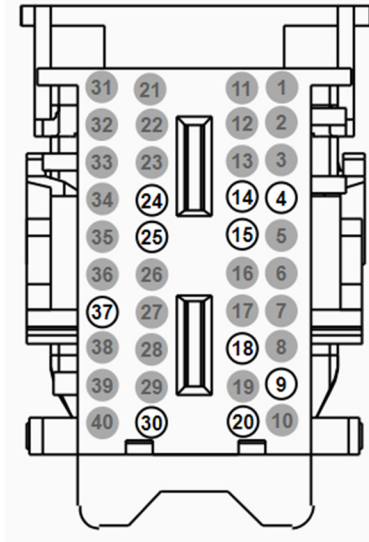

C2280F

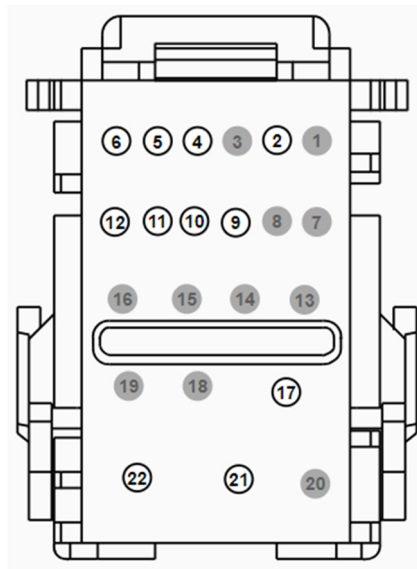

C2280G

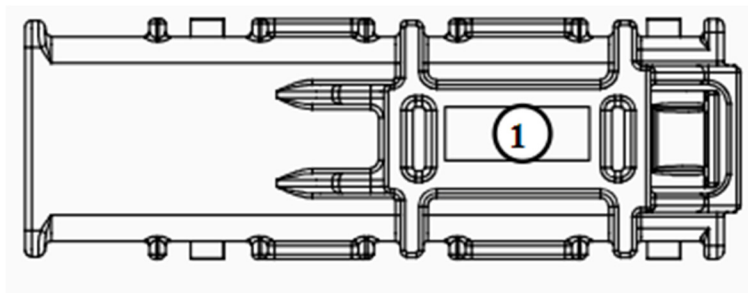

C2280H

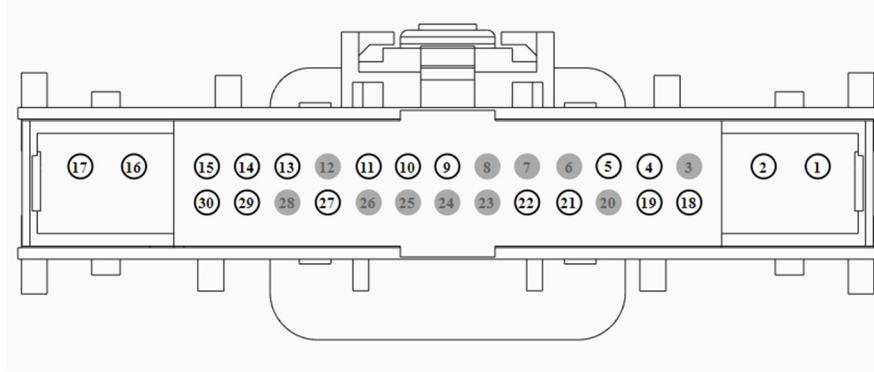

C228A

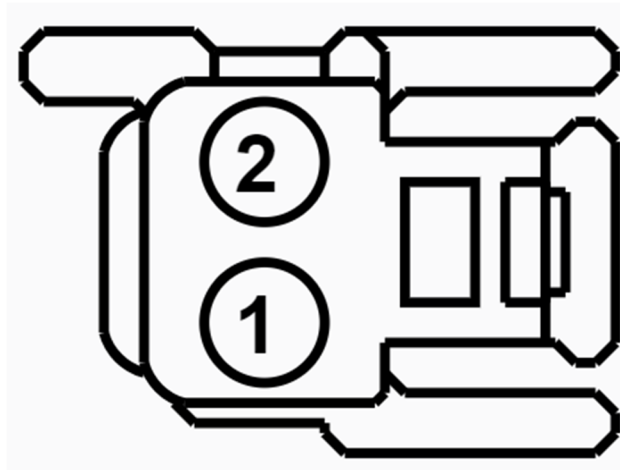

C2353

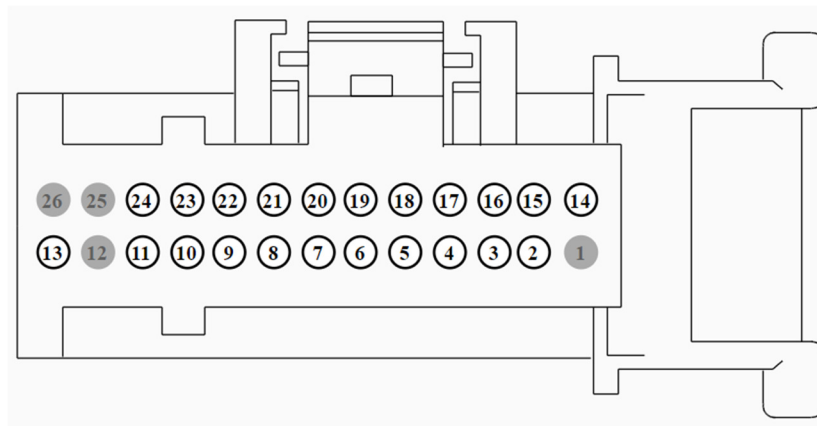

C2431A

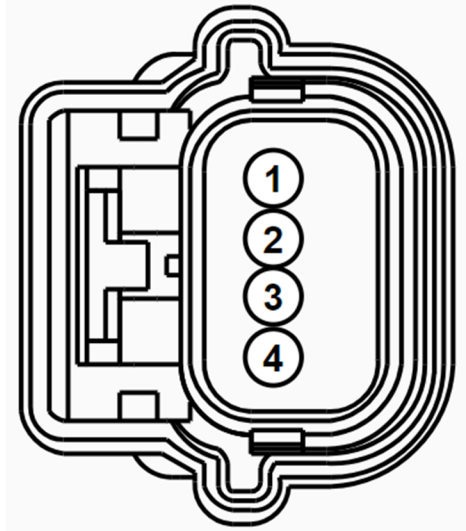

C2478

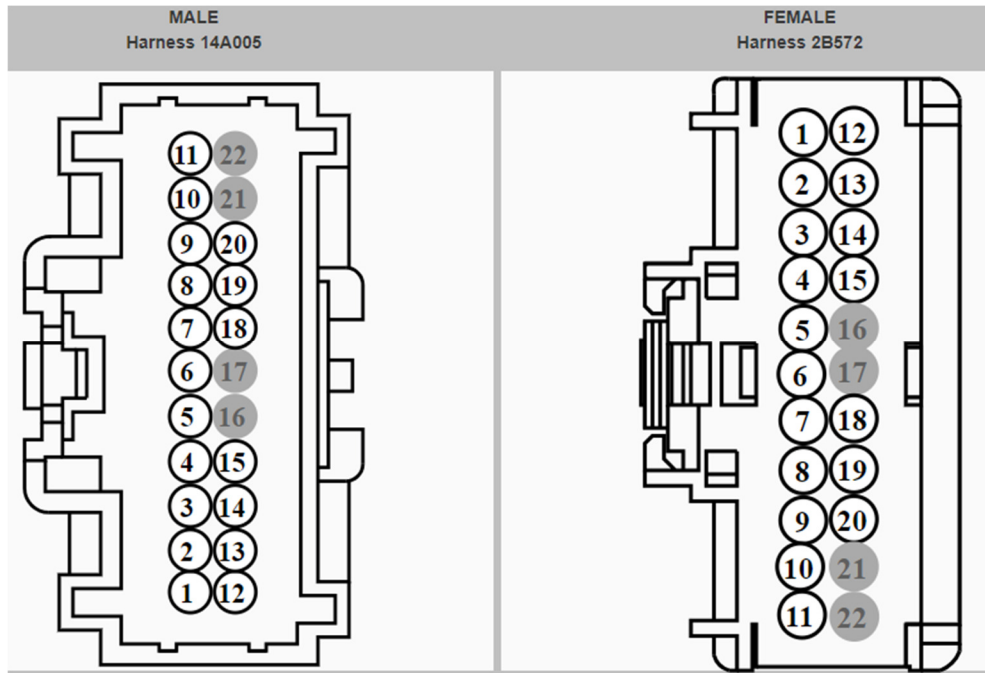

C248

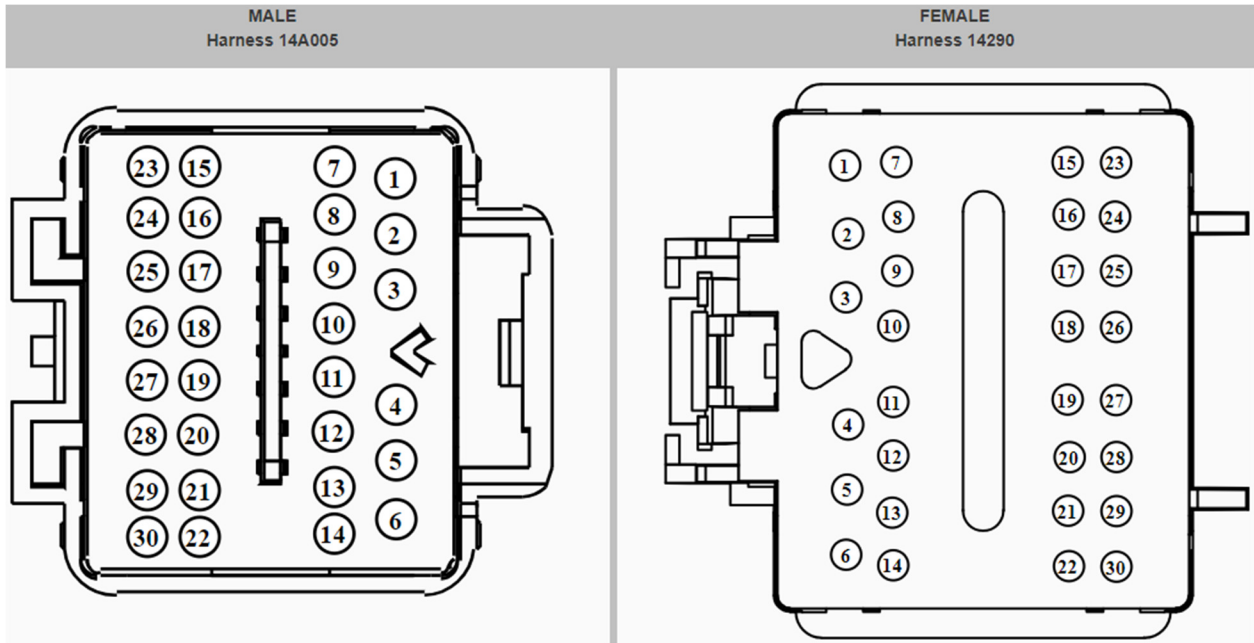

C264

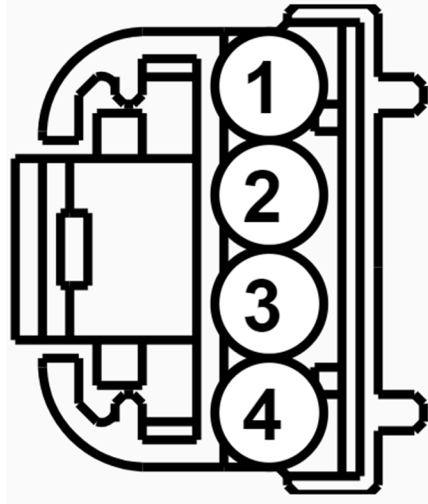

C286

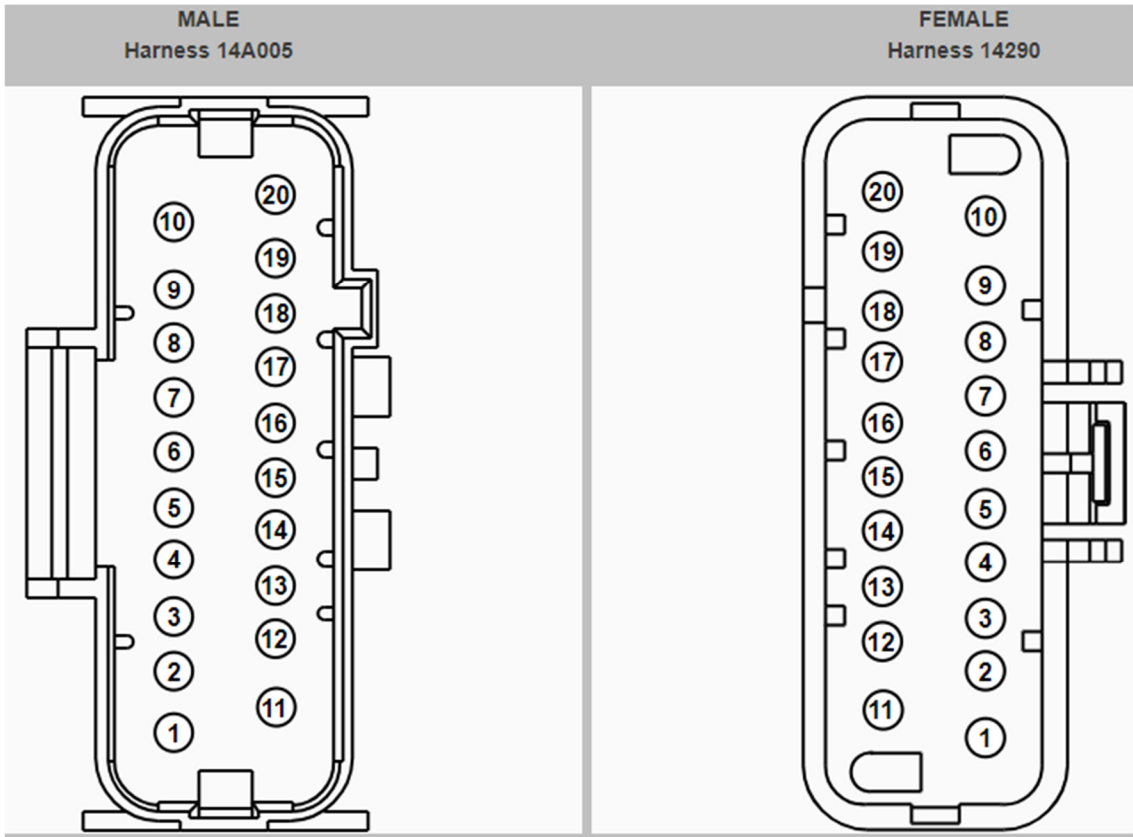

C3205

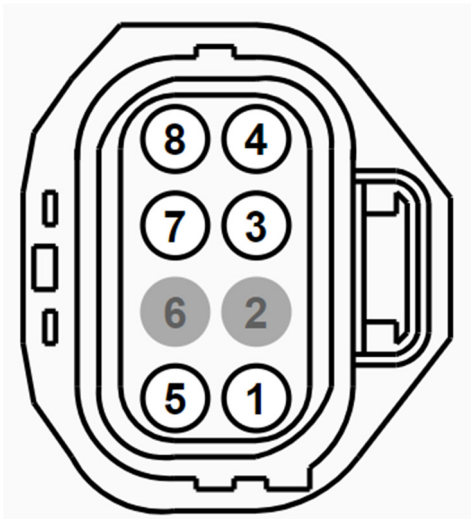

C4033

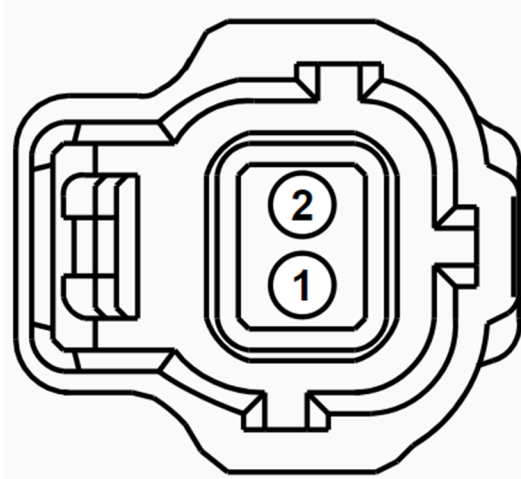

C4116

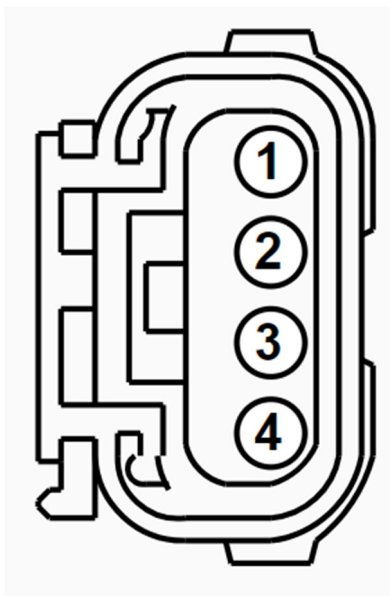

C433

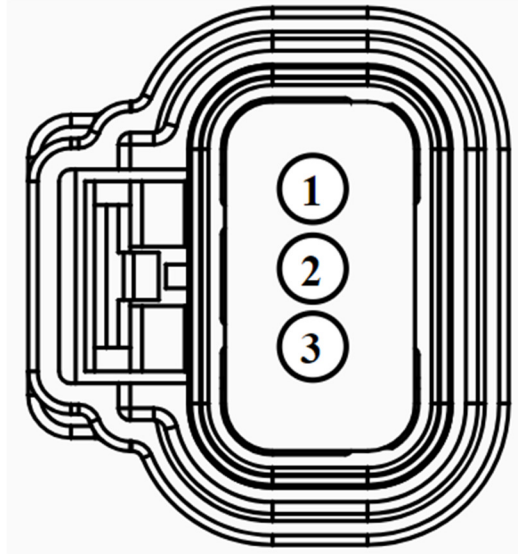

C435

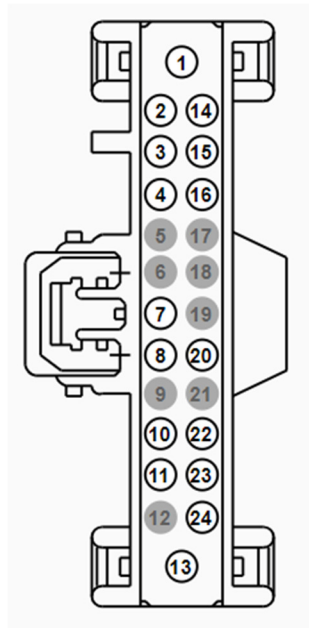

C4368A

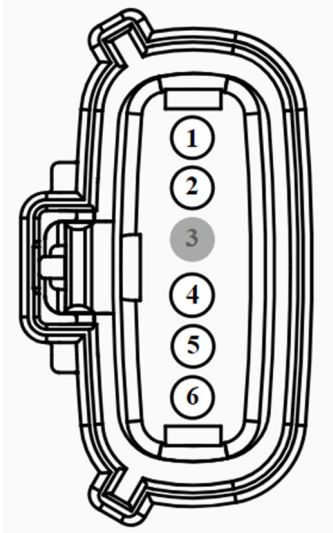

C4575

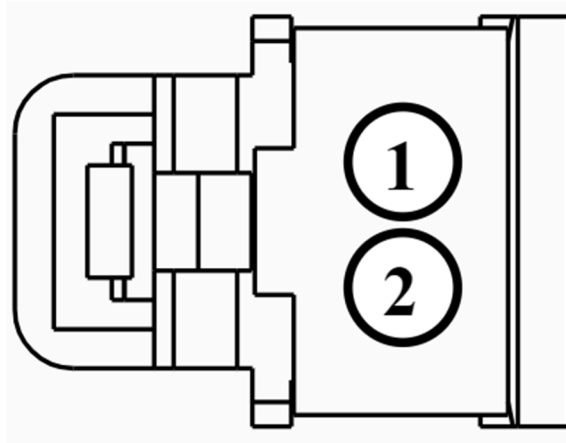

C475

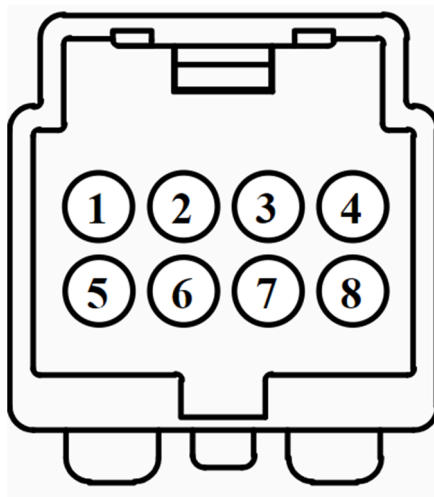

C498, C499

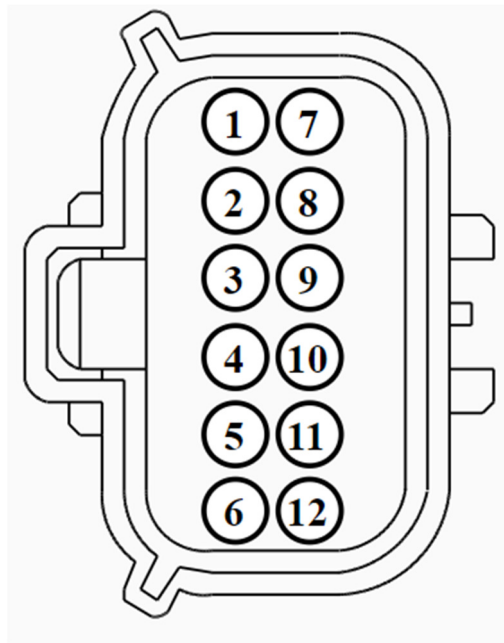

C520, C626

MALE Harness 15K867	FEMALE Harness 14290
------------------------	-------------------------

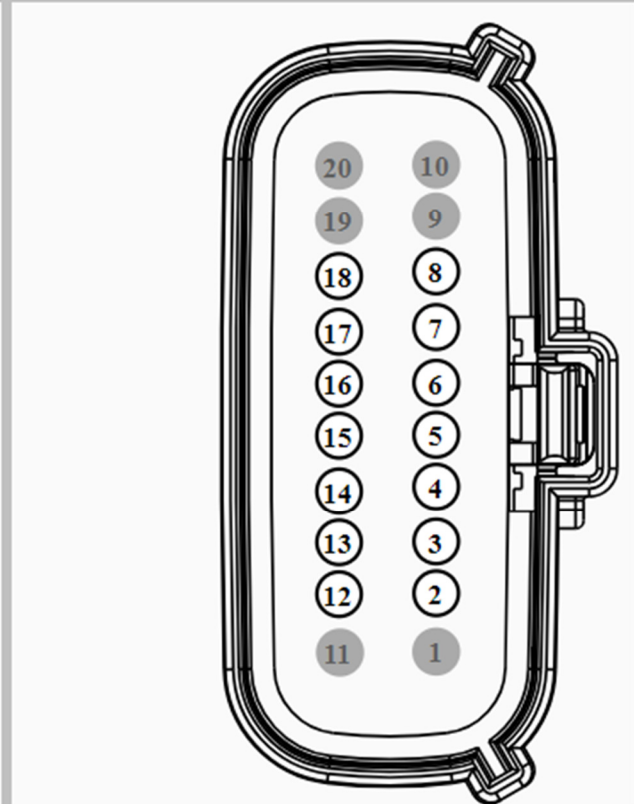
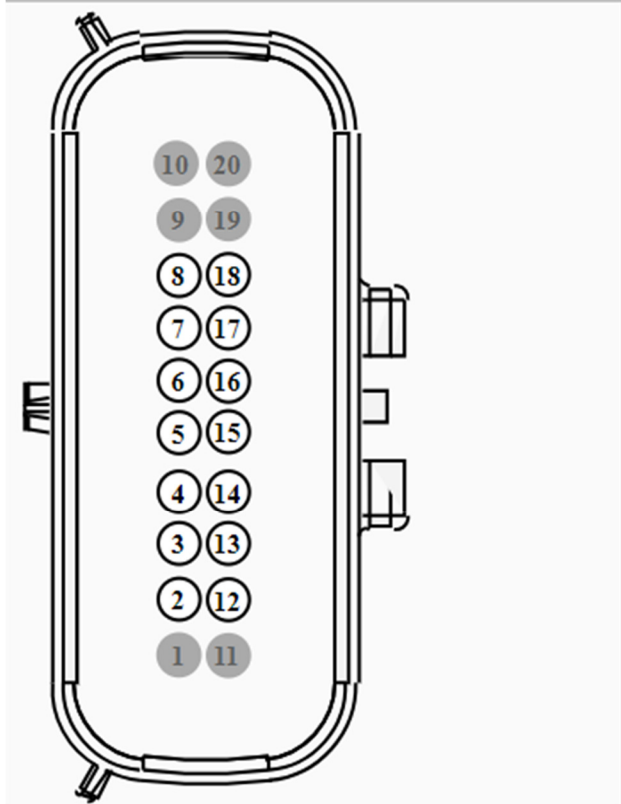

C102

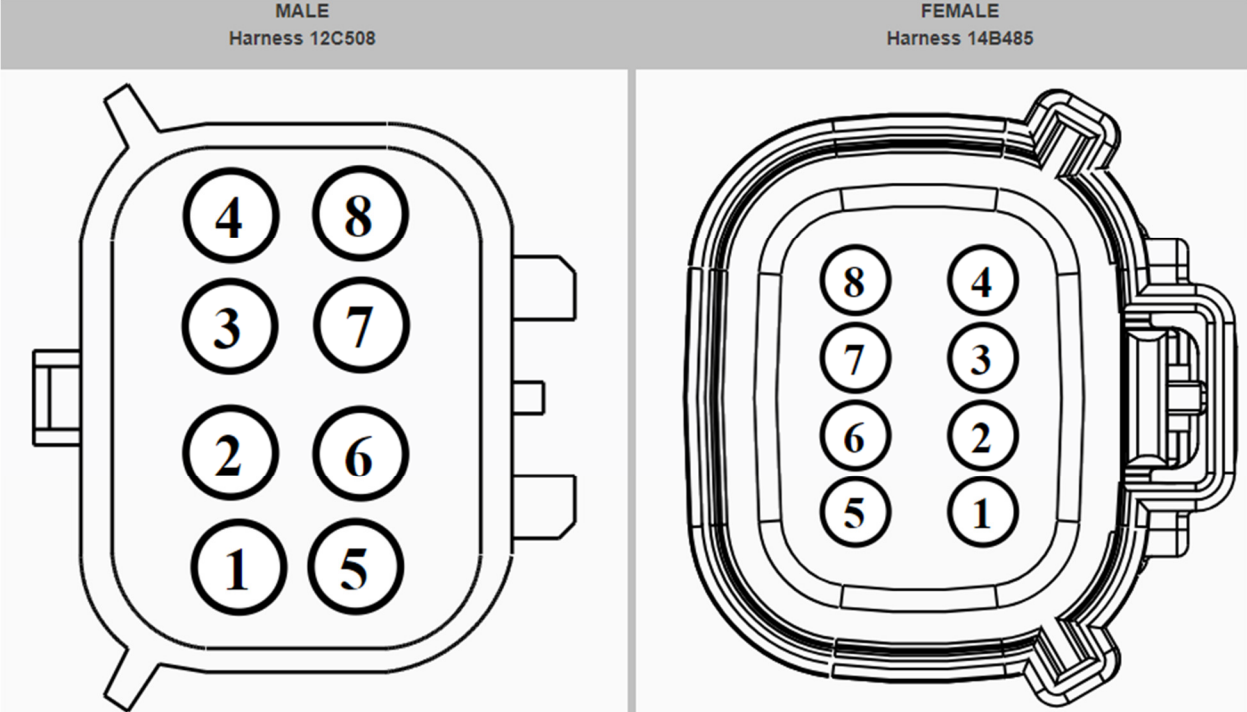

C1033

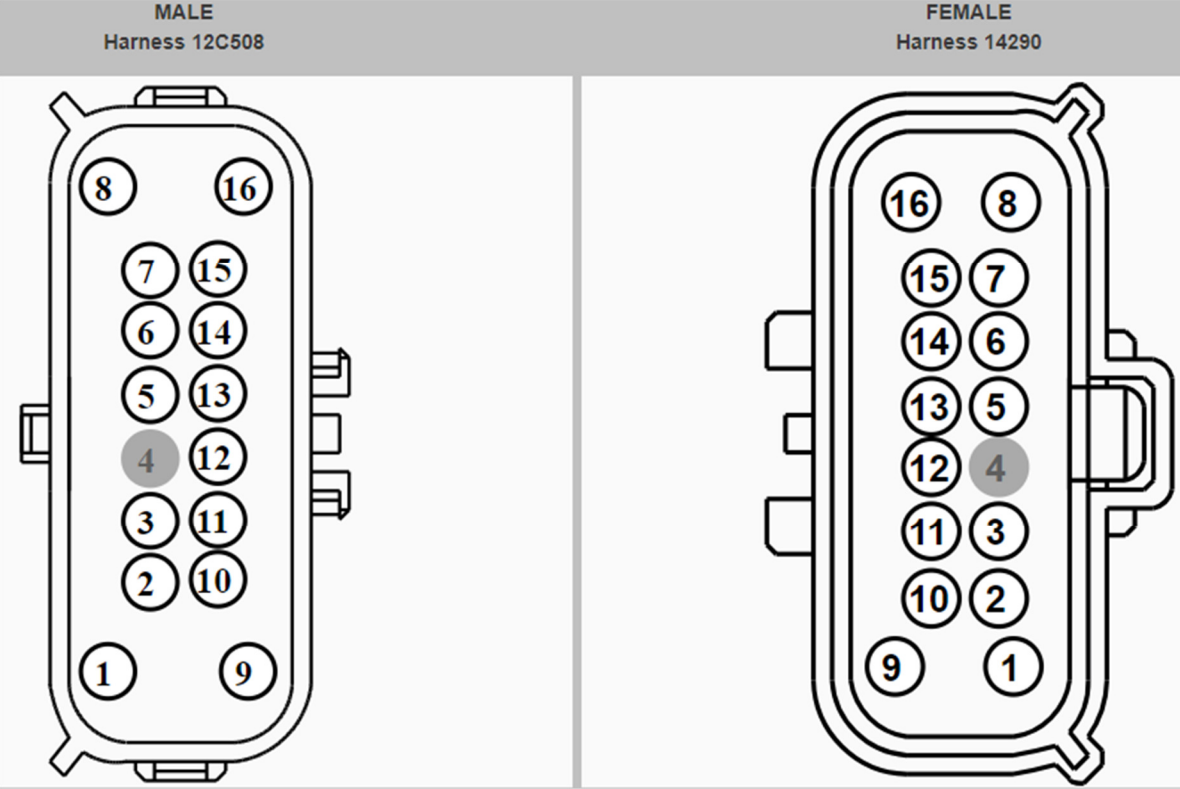

C1045

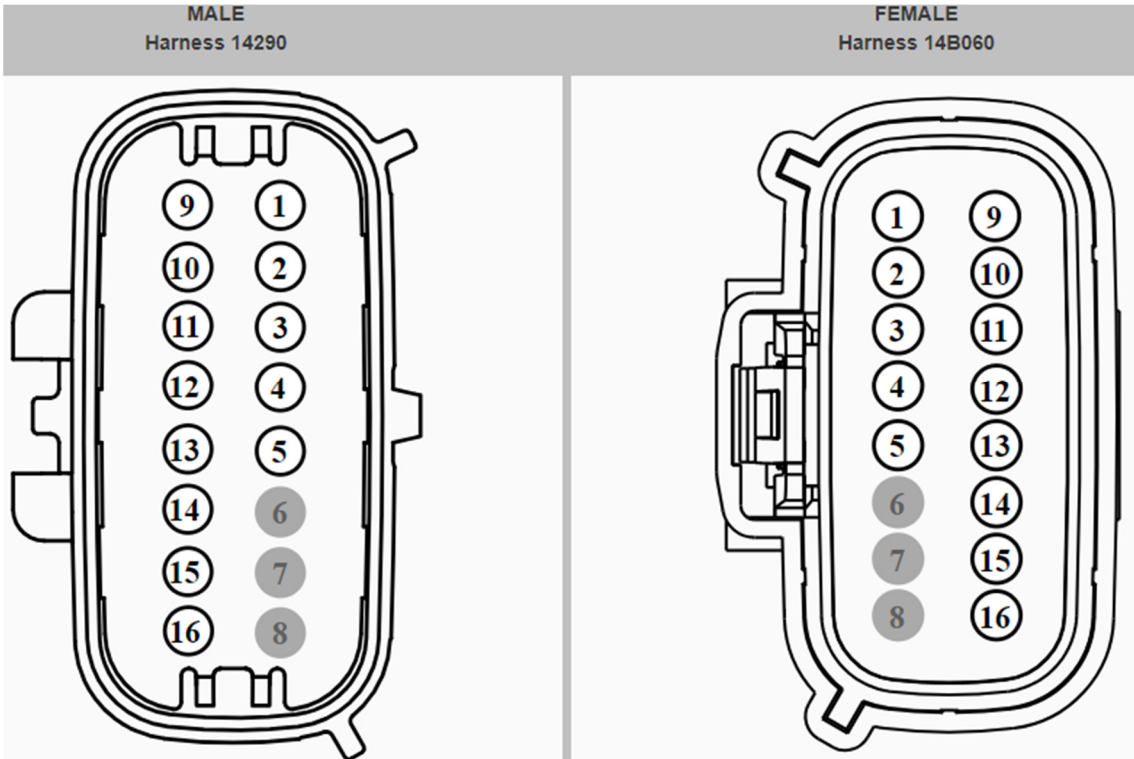

C139

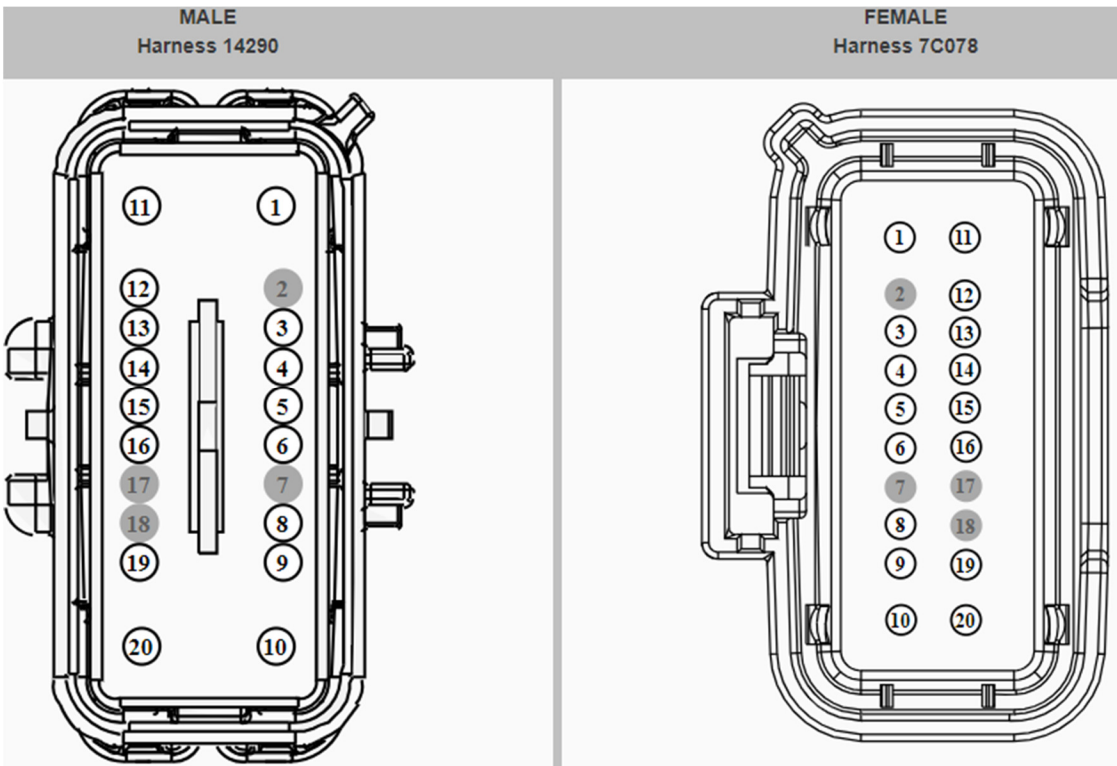

C1393

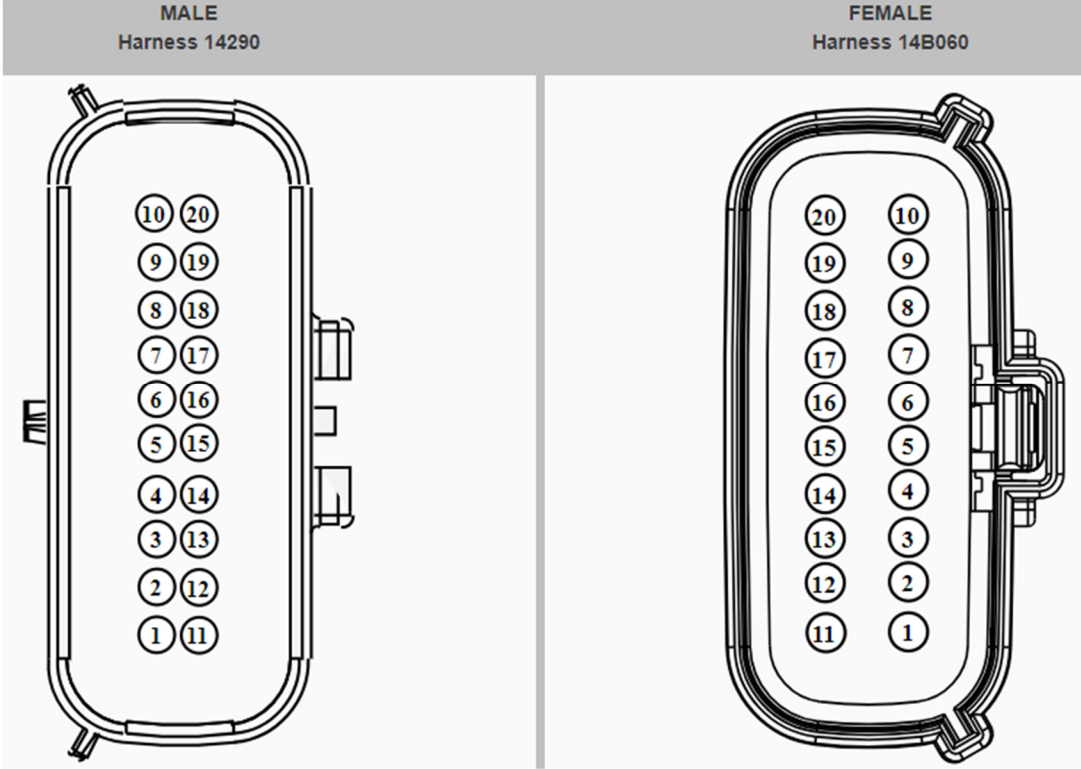

C1591

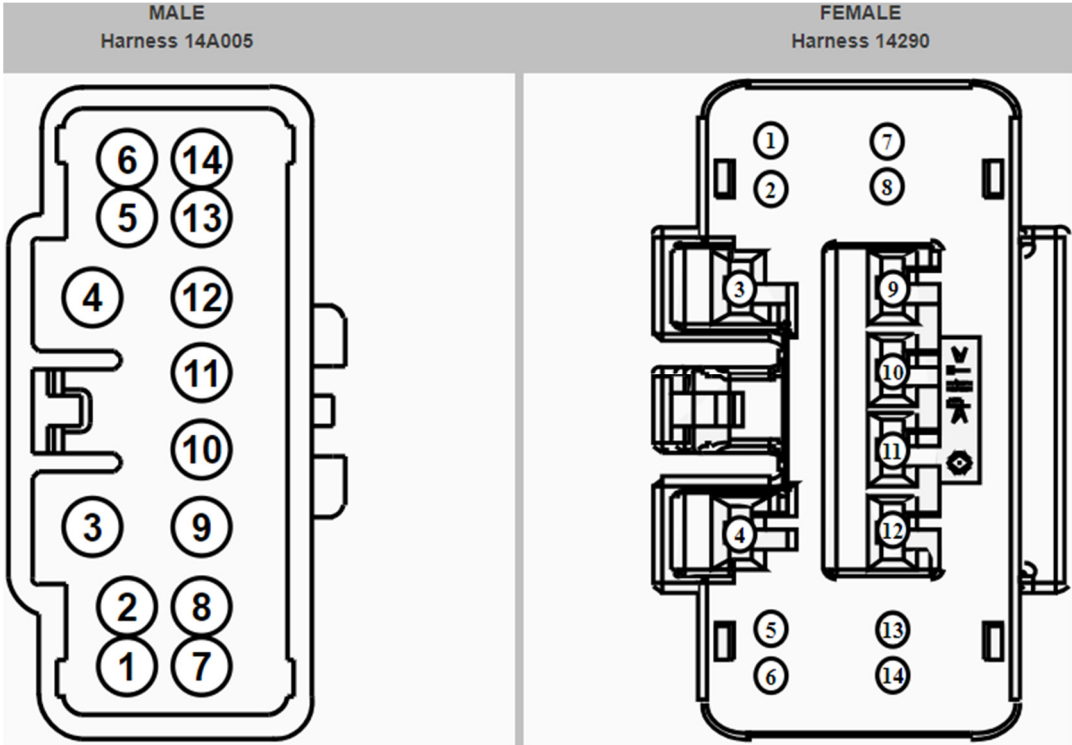

C265

MALE
Harness 14290

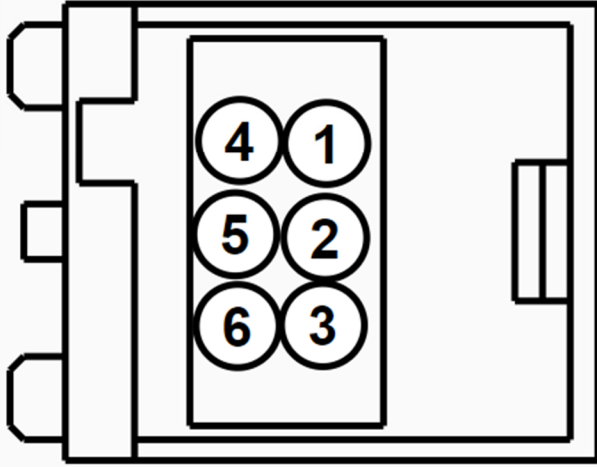

FEMALE
Harness 15K857

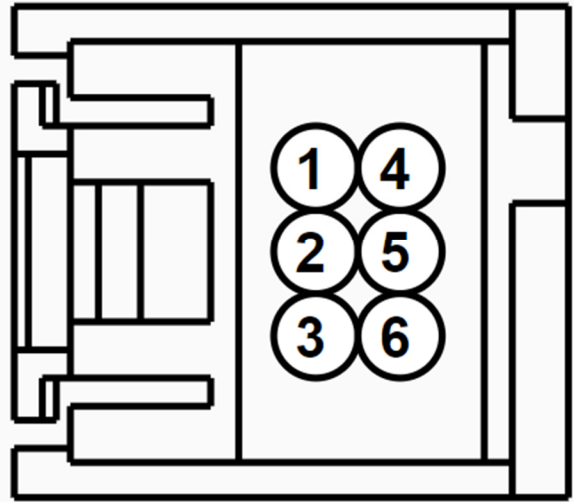

C269

MALE
Harness 14B485

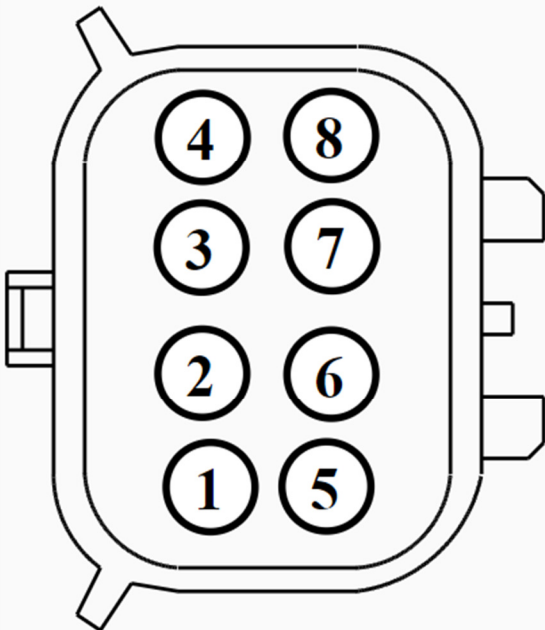

FEMALE
Harness 12C508

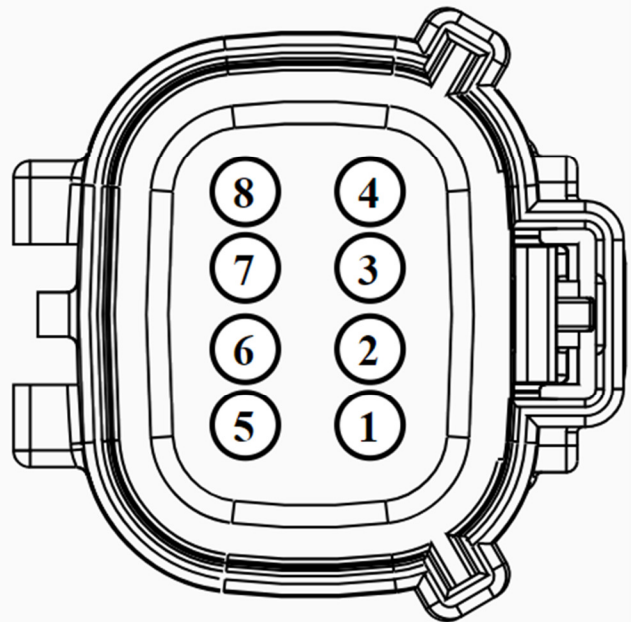

C327, C432

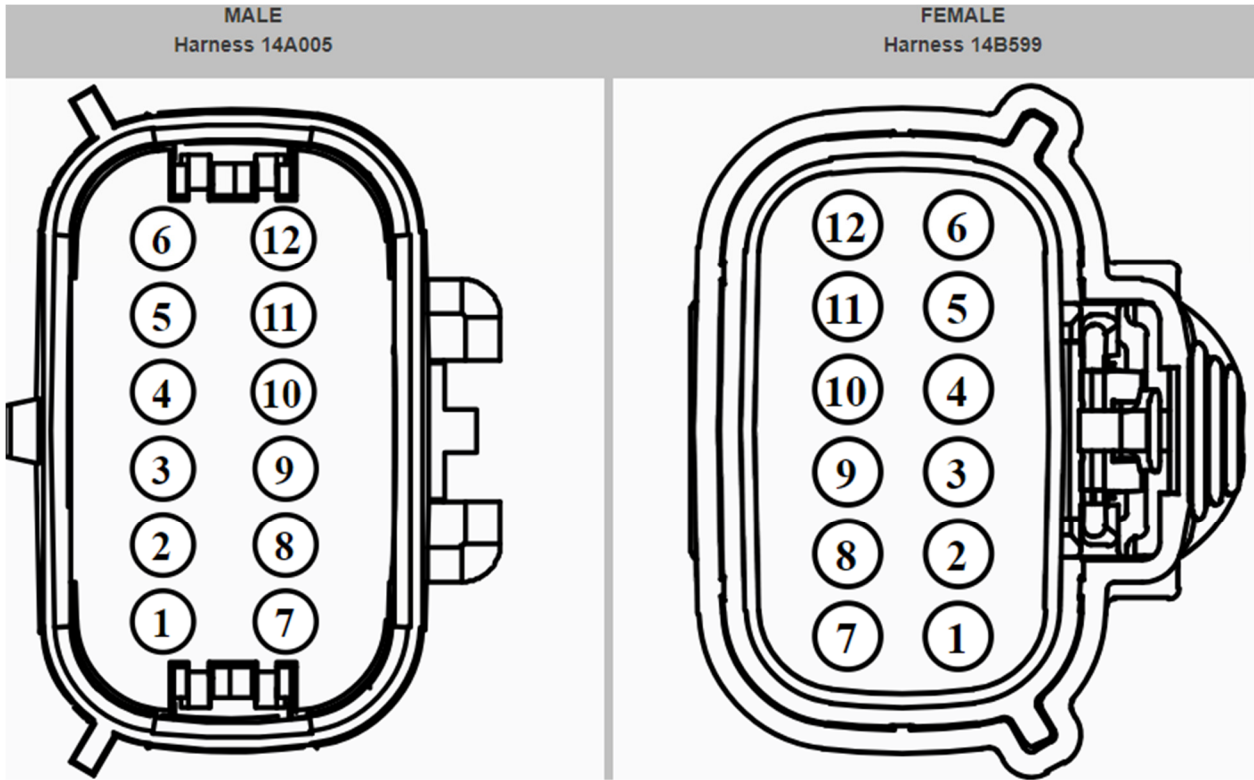

C3806

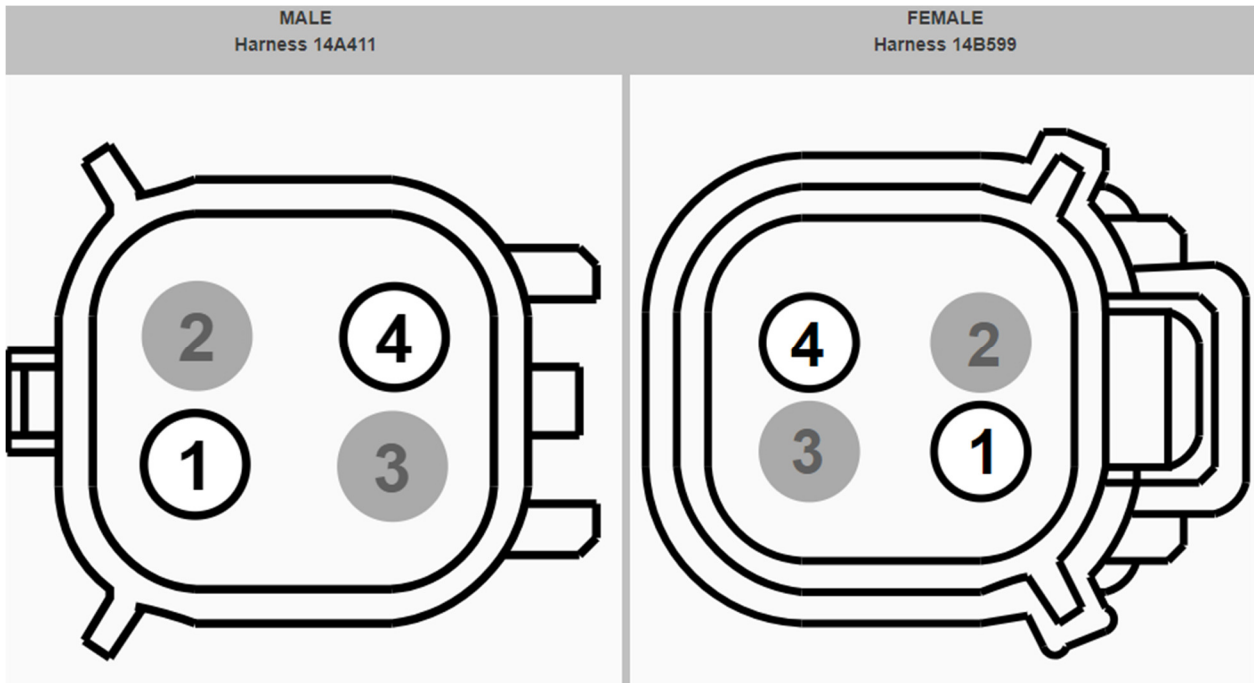

C465

