

# Mustang Dark Horse R Mustang Challenge Homologation



# Table of Contents

<b>General Notes</b> .....	5	<b>Driver Door (Cont.)</b> .....	11
<b>Interior</b> .....	6-7	Door Latch Assembly – LH.....	11
Dash Panel.....	6	Inner Door Panel – LH.....	11
Dash Panel Closeout.....	6	<b>Engine</b> .....	12-13
Center Vents Assembly.....	6	Sealed Engine.....	12
Heat Shield.....	6	Oil Cooler.....	13
Dash Panel Top.....	6	Oil Cooler Lines.....	13
Dead Pedal Kit.....	6	Catch Can Kit.....	13
OBD2 Mounting Plate.....	6	Catch Can Bracket.....	13
Rear View Mirror.....	7	Oil Cooler Adapter.....	13
Rear View Mirror Brackets.....	7	Oil Cooler Fitting Adapter Kit.....	13
Optional 5" Rear View Mirror Brackets..	7	Catch Can to Oil Pan Drain Back Hose..	13
Optional 9" Rear View Mirror Brackets..	7	Heater Hose.....	13
Optional Side View Mirror.....	7	<b>Exhaust</b> .....	14
Optional Extended Side View Mirror		Headers.....	14
Bracket.....	7	LH Collector Pipe.....	14
Ballast Cover.....	7	LH Tail Pipe.....	14
Ballast Mount w/ Hardware.....	7	X-Pipe.....	14
<b>Exterior</b> .....	8	RH Collector Pipe.....	14
Tow Hook Kit – Rear.....	8	RH Tail Pip.....	14
Hood Pins.....	8	<b>Fuel</b> .....	15
Tie Down Kit – Front / Rear.....	8	Fuel Cell Spacer.....	15
Battery Tray.....	8	Fuel Cell Bladder Assembly.....	15
Tow Hook Kit – Front.....	8	Fuel Lines and Fittings.....	15
Rear Deflector.....	8	Ball Locking Break Socket (Red).....	15
Exterior Power Panel (Master Power /		Fuel Cell Lid.....	15
Fire Suppression Pull Cable).....	8	Plate (Fuel Pump Block Off).....	15
Transponder Bracket.....	8	Fuel Line Fitting.....	15
<b>Front</b> .....	9	Ball Locking Break Plug (Red).....	15
Front Fascia Assembly.....	9	<b>Frame / Mounting</b> .....	16
Cowl Top Assembly.....	9	Front Subframe (K Member).....	16
Brake Duct Mounting Bracket.....	9	Rear Subframe.....	16
Brake Duct Hose Kit.....	9	<b>Suspension</b> .....	17-19
Radiator Closeout.....	9	Bearing Kit for Control Arms - Front /	
Brake Duct Inlets.....	9	Rear.....	17
<b>Trunk / Rear</b> .....	10	Arm LH - Lower Front Assembly.....	17
Trunk Latch.....	10	Adjustable Link (Front Anti Roll Bar).....	17
Rear Closeout.....	10	Arm RH - Lower Front Assembly.....	17
Rear Fascia.....	10	Front Brake Line Bracket.....	17
Wing Wicker.....	10	Wheel Stud & Nut Kit – Front / Rear.....	17
<b>Driver Door</b> .....	11	Knuckle / Bearing Assembly LH.....	18
Door Foam – LH.....	11		

# Table of Contents (Cont.)

<b>Suspension (Cont.)</b> .....	<b>17-19</b>	<b>Driveline (Cont.)</b> .....	<b>24-25</b>
Upper Shock Mount – RH / LH.....	18	Shifter Kit.....	24
Lower Shock Mount Assembly, Bottom	18	Clutch Master Feed Kit.....	24
Rear Adjustable Drop Link.....	18	Half Shaft .....	24
Knuckle / Bearing Assembly RH.....	18	Transmission Cooler Lines.....	24
Lower Shock Mount, Top.....	18	Drive Shaft Loop Kit – Front.....	25
Rear Adjustable Toe Link Assembly.....	18	Differential Pump.....	25
Rear Lower Control Arm LH.....	19	Differential Cooler and Fan Unit.....	25
Rear Lower Control Arm RH.....	19	Filter Screen for Differential Cooler.....	25
<b>Dampers</b> .....	<b>20</b>	Drive Shaft Loop Kit - Rear.....	25
Spring, Rear.....	20	Bracket (Diff Pump to Body) .....	25
Spring Bearing Kit, Rear (2") .....	20	Diff Cooler and Fan Unit Bracket.....	25
Front Damper - LH.....	20	Differential Cooler Lines.....	25
Rear Damper – LH/RH.....	20	<b>Steering</b> .....	<b>26</b>
Spring, Front.....	20	Steering Wheel.....	26
Spring Bearing Kit, Front (2.5") .....	20	Steering Hub.....	26
Front Damper - RH.....	20	Steering Wheel Hook.....	26
Front Camber Adjuster Plates.....	20	Multifunction Switch.....	26
<b>Brakes - ABS</b> .....	<b>21</b>	Quick Release w/ Hardware.....	26
Dark Horse R ABS M5 Clubsport Kit....	21	<b>Wheels &amp; Tires</b> .....	<b>27</b>
ABS Sensor - Front LH.....	21	Wheels.....	27
Front ABS Wire Hanger LH / RH.....	21	Tires - Slick.....	27
ABS Bracket.....	21	Tires - Wet.....	27
MSA Box, Signal Converter.....	21	<b>Data</b> .....	<b>28</b>
ABS Sensor - Front RH.....	21	Data System, MC187.....	28
ABS Wire Bracket LH / RH.....	21	Data System Bracket.....	28
<b>Brakes – Front</b> .....	<b>22</b>	Oil / Trans Temperature Sensor.....	28
Brake Pad.....	22	Data System GPS Antenna.....	28
Front Caliper Bracket w/ Hardware.....	22	ProCal 4.....	28
Front Brake Backing Plate LH / RH Kit..	22	Optional Shift Light Module.....	28
Brake Pad.....	22	<b>Electrical</b> .....	<b>29-31</b>
Front Caliper – LH / RH.....	22	Battery Harness, Modified.....	29
Brake Disc Assembly.....	22	Breaker to Relay Cable.....	29
<b>Brakes - Lines</b> .....	<b>23</b>	Main Breaker.....	29
Master Cylinder to ABS - Front.....	23	Relay.....	29
Master Cylinder to ABS - Rear.....	23	Battery to Breaker Cable.....	29
Front Brake Line – LH / RH.....	23	PDB Harness, Modified.....	29
Rear Brake Lines – LH / RH.....	23	Front Loom.....	29
Flexible Brake Lines.....	23	Cockpit Loom.....	29
<b>Driveline</b> .....	<b>24-25</b>	IP (Dash) Harness, Modified.....	30
SS Clutch Line.....	24	Switch Panel / Harness.....	30
Transmission / Differential Vent.....	24	PTT Jumper Harness.....	30

# Table of Contents (Cont.)

<b>Electrical (Cont.)</b> .....	<b>29-31</b>	<b>Appendix (Cont.)</b> .....	<b>35-93</b>
Door Harness - RH.....	30	Ride Height Reference Points.....	51
Body Harness.....	30	Radio.....	52
Master Power Panel.....	30	Yellow Flag Warning System.....	53
Steering Wheel Switch Plate / Harness.....	30	Transponder System.....	54
Door Harness - LH.....	30	Incident Data Recorder.....	55
Diff Pump Jumper Harness.....	31	Camera System.....	56-57
Can Bridge Module.....	31	Engine Seals.....	58
Diff Temp / Rear Chassis Harness.....	31	Transmission / Rear Axle Seals.....	59
CAN Jumper Harness (Underhood).....	31	Grill Mesh.....	60-61
Fuel Pump Jumper Harness.....	31	Driver Cooling System.....	62-63
HS2-CAN Jumper.....	31	Engine Cooling Modifications.....	64
CAN Jumper Harness (IP).....	31	Radiator.....	65
<b>Safety Equipment</b> .....	<b>32-33</b>	Under Hood / Trunk.....	66
Driver Safety Harness.....	32	Interiors.....	67
Safety Seat Bracket.....	32	Front Wheel Well.....	68
Driver Window Net.....	32	Rear Wheel Well.....	69
Helmet Support Net, Left Side.....	32	Bill of Materials.....	70-92
Safety Seat.....	32	Change Log.....	93
Window Net Mounting Kit.....	32		
Helmet Support Net, Right Side.....	32		
Roll Bar Padding.....	32		
Fire Bottle.....	33		
Fire Suppression Lines.....	33		
<b>Recommended Fluids</b> .....	<b>34</b>		
Gear Lubricant, Motorcraft 75W-85.....	34		
Coolant, Motorcraft Gold 50/50.....	34		
Brake Fluid, Brembo HTC64.....	34		
Motor Oil, Motorcraft 5W-50.....	34		
Trans Fluid, Motorcraft Mercon LV.....	34		
<b>Appendix</b> .....	<b>35-93</b>		
Driver Safety Harness.....	36		
Seat Mounting.....	37		
Optional Seat / Mount.....	38		
Window Nets.....	39-40		
Padding.....	41		
Master Power Electrical Switch.....	42		
Fire Suppression System.....	43		
Ballast.....	44		
Air Jack System.....	45-49		
Springs.....	50		

# General Notes

- This homologation document may be updated if vehicle specification changes are made.
- Updates will be available on the Ford Performance Mustang Challenge website.  
Link: [Competitor Info \(ford.com\)](https://ford.com)
- Adjustments or modifications not specified in this document are not allowed.
- The only optional equipment allowed is shown in this document.
- All parts on vehicle must be production Ford Mustang Dark Horse components unless specifically listed in this document as detailed in the Bill of Materials.
- Mustang Challenge fluids are unrestricted. The recommended fluids are listed in this document.
- Valve stem specification is open. Valve stem caps are required.

# Interior



Dash Panel  
DHR-DASH-MOD



Dash Panel Top  
DHR-DASH-MOD



Dash Panel Closeout  
DHR-DASHCLOSEOUT



Center Vents Assembly  
WMOD-C044K30-FB319W



Heat Shield  
DHR-FLOOR-HT-SHLD



Dead Pedal Kit  
WR-DEADPEDAL



OBD2 Mounting Plate  
DHR-OBD2-MNT-PLT

# Interior



Ballast Cover  
20017-03-0182AA01



Ballast Mount w/ Hardware  
200171-14-0000



Rear View Mirror  
JOES-11284



Rear View Mirror Brackets  
JOES-11284



Optional 5" Rear View Mirror Brackets  
JOES-11264



Optional 9" Rear View Mirror Brackets  
JOES-11294



Optional Side View Mirror  
JOES-11214



Optional Extended Side View Mirror Bracket  
JOES-11234

# Exterior



Tow Hook Kit – Rear  
FP-17954-RDH



Tow Hook Kit – Front  
FP-17654-FDH



Hood Pins  
120-4000



Rear Deflector  
DHR-AIRDEFLCTR-MOD



Tie Down Kit – Front / Rear  
M-1700-M



Exterior Power Panel (Master Power / Fire Suppression  
Pull Cable)  
DHR-EXTRPWRPNL



Battery Tray  
DHR-BATBOX-MOD



Transponder Bracket  
DHR-LAPSBKRT



# Front



Front Fascia Assembly  
FP-17000-DHR



Front Fascia Assembly  
FP-17000-DHR



Cowl Top Assembly  
DHR-COWEL-MOD



Radiator Closeout  
DHR-RADCLOSEOUT



Brake Duct Mounting Bracket  
DHR-BRK-DCT-MNT-BRKT



Brake Duct Inlets  
LCR-DH-BDK

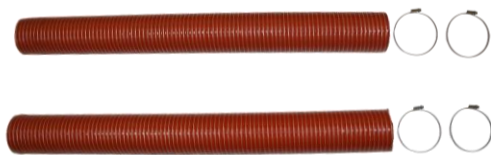

Brake Duct Hose Kit  
LCR-DH-BHK

# Trunk / Rear



Trunk Latch  
WMOD-7643282-BB



Rear Fascia  
FP-17500-DHR



Rear Closeout  
DHR-REARCLOSEOUT-AS



Wing Wicker  
DHR-WING-EXTEN

# Driver Door



Door Foam – LH  
DHR-IMPAXX-LHFOAM



Inner Door Panel – LH  
DHR-INNR-DOOR-PNL



Door Latch Assembly – LH  
DHR-DOORLTCHCABL

# Engine



Sealed Engine – View 1  
FP-6007-DHR



Sealed Engine – View 2  
FP-6007-DHR



Sealed Engine – View 3  
FP-6007-DHR



Sealed Engine – View 4  
FP-6007-DHR

# Engine



Oil Cooler  
SET50-960-7612



Oil Cooler Adapter  
M22AN12-SE



Oil Cooler Lines  
DHR-OIL-CLR-LINES



Oil Cooler Fitting Adapter Kit  
LCR-OCA-12



Catch Can Kit  
DHR-CATCHCAN



Catch Can to Oil Pan Drain Back Hose  
CATCH-CAN-DRAINBACK-HOSE



Heater Hose  
WR-18K580-MOD

# Exhaust



Headers  
FP-9430-DHR



X-Pipe  
FP-5200-DHR



LH Collector Pipe  
FP-5200-DHR



RH Collector Pipe  
FP-5200-DHR



LH Tail Pipe  
FP-5200-DHR



RH Tail Pipe  
FP-5200-DHR

# Fuel



Fuel Cell Spacer  
DHR-FUEL-SPACER



Fuel Cell Lid  
DHR-FUEL-SPACER



Fuel Cell Bladder Assembly  
LCR-DH-FUELCELL



Plate (Fuel Pump Block Off)  
DHR-FUELPMPBLKOFF

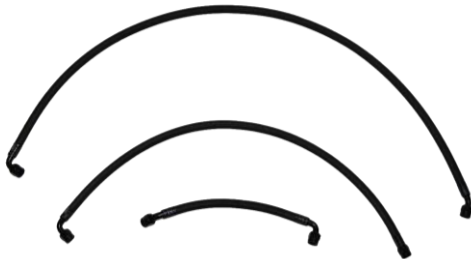

Fuel Lines and Fittings  
DHR-FUEL-LINES



Fuel Line Fitting  
GEN-GA3186

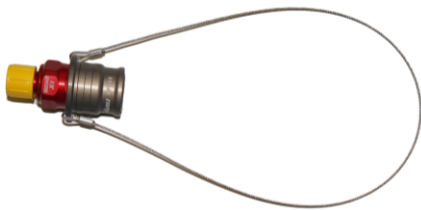

Ball Locking Break Socket (Red)  
STA-SPT08.3655/L/JKV



Ball Locking Break Plug (Red)  
STA-SPT08.7655/L/JKV

# Frame / Mounting



Front Subframe (K Member)  
WMOD-5C145-A



Rear Subframe  
DHR-SUBFRAME-MOD



# Suspension



Bearing Kit for Control Arms - Front / Rear  
SBK-60-1000



Bearing Kit for Control Arms - Front / Rear  
SBK-60-1000



Arm LH - Lower Front Assembly  
DHR-FCNTRLBRNG-MOD



Arm RH - Lower Front Assembly  
DHR-FCNTRLBRNG-MOD



Adjustable Link (Front Anti Roll Bar)  
DHR-FRTSWYBRLINK-AS



Front Brake Line Bracket  
S650-DHR-RH-FRT-BRAKE-LINE-BRKT



Wheel Stud & Nut Kit - Front / Rear  
M-1107-E

# Suspension



Knuckle / Bearing Assembly LH  
CM-5B759-S650



Knuckle / Bearing Assembly RH  
CM-5B758-S650



Upper Shock Mount – RH / LH  
DHR-RUPRSHKMOUNT



Lower Shock Mount, Top  
LCR-LSBRKT-DH



Lower Shock Mount Assembly, Bottom  
DHR-RLOWERSHKMNT



Rear Adjustable Toe Link Assembly  
DHR-TOE-LINK-ASSY



Adjustable Rear Drop Link w/ Hardware  
LCR-DH-RSBL

# Suspension



Rear Lower Control Arm LH  
DHR-RCNTRLBRNG-MOD



Rear Lower Control Arm RH  
DHR-RCNTRLBRNG-MOD

# Dampers



Spring, Rear  
18C1000



Spring, Front  
187B0700



Spring Bearing Kit, Rear (2")  
GEN-GC1017



Spring Bearing Kit, Front (2.5")  
GEN-GC1015



Front Damper - LH  
FP-18000-DHR



Front Damper - RH  
FP-18000-DHR



Rear Damper - LH/RH  
FP-18000-DHR



Front Camber Adjuster Plates  
FP-18000-DHR

# Brakes - ABS



Dark Horse R ABS M5 Clubsport Kit  
FP-2353-DHR



MSA Box, Signal Converter  
F02U.V00.327-03



ABS Sensor - Front LH  
JR3C-2C204-B1B



ABS Sensor - Front RH  
JR3C-2C205-B1B



Front ABS Wire Hanger LH / RH  
S650-DHR-FRT-ABS-WIRE-BKRT-ASSY



ABS Wire Bracket LH / RH  
PR3C-2C224-AA / PR3C-2C224-BA



ABS Bracket  
DHR-ABSBKRT-AS

# Brakes - Front

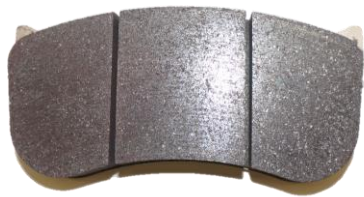

Brake Pad  
P1309.17.F01



Brake Pad  
P1309.17.F01



Front Caliper Bracket w/ Hardware  
20B71805



Front Caliper - LH / RH  
XB8GK51 / XB8GK52



Front Brake Backing Plate LH / RH Kit  
DHR-BRAKE-BKNG-PLT-L / R



Brake Disc Assembly  
759B97936

# Brakes - Lines



Master Cylinder to ABS – Front  
DHR-SSBRAKELINEKIT



Master Cylinder to ABS – Rear  
DHR-SSBRAKELINEKIT

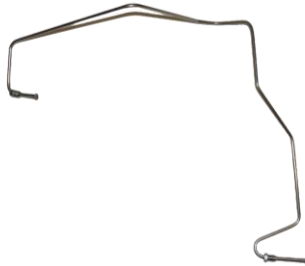

Front Brake Line – LH  
DHR-SSBRAKELINEKIT



Front Brake Line – RH  
DHR-SSBRAKELINEKIT



Rear Brake Lines – LH / RH  
DHR-SSBRAKELINEKIT



Flexible Brake Line Kit  
DHR-FLEX-BRK-LINES

# Driveline

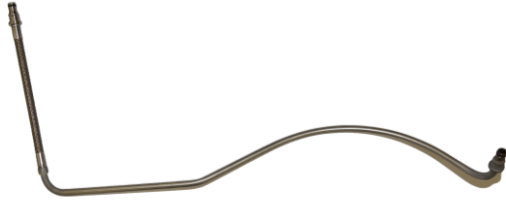

SS Clutch Line  
S650-DHR-CLUTCH-LINE



Clutch Master Feed Kit  
LCR-CMFK-DH



Transmission / Differential Vent  
MR3Z-7A246-B



Half Shaft  
DHR-HALFSHAFT-MOD



Shifter Kit  
LCR-7210-A

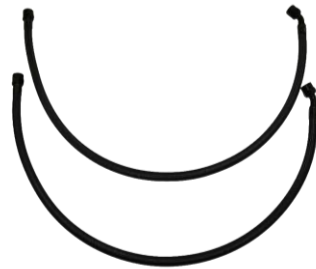

Transmission Cooler Lines  
DHR-TRANS-CLR-LINES



# Driveline



Drive Shaft Loop Kit – Front  
CM-5478-MGTF



Drive Shaft Loop Kit - Rear  
CM-5478-350S-R



Differential Pump  
GEN\_GC1111



Bracket (Diff Pump to Body)  
DHR-DIFFPMPBRKT-AS



Differential Cooler and Fan Unit  
SETFP920M22I



Differential Cooler and Fan Unit Bracket  
DHR-DIFF-CLR-BRKT



Filter Screen for Differential Cooler  
SET11-UF08



Differential Cooler Lines  
DHR-DIFF-CLR-LINES

# Steering



Steering Wheel  
M-3600-RA



Multifunction Switch  
DHR-CLMNSWTCB-MOD



Steering Hub  
01502067CA



Quick Release w/ Hardware  
015R98TU



Steering Wheel Hook  
JOES-10704-B

# Wheels & Tires



Tires – Slick  
44542



Tires – Wet  
89892



Wheel  
CM-1007-R1MB19X105 / CM-1007-R1MB19X11

# Data



Data System, MC187  
M C187 Dark Horse R



Data System GPS Antenna  
M GPS-L10



Bracket (Mount Screen to Clock Spring)  
DHR-MOTECBRKT



ProCal 4  
M-12655-F



Oil / Trans Temperature Sensor  
M 25-2197D



Optional Shift Light Module  
18120

# Electrical



Battery Harness, Modified  
PR3T-14A005-ZEMOD



Battery to Breaker Cable  
FP-14B060-AA



Breaker to Relay Cable  
FP-14B060-BA



PDB Harness, Modified  
PR3T-14290-HEMOD



Main Breaker  
353250



Front Loom  
FP-14290-AA



Relay  
TE 29-311-11



Cockpit Loom  
FP-14A005-AA

# Electrical



IP (Dash) Harness, Modified  
PR3T-14401-EEMOD



Body Harness, Modification  
PR3T-14A005-ZEMOD



Switch Panel / Harness  
DHR-CENTERSTACK / FP-14401-BA



Master Power Panel  
DHR-MSTR-PWR-PNL



PTT Jumper Harness  
FP-14401-AA



Steering Wheel Switch Plate / Harness  
FP-14A664-AA / DHR-STRNGWHLSWTCH



Door Harness - RH  
PR3T-14630-HFMOD



Door Harness - LH  
PR3T-14631-KFMOD

# Electrical



Diff Pump Jumper Harness  
FP-14A411-A



Fuel Pump Jumper Harness  
FP-2B572-A



Can Bridge Module  
M-14660-2FD



HS2-CAN Jumper  
FP-14401-CA



Diff Temp / Rear Chassis Harness  
PR3T-2B572-FEMOD



CAN Jumper Harness (IP)  
FP-14401-DA



CAN Jumper Harness (Underhood)  
FP-14290-BA

# Safety Equipment



Driver Safety Harness  
SAB-CFCI22100056



Safety Seat  
071.38.0630-01



Safety Seat Bracket  
7206293NA



Window Net Mounting Kit  
DHR-NETHRDWR

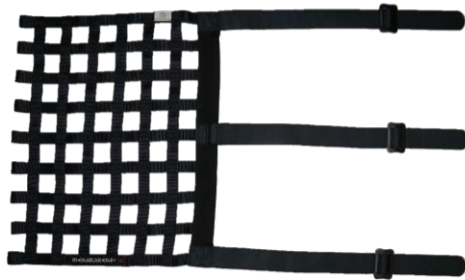

Driver Window Net  
LCR-DH-LHWN

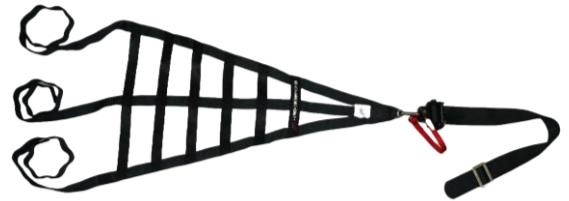

Helmet Support Net, Right Side  
SFC-8011-K-FIA

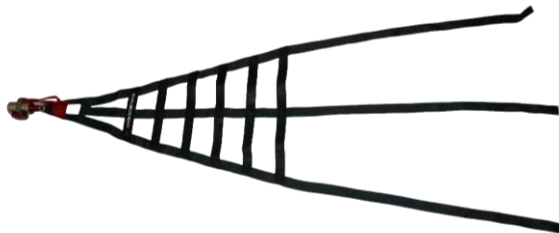

Helmet Support Net, Left Side  
SFC-8111-K-L-FIA



Roll Bar Padding  
BSCI-78001



# Safety Equipment



Fire Bottle / Mount  
014772MSL

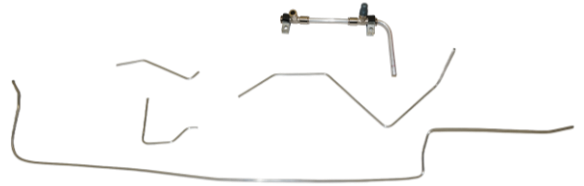

Fire Suppression Lines  
014772MSL



Fire Suppression System Fittings / Nozzles  
014772MSL



Fire Suppression System Pull Cable  
014772MSL

# Recommended Fluids



Gear Lubricant, Ford Motorcraft 75W-85  
XY-75W85-QL



Motor Oil, Ford Motorcraft 5W-50  
XO-5W50-QGT



Coolant (Motorcraft Gold) (50/50)  
VC-13-G



Trans Fluid (Motorcraft Mercon LV)  
XT-10-QLVC



Brake Fluid, Brembo HTC64  
04816420

# Appendix

# Driver Safety Harness System

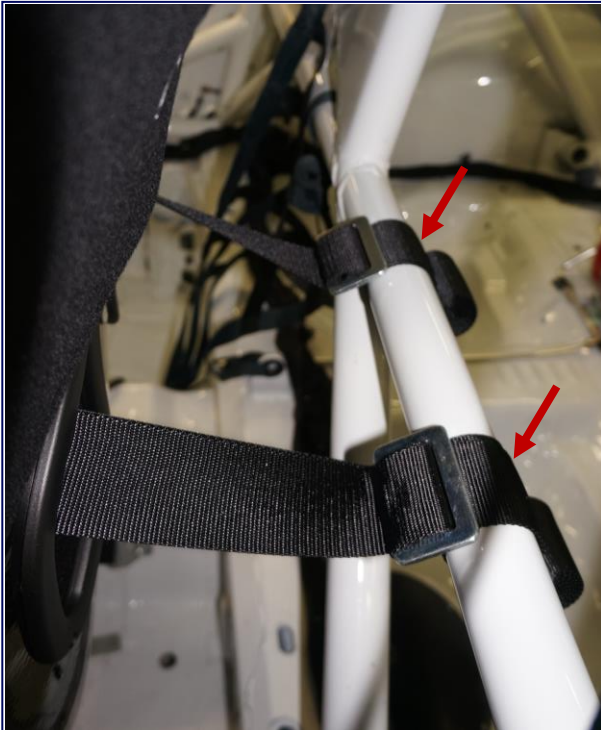

Harness Mounting Points  
Roll Cage Behind Driver's Seat

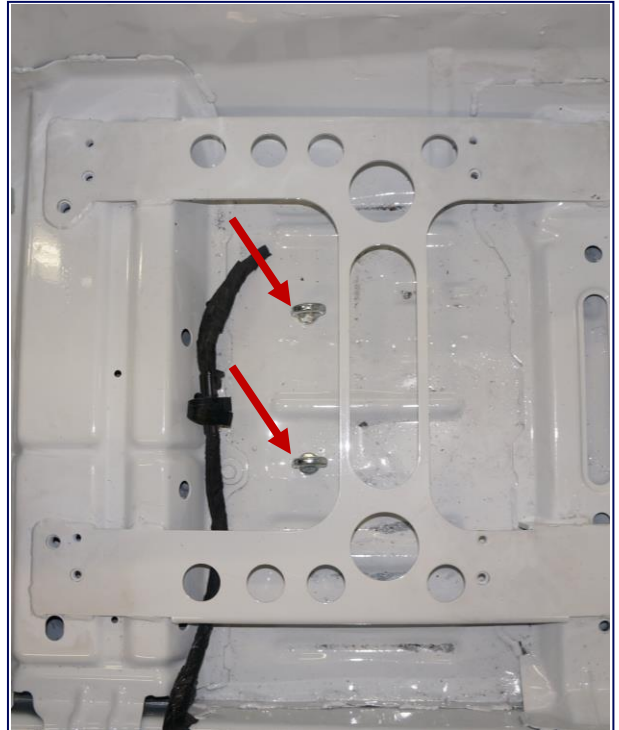

Harness Mounting Points  
Driver's Side Floor



Harness Mounting Point  
Driver's Side Rear

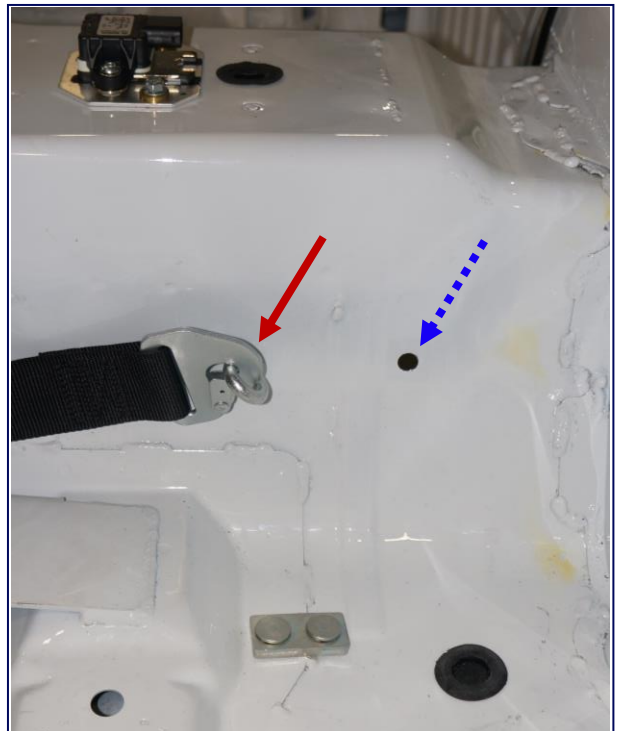

Standard Harness Mount Location (Red)  
Optional Harness Mount Location for use with Inboard Seat  
Mount Location (Blue Dashed)  
Left Side of Drive Shaft Tunnel

# Seat Mounting Points

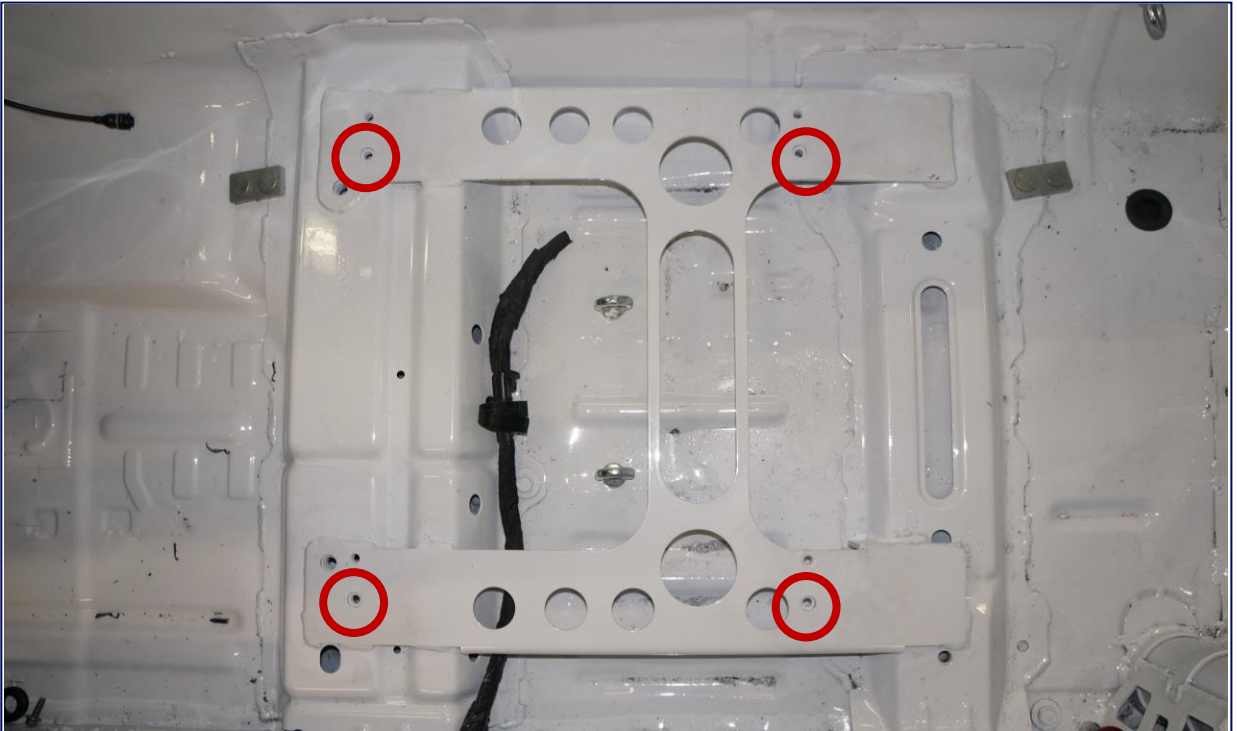

Standard Seat Bracket Mounting Points

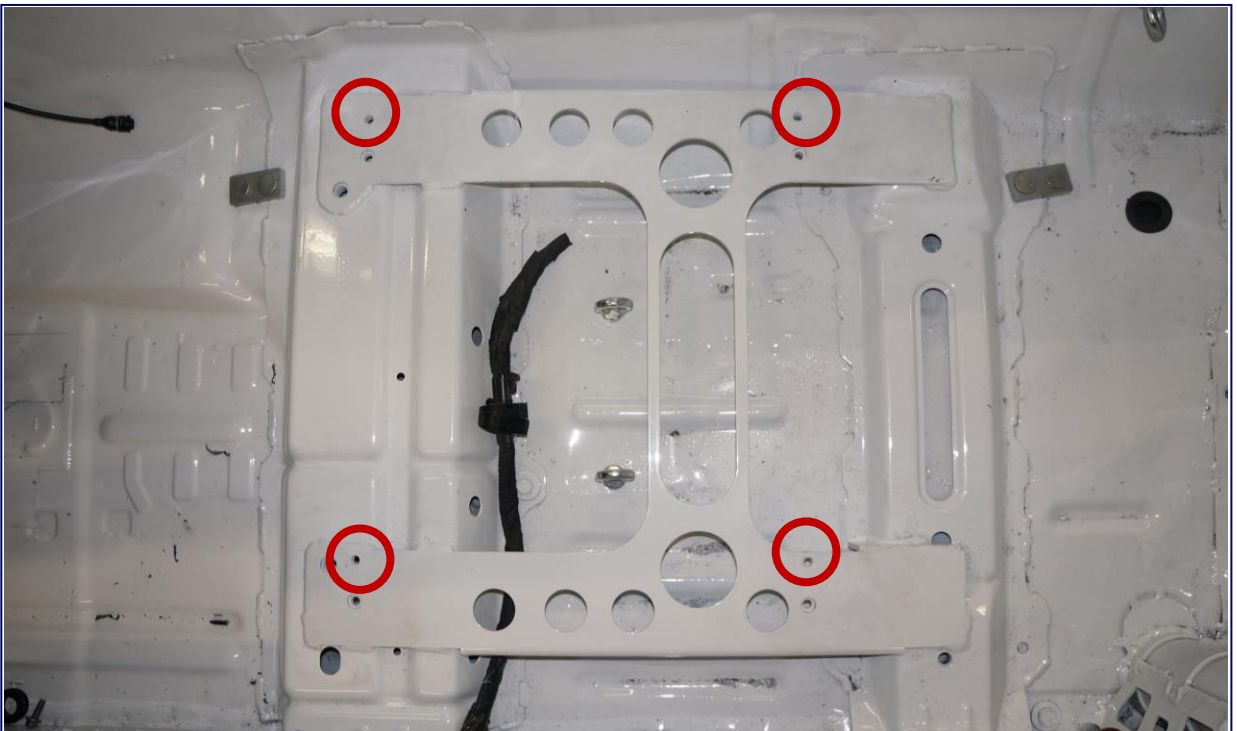

Inboard Seat Bracket Mounting Points

## Optional Seat / Mount



Safety Seat  
P/N: 071.28.UU11-01



Flexible Sidemount  
P/N: 7221002NA

# Window Nets



RH Helmet Support Net (Ratchet Release)  
Mounting Points

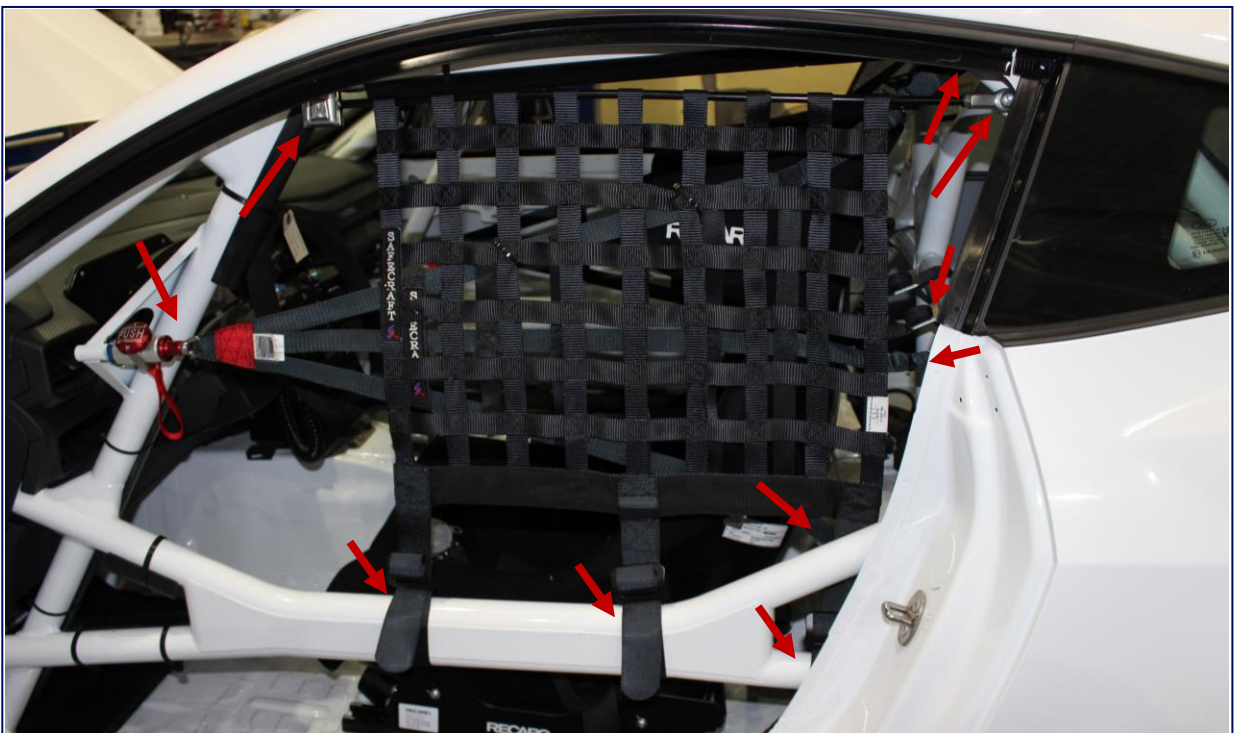

LH Driver Window Net + Helmet Support Net (Quick Release)  
Mounting Points

# Window Nets



Driver Helmet Support Net Mounting Points

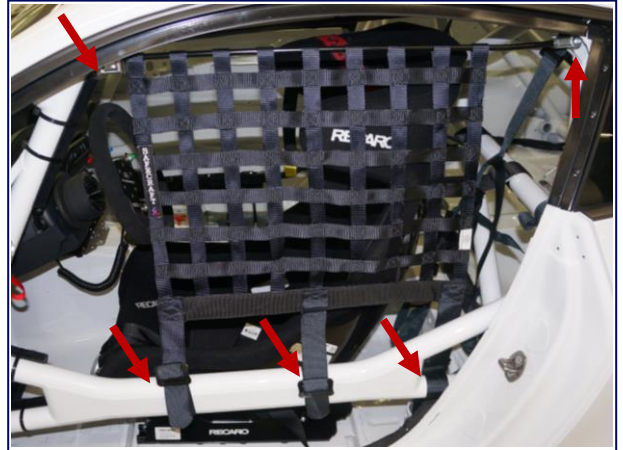

Driver Window Net Mounting Points

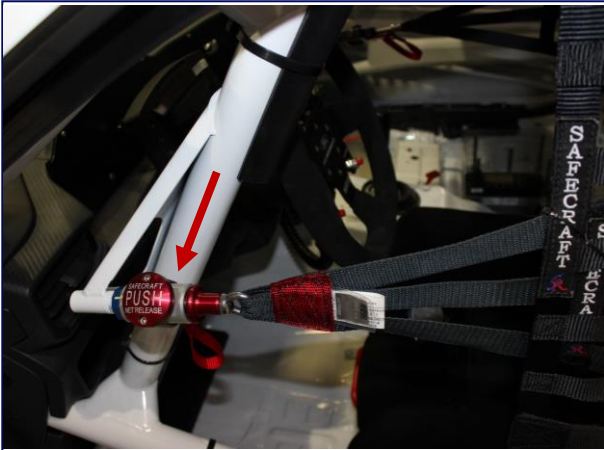

Driver Helmet Support Net Quick Release

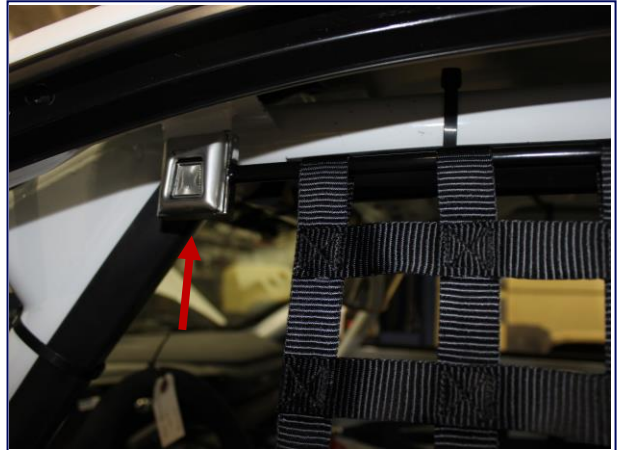

Driver Window Net Rod Release



Driver Helmet Support Net Mounting Points



Driver Window Net Rod Mounting Point



# Roll Bar Padding



Roll Bar Padding Locations



Roll Bar Padding Locations

# Master Power Electrical Switch



Interior Master Power Electrical Switch



Exterior Master Power Electrical Switch  
Exterior Driver Side

# Fire Suppression System

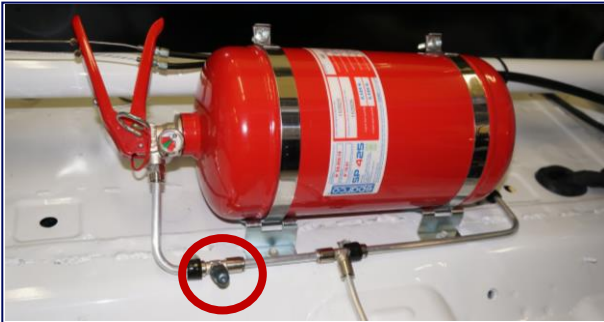

Fire Bottle Mount + Nozzle



Driver's Feet Nozzle

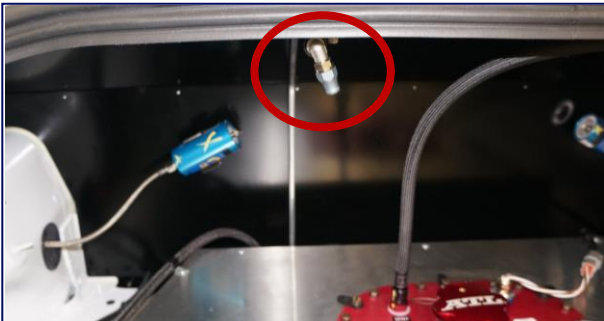

Fuel Cell Nozzle



Engine Bay Nozzle 1  
Driver Side



Engine Bay Nozzle 2  
Passenger Side

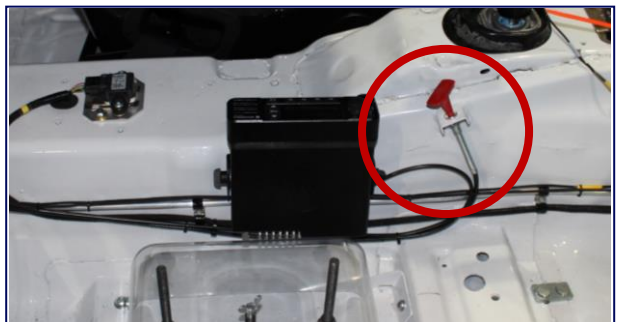

Interior Cable Pull  
Right Side of Drive Shaft Tunnel



Exterior Cable Pull  
Exterior Driver Side

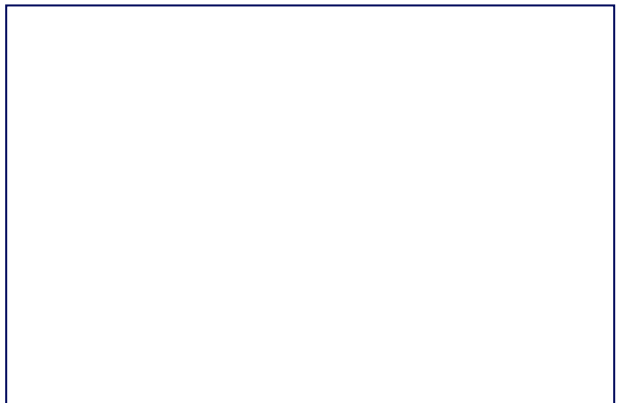

# Ballast



Ballast Assembly Location  
Passenger Side Floor

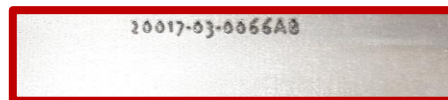
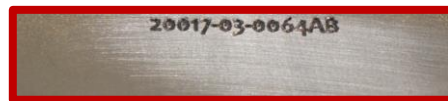

Ballast Plates (Not Included)  
FIA Approved Ballast Plates are Allowed

# Air Jack System



Air Jack Bezel  
13052-09-1110 (Qty: 1)



Krontec Connecting Valve  
KR0.LL.16 or KR0.LL.16PLUS (Qty: 1)



Krontec Air Lift  
Std. 60mm M60 X 1.5 HUB 230 mm  
KR0.LL.24 (Qty: 4)

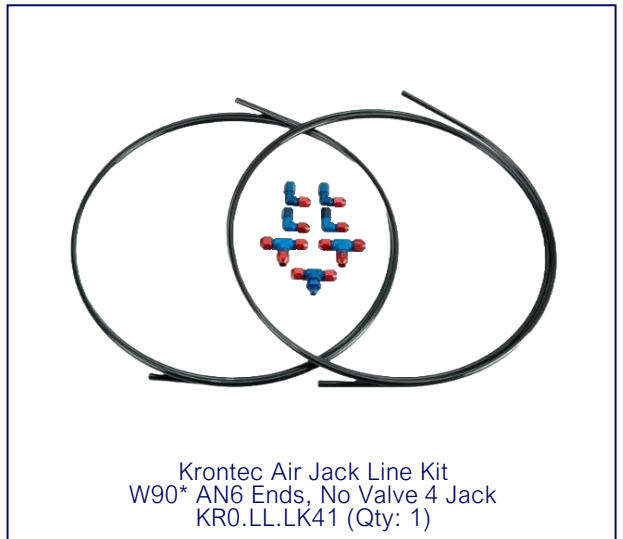

Krontec Air Jack Line Kit  
W90\* AN6 Ends, No Valve 4 Jack  
KR0.LL.LK41 (Qty: 1)

Use routing locations as shown in this document.  
Connection valve location is open.

# Air Jack System

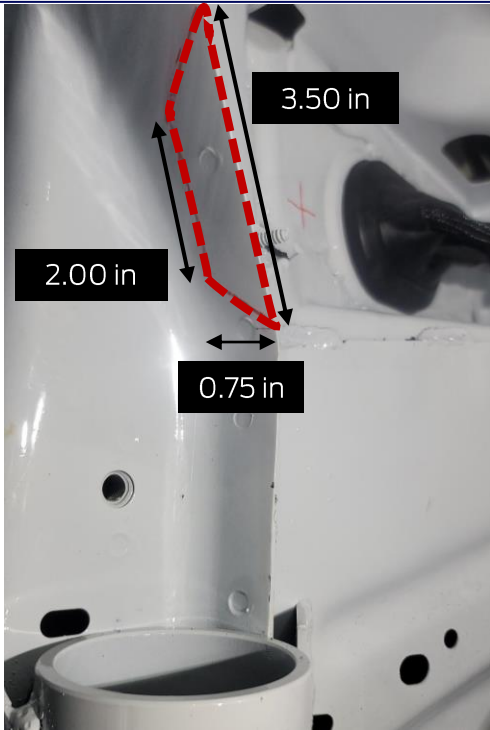

Front Seam Modification  
Passenger Side Shown, Driver Side Opposite

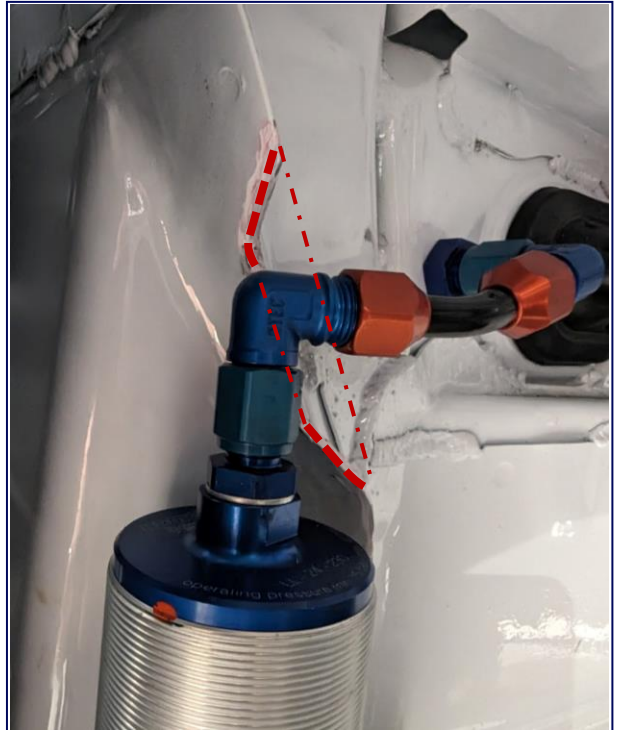

Front Seam Modification  
Passenger Side Shown, Driver Side Opposite



Front Air Jack / Bulkhead Connection  
Passenger Side



Front Air Jack / Bulkhead Connection  
Driver Side

# Air Jack System

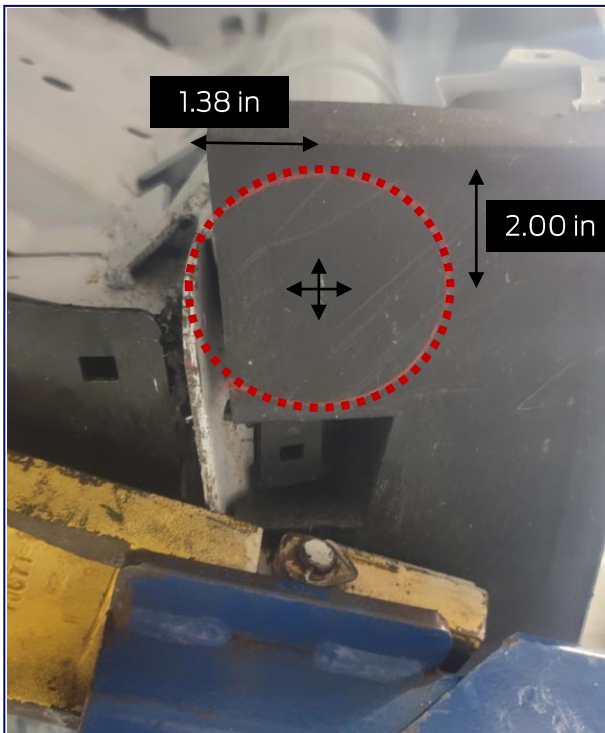

Front Air Jack Side Skirt Modification  
Driver Side Shown / Passenger Side Opposite



Front Air Jack Side Skirt Modification  
Driver Side Shown / Passenger Side Opposite

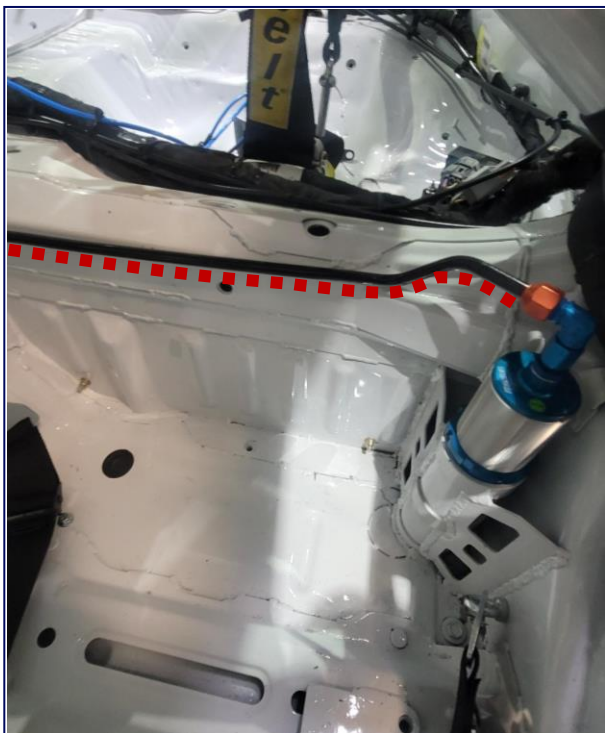

Rear Air Jack  
Driver Side

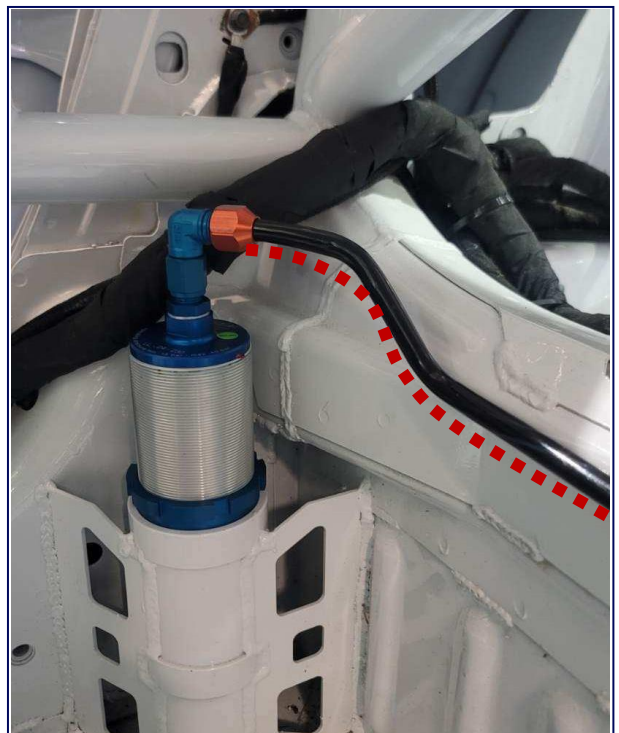

Rear Air Jack  
Passenger Side

# Air Jack System

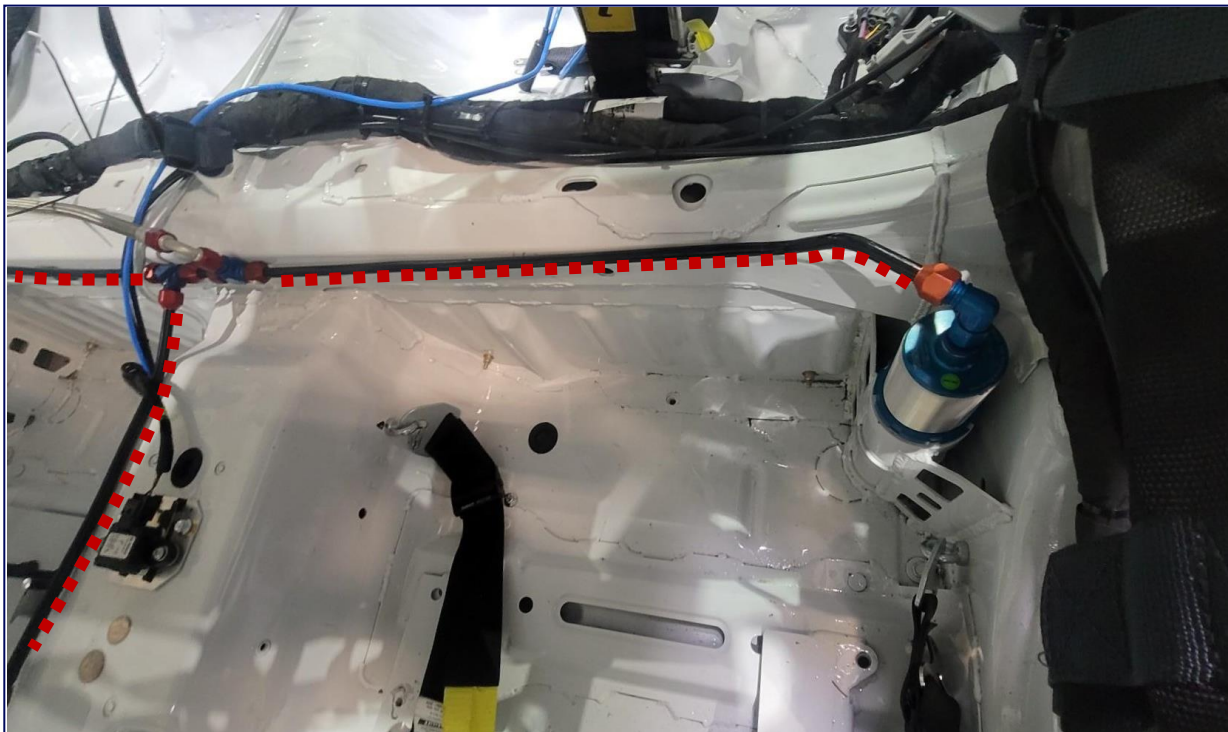

Rear Air Jack / Routing  
Driver Side

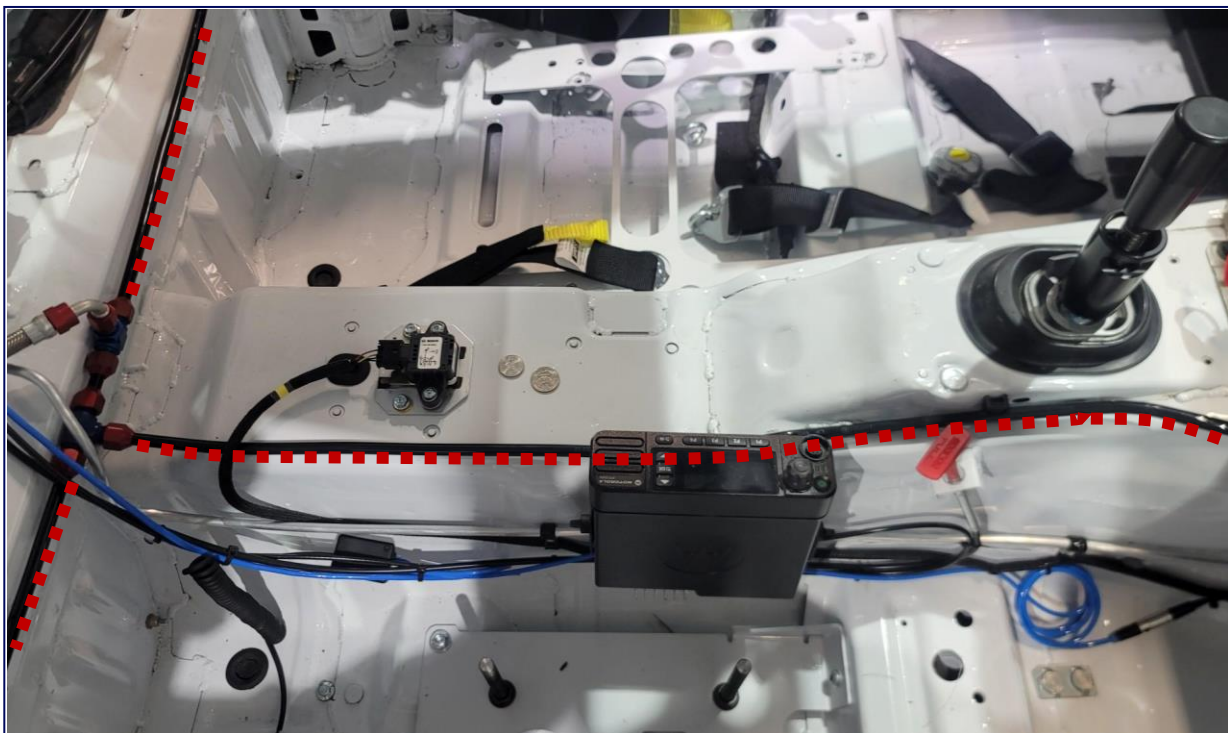

Air Line Routing  
Passenger Side of Transmission Tunnel



# Air Jack System

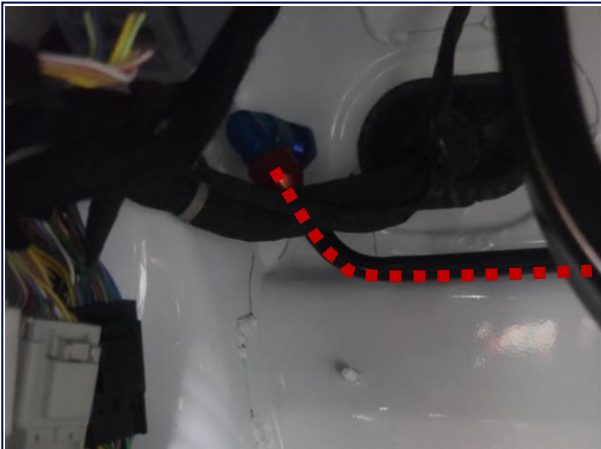

Front Air Jack  
Driver Side



Front Air Jack Line Routing  
Driver Side

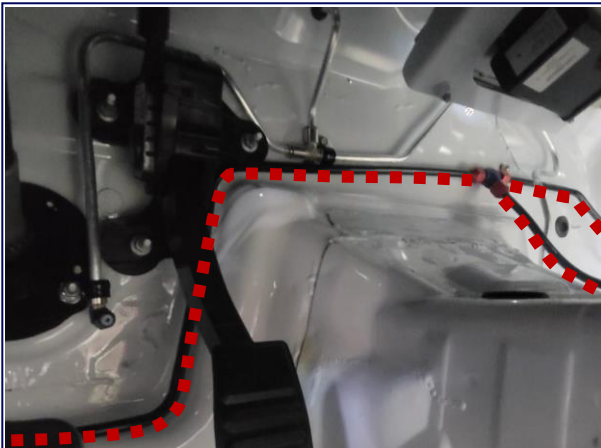

Front Air Jack Line Routing  
Driver Side

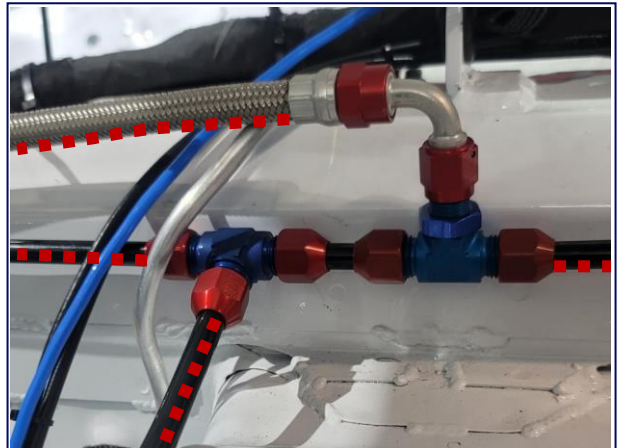

Airline Union to Rear Air Jacks / Air Feed  
Line Junction

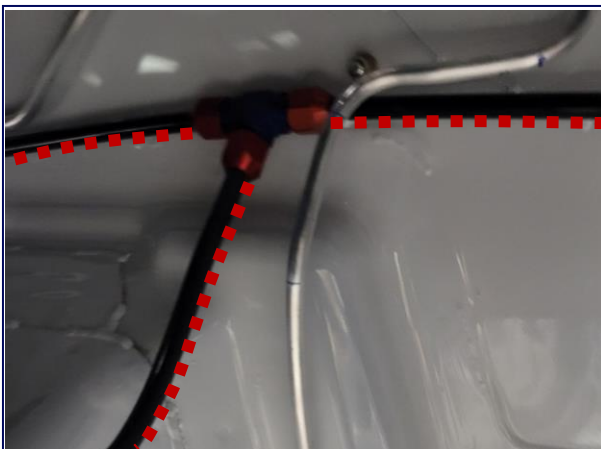

Front Air Jack Union  
Union of Passenger Side and Side of Transmission Tunnel



Front Air Jack  
Passenger Side

# Optional Front / Rear Springs

## Front Hyperco Springs

SKU	Inside Diameter [in]	Free Length [in]	Rate [lbs/in]	Deflection [in]	Load [lb]	Outside Diameter [in]	Solid Height [in]	Color
187B0500	2.5	7	500	4.403	2202	3.661	2.597	Blue
187B0600	2.5	7	600	4.260	2556	3.708	2.740	Blue
187B0650	2.5	7	650	4.184	2719	3.708	2.816	Blue
187B0700	2.5	7	700	4.103	2872	3.687	2.897	Blue
187B0750	2.5	7	750	4.036	3027	3.690	2.964	Blue
187B0800	2.5	7	800	3.991	3192	3.729	3.009	Blue
187B0850	2.5	7	850	3.974	3378	3.864	3.026	Blue
187B0900	2.5	7	900	3.793	3413	3.834	3.207	Blue



## Rear Hyperco Springs

SKU	Inside Diameter [in]	Free Length [in]	Rate [lbs/in]	Deflection [in]	Load [lb]	Outside Diameter [in]	Solid Height [in]	Color
186C0700	2	6	700	3.317	2322	3.009	2.683	Blue
186C0750	2	6	750	3.078	2308	2.958	2.922	Blue
186C0800	2	6	800	3.293	2634	3.203	2.707	Blue
186C0850	2	6	850	3.199	2720	3.110	2.801	Blue
186C0900	2	6	900	3.146	2831	3.156	2.854	Blue
186C0950	2	6	950	2.901	2756	3.020	3.099	Blue
186C1000	2	6	1000	3.070	3069	3.128	2.930	Blue



# Ride Height Reference Points

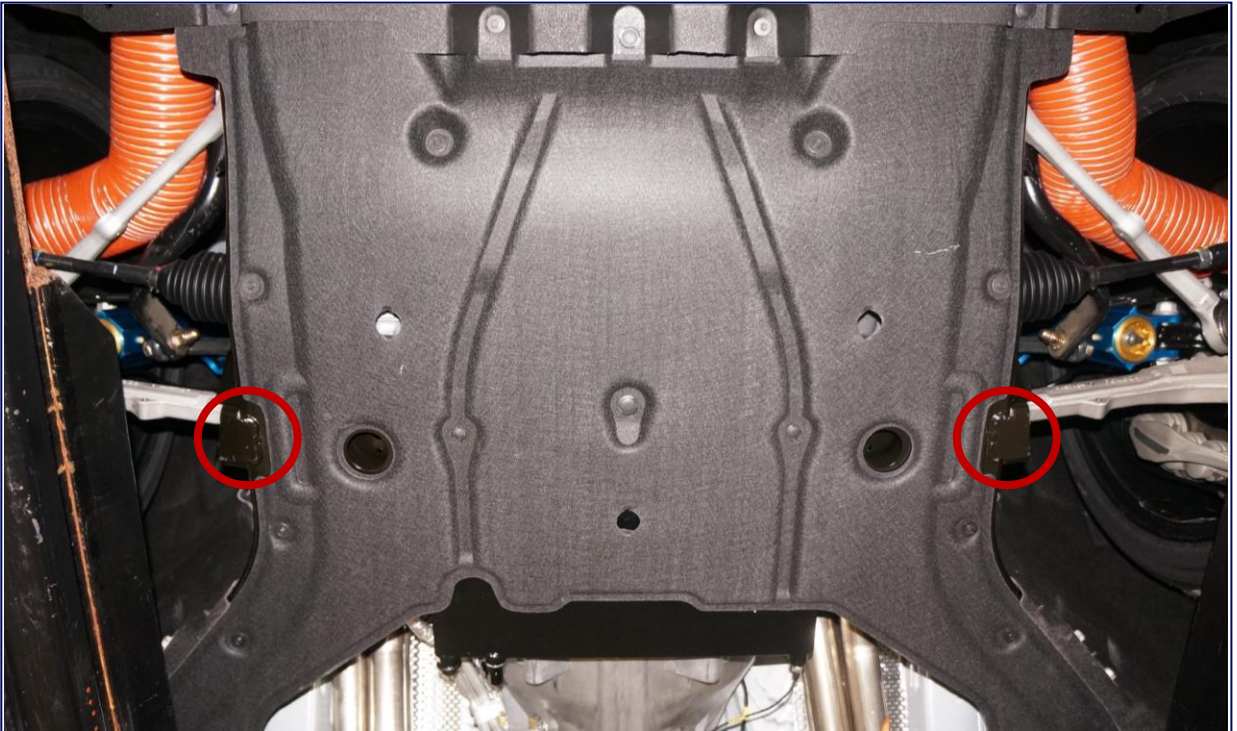

Front Ride Height Reference Points

# Radio



Radio Location  
Right Side of Drive Shaft Tunnel



Radio Mounting Location  
(2) M6 Rivnuts Provided



Radio Antenna Location  
Driver's Side Roof Panel

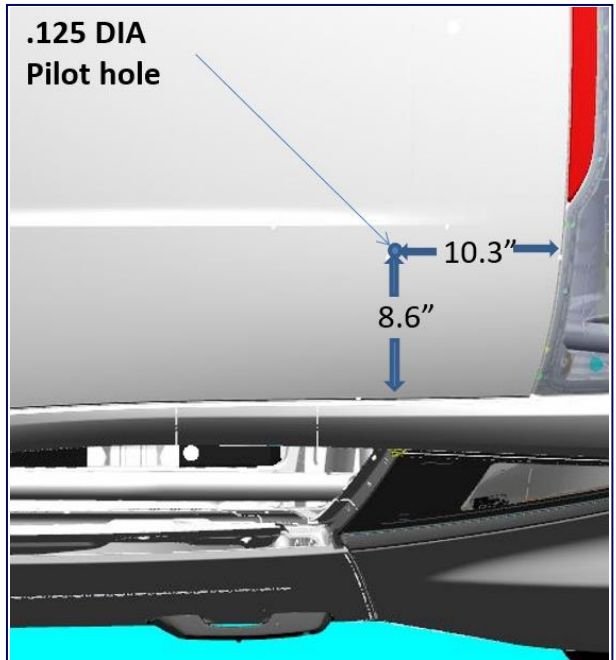

Radio Antenna Location Diagram  
(a 1/8" pilot hole is provided)

# Yellow Flag Warning System



Light Location  
Dash Closeout

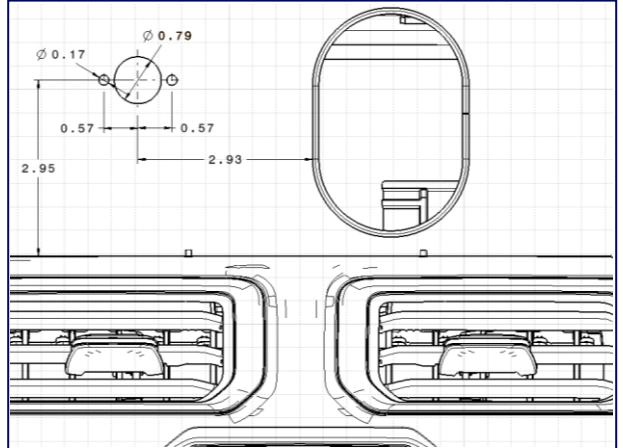

Panel Cut Diagram for Light  
(all dimensions are in inches)



Antenna Location  
Passenger Side Roof

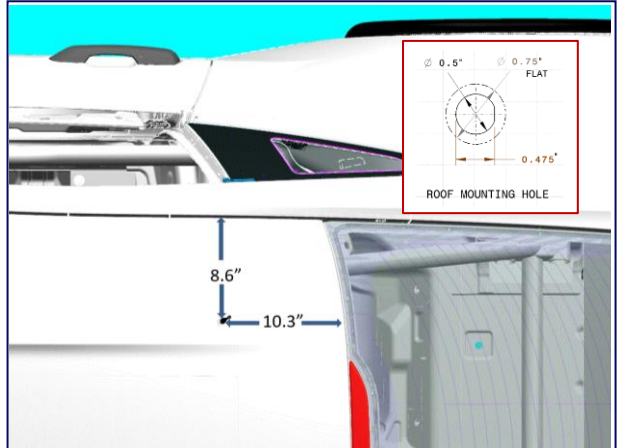

Antenna Location Diagram  
(a 1/8" pilot hole is provided)

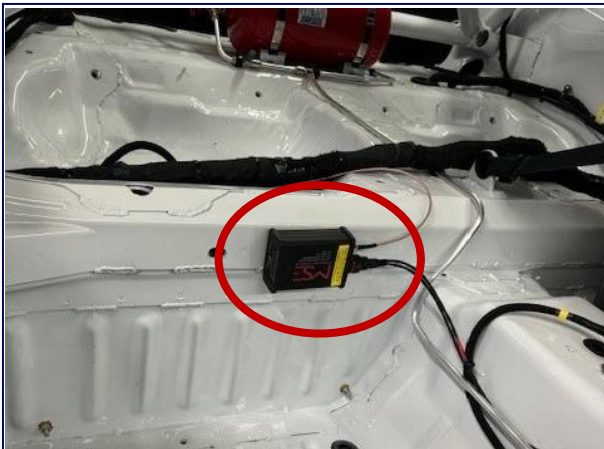

MSE Box Location  
Passenger Side Waterfall

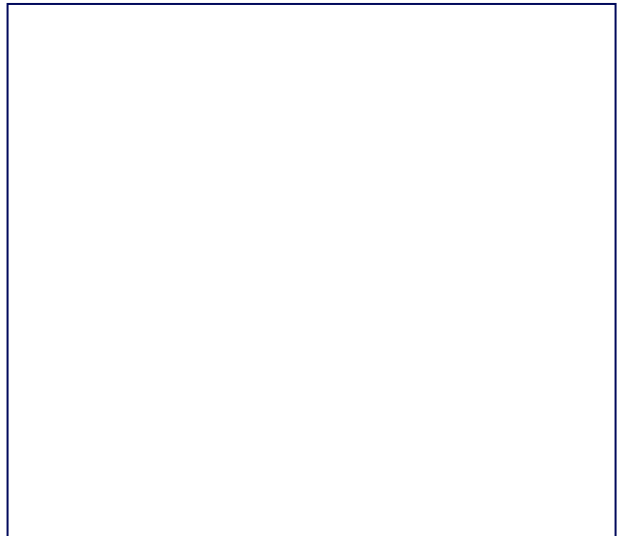

# Transponder



Transponder Location  
Front Passenger Side



Transponder Location

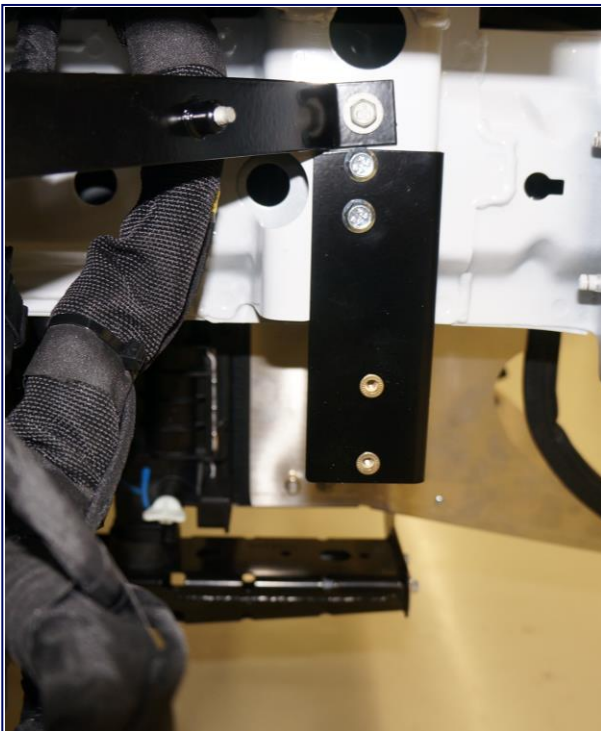

Transponder Bracket Location  
Front Passenger Side

# Incident Data Recorder

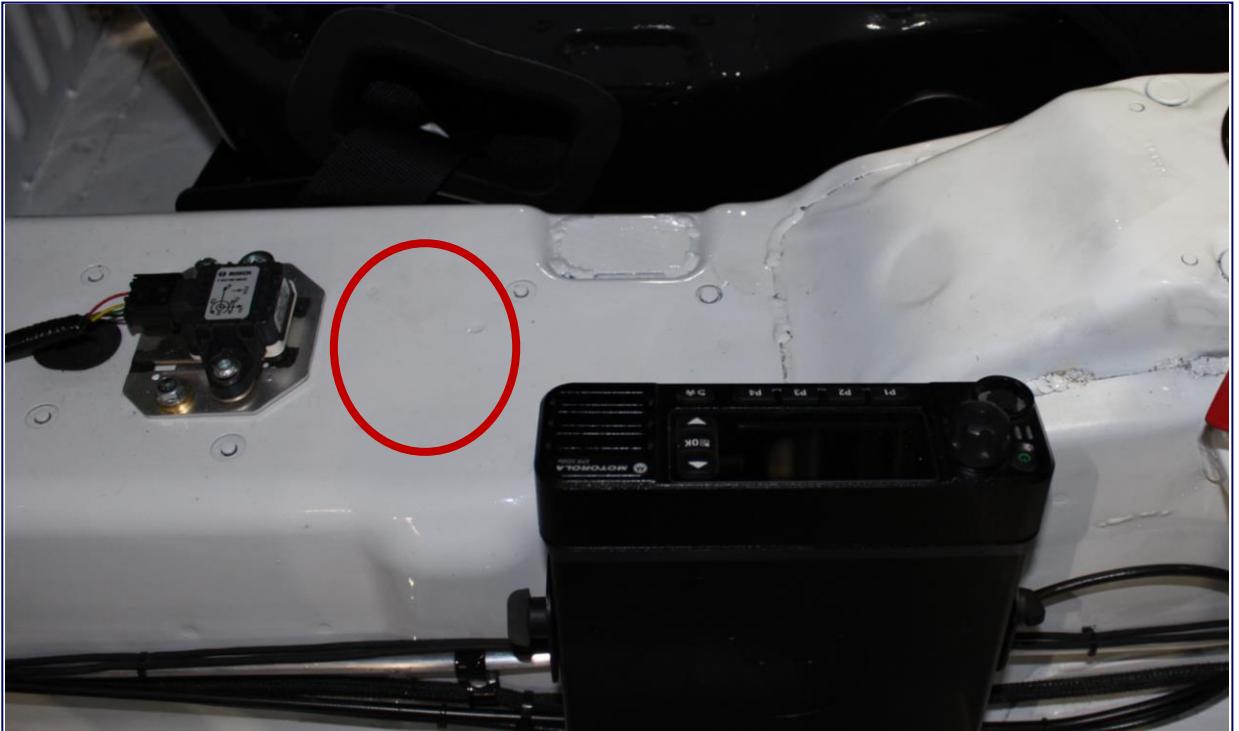

Incident Data Recorder Location  
Top of Trans Tunnel

# Camera System



VBOX Mount Location Option 1  
Passenger Side Roll Cage

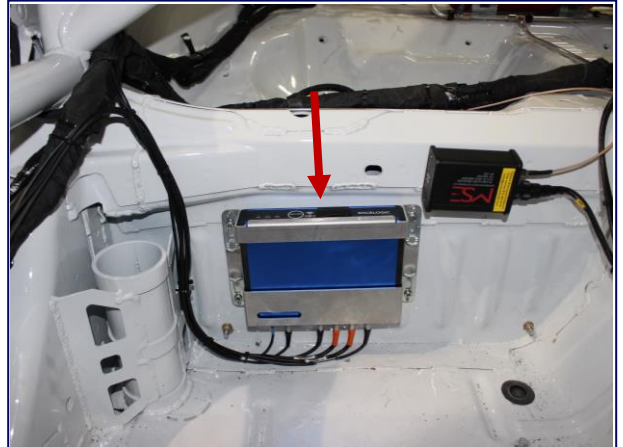

VBOX Mount Location Option 2  
Passenger Side Waterfall

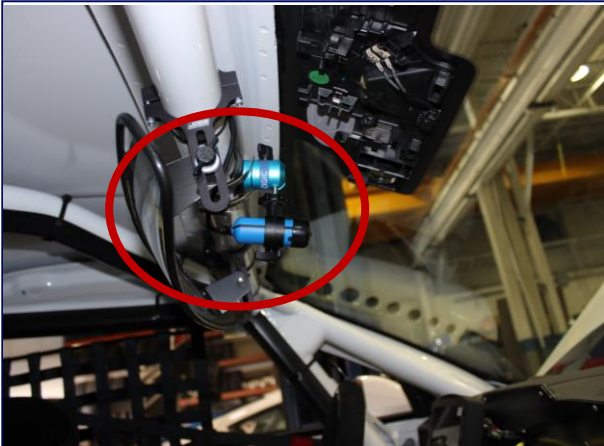

VBOX / GoPro Camera Location 1  
Behind Rear View Mirror



VBOX / GoPro Camera Location 2  
Passenger Side Roll Cage

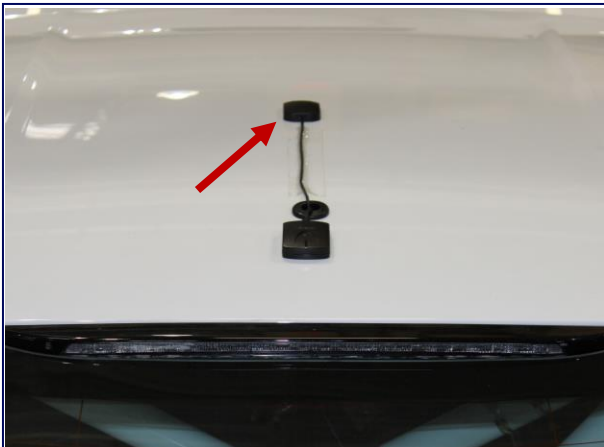

VBOX Antenna Location  
Roof Center

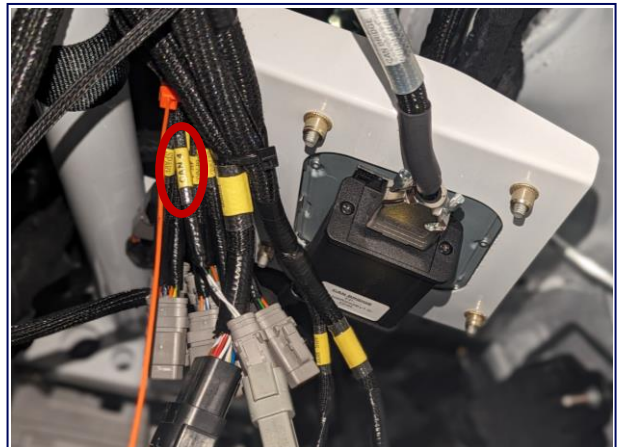

VBOX Wiring Labeled "CAN4"  
Underneath Dash



# Camera System

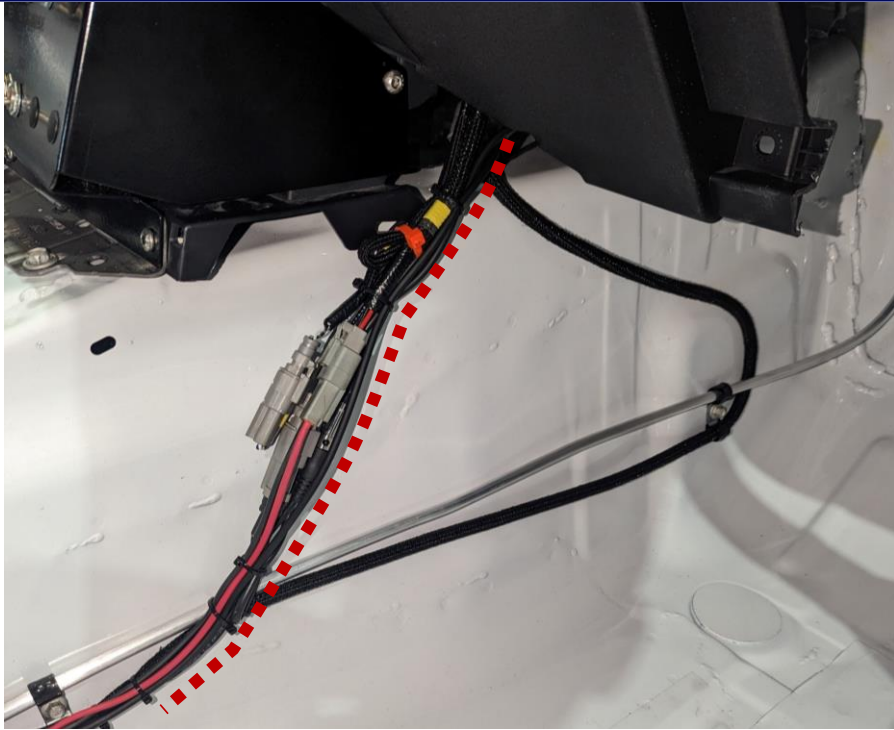

VBOX Harness Routing (Red Dotted Line)

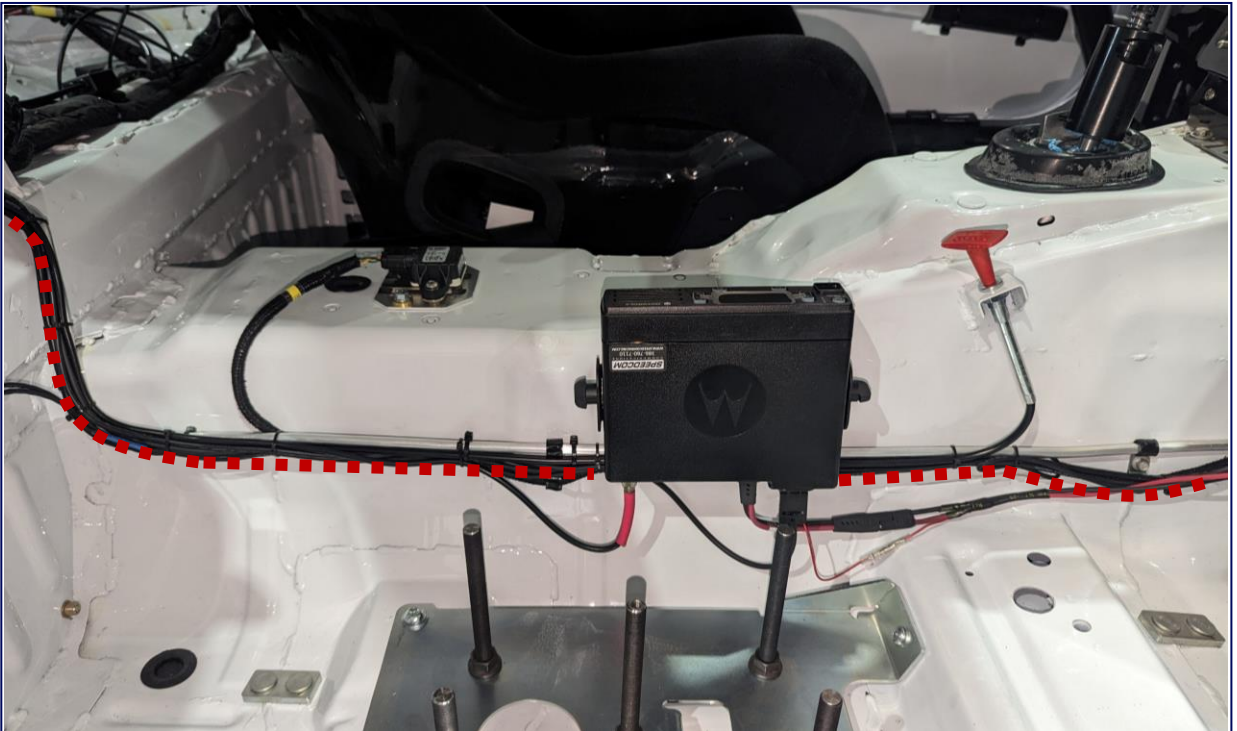

VBOX Harness Routing (Red Dotted Line)

# Engine Seals



Engine Seal 1  
Timing Cover Seal



Engine Seal 1  
Timing Cover Seal



Engine Seal 2  
Valve Cover LH Seal



Engine Seal 2  
Valve Cover LH Seal



Engine Seal 3  
Valve Cover RH Seal



Engine Seal 3  
Valve Cover RH Seal



Engine Seal 4  
Intake Manifold Seal



Engine Seal 4  
Intake Manifold Seal

# Transmission / Rear Axle Seals

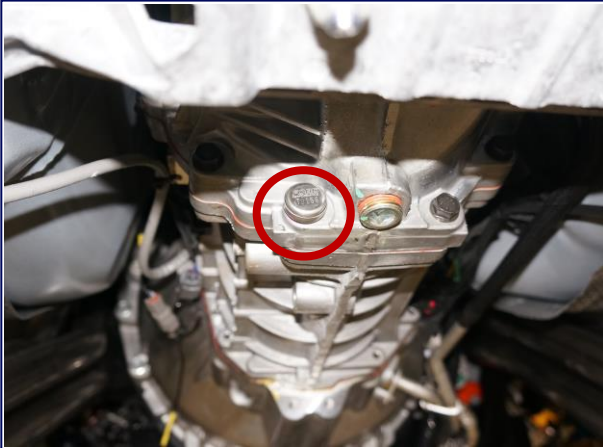

Transmission Seal 1

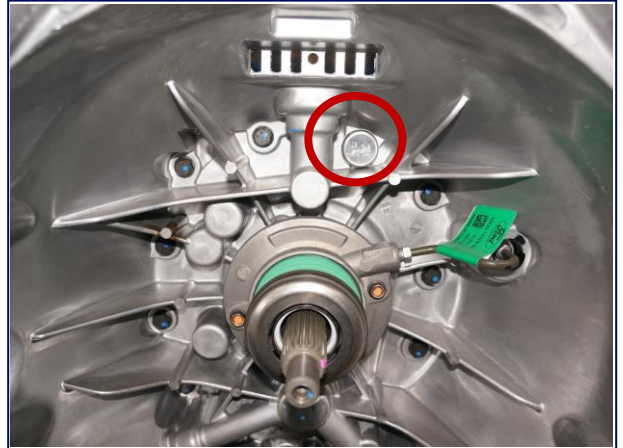

Transmission Seal 2  
Inside Bell Housing



Rear Axle Seal

# Grill Mesh



½" on Center Mesh or 1.3 x 1.3 Mesh Size (0.687" Opening Size) allowed on marked location.  
Must be positively attached using safety wire or zip ties.



1.3 x 1.3 Mesh Size (0.687" Opening Size) allowed on marked locations.  
Must be positively attached using safety wire or zip ties.

# Grill Mesh



Currently Optional Grill Mesh Modification  
Upper and Lower Grill



Currently Optional Grill Mesh Modification  
Upper and Lower Grill

# Driver Cooling System



Driver Cooling System Location  
Passenger Side Footwell

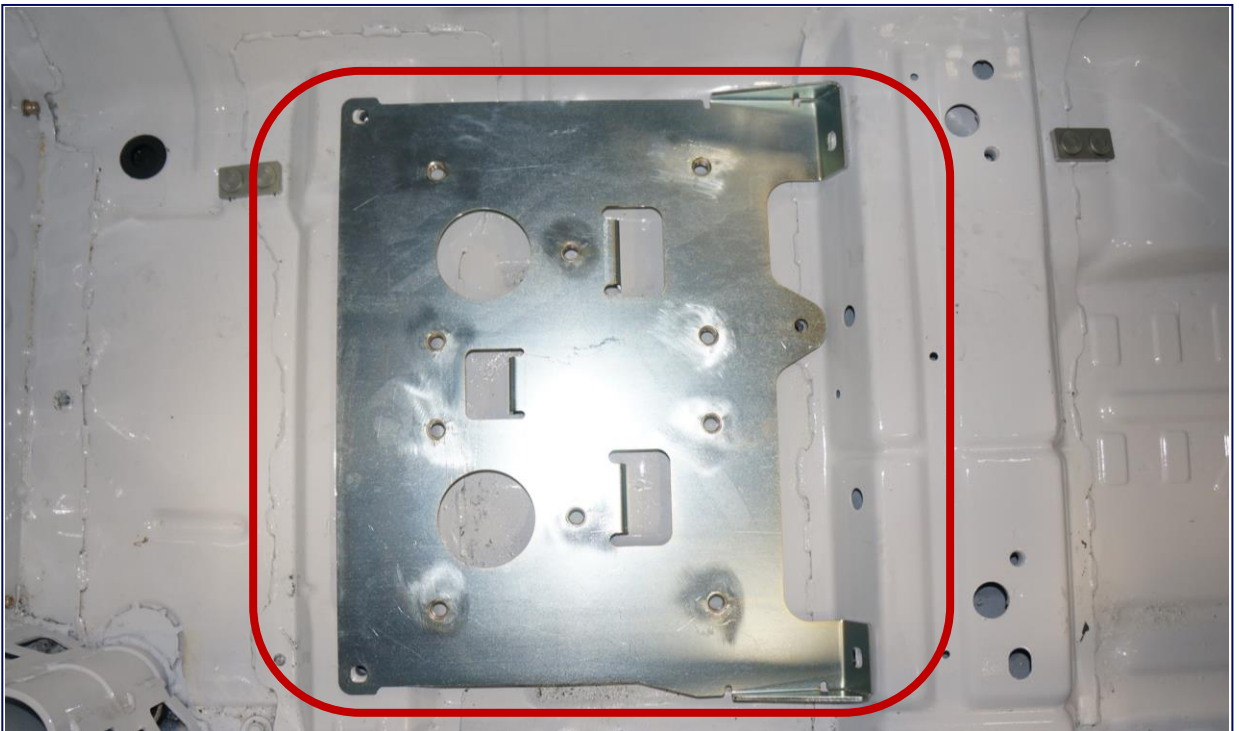

Alternate Driver Cooling System Mount Location\*  
Passenger Side

\*Only if not using Ballast Plates, the Ballast Plate location may be used to mount accessories.

# Driver Cooling System



Optional Driver Cooling System Mount\*  
13052-09-1158  
Passenger Side Rear Seat  
\*Mount will be zinc-plated



Optional Driver Cooling System Mount\*  
13052-09-1158  
Passenger Side Rear Seat  
\*Mount will be zinc-plated

# Engine Cooling Modifications



Radiator Closeout after Duct Removal  
Required



Fan Shroud Modification  
Required



# NEW Radiator



Radiator, Front Side  
CR-CC-Y1100-002



Radiator, Rear Side  
CR-CC-Y1100-002



Lower Radiator Aluminum Hose  
FP-8286-A



Tie Wrap



Lower Radiator Soft Hose, 5.5 in  
Inlet to Thermostat Housing  
FP-8286-B



Lower Radiator Soft Hose, 4.5 in  
Radiator Side  
FP-8286-C

# Under Hood / Trunk



Under Hood View

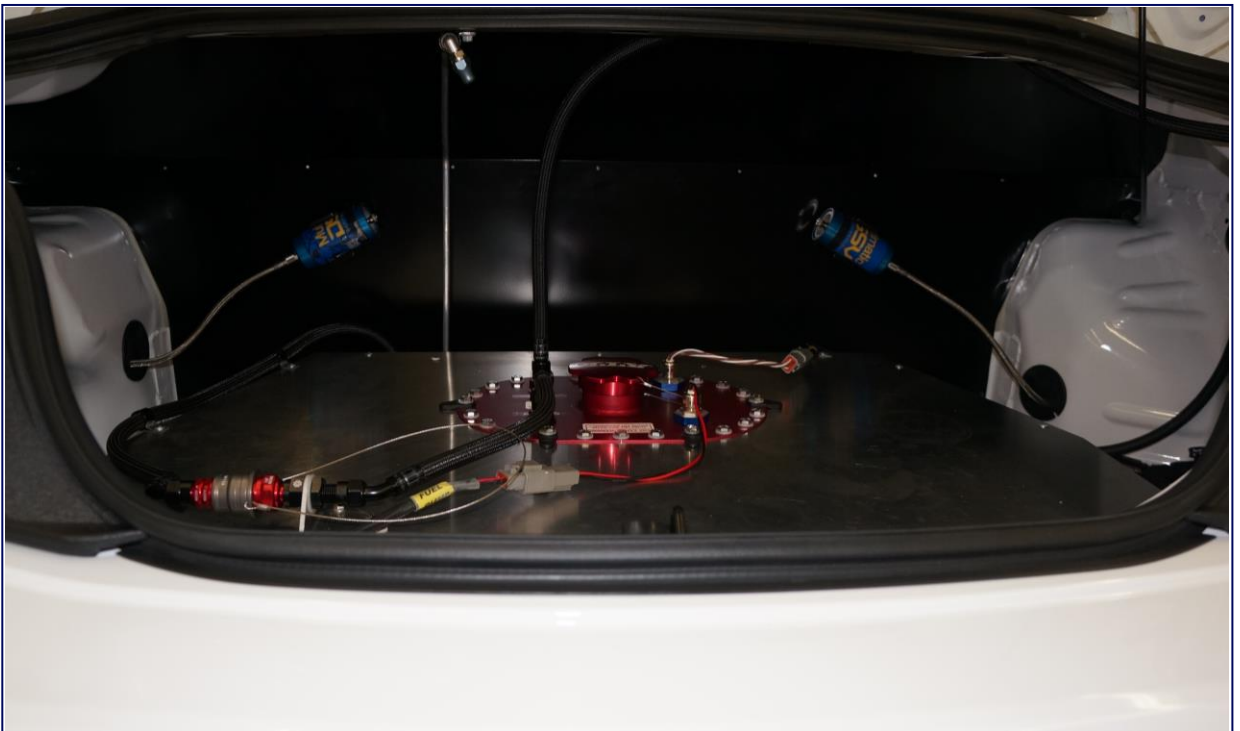

Trunk View

# Interiors



Interiors – View from Driver's Door



Interiors – View from Passenger's Door

# Front Wheel Well

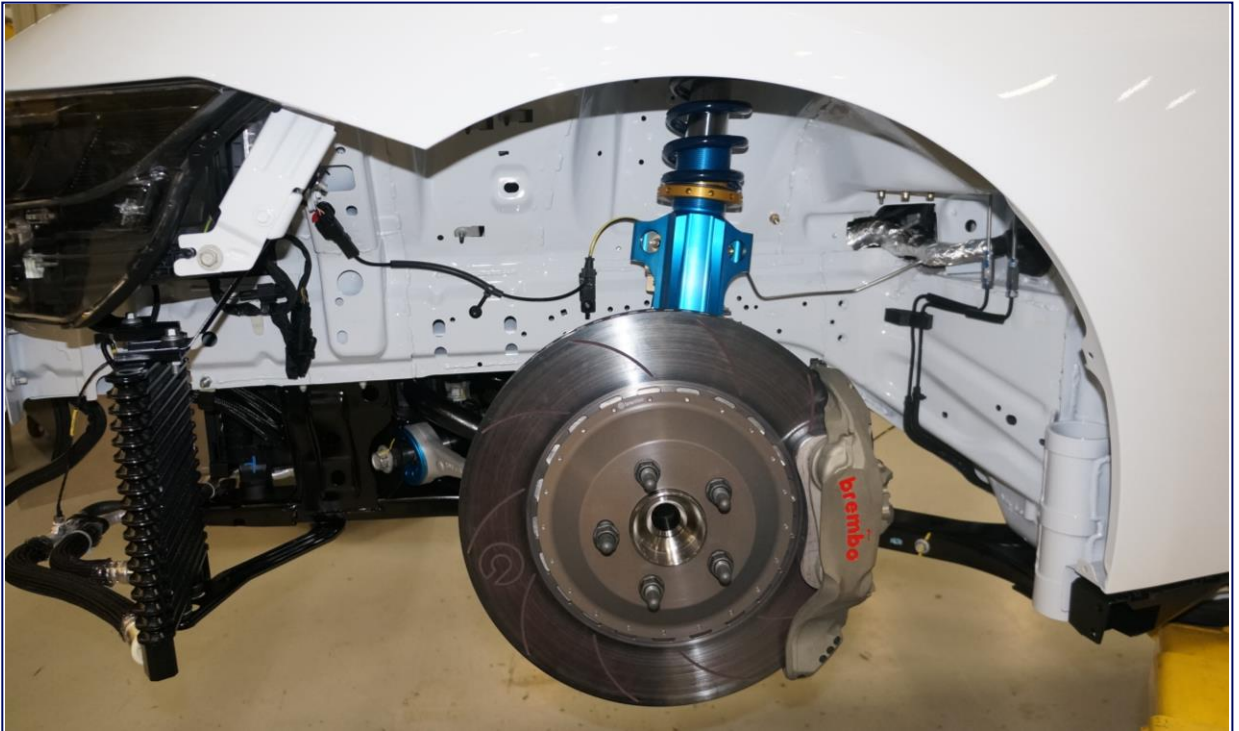

Front Driver Side Wheel Well

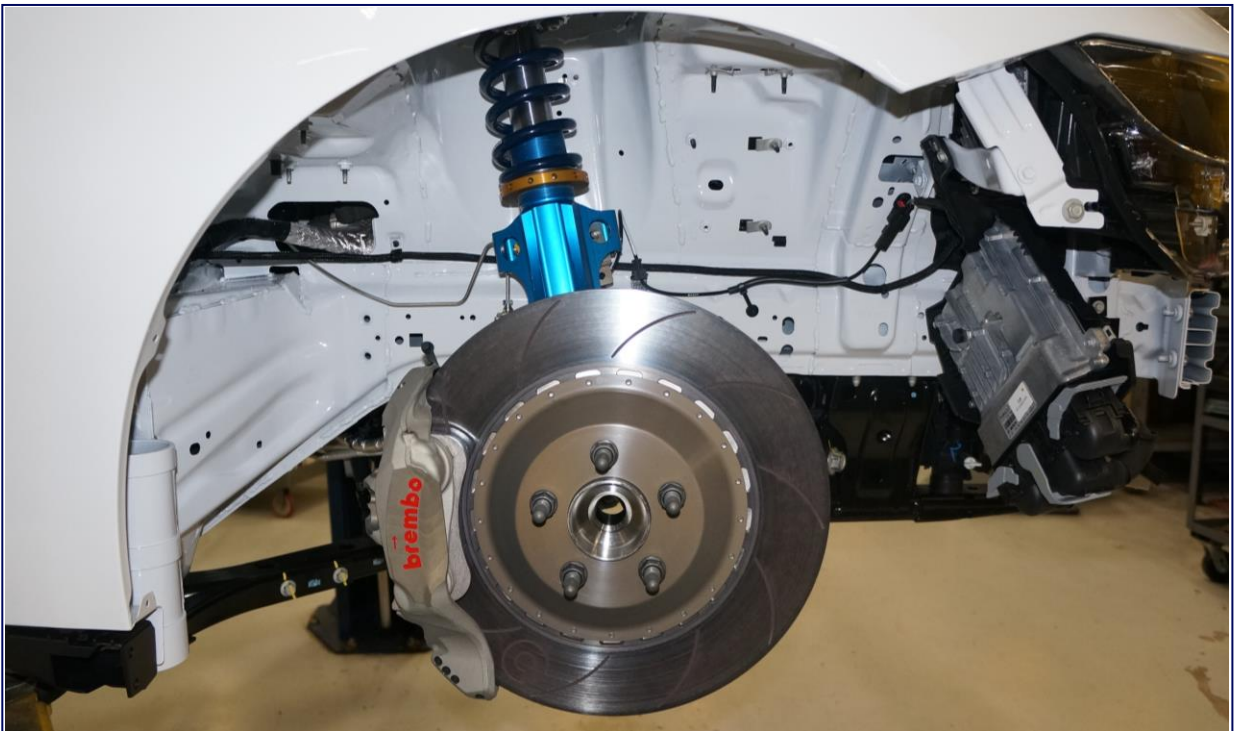

Front Passenger Side Wheel Well

# Rear Wheel Well



Rear Driver Side Wheel Well



Rear Passenger Side Wheel Well

# Bill of Materials

Part Description	Part Number	Qty	Torque Nm	Supplier
<b>Body System</b>				-
Caged BIW S650 Mustang Dark Horse R	CM-607100-S650DHR	1		Technosports
<b>Bodywork Interior</b>				-
Rear View Mirror Kit	JOES-11284	1		HRP
PIA, Mirror	N/A	1		HRP
PIA, Thumb Screw	N/A	2		HRP
PIA, Mounts	N/A	2		HRP
PIA, Screw	N/A	4	0.5	HRP
Dead Pedal Kit	WR-DEADPEDAL	1		Watson
PIA, Mount Bracket	N/A	1		Watson
PIA, Pedal	N/A	1		Watson
Bolt, M6x16	45-20616	5	10	Kimball Midwest
Heat Shield (Driver's Floor)	DHR-FLOOR-HT-SHLD	1		Watson
SS Screw, M6x1	467335	4	10	Kimball Midwest
<b>Dash Panel</b>				-
Main Dash Panel Assembly, Modification	DHR-DASH-MOD	1		Watson
PIA, Main Panel Assembly	N/A	1		Ford Dealer
Bolt, M6x16 (Dash to RH Bracket)	45-20616	4	10	Kimball Midwest
IP Lower Flange (Steel)	PR3Z-63044C52-A	1		Ford Dealer
Bolt / Washer, M6x25	W505425-S450B	4	10	Ford Dealer
Trim Pin, 6.3x2	W711687-S300	1		Ford Dealer
Light Sensor	DG9Z-13A018-AFC	1		Ford Dealer
Center Vents Assembly, Modification	WMOD-C044K30-FB319W	1		Watson
PIA, Center Vents Assembly	PR3Z-63044F58-DA	1		Ford Dealer
Screw, 5x16	W718327-S450B	2	2.5	Ford Dealer
Interior Master Power Panel	DHR-MSTR-PWR-PNL	1		Watson
Headlight Switch (PIA Main Panel Assembly)	PR3Z-11654-AA	1		Ford Dealer
Dash Vent LH	PR3Z-63045F20-BA	1		Ford Dealer
Screw, 4.2x19	W718102-S451	1	2.2	Ford Dealer
Dash Vent, RH	PR3Z-6304388-DA	1		Ford Dealer
Dark Horse Name Plate (on RH Dash Vent)	PR3Z-6304338-AH	1		Ford Dealer
Cover, Lower Steering Column LH	PR3Z-6304459-CA	1		Ford Dealer
Screw, 4.2x25	W719293-S451	1	1.3	Ford Dealer
Cover, Lower Steering Column RH	PR3Z-3530-AB	1		Ford Dealer
Screw, 5x14	W719753-S451	3	1.9	Ford Dealer
Upper Steering Column Shroud, Modified	PR3Z-6304654-BA	1		Ford Dealer
Screw, 4.2x19	W718102-S451	5	2.2	Ford Dealer
Grill Assembly, IP / Defroster Opening	PR3Z-63044E82-AA	1		Ford Dealer
Housing Assembly, IP / Controls	PR3Z-63047A26-BA	1		Ford Dealer
Grill Assembly, IP / Radio	PR3Z-18978-EA	1		Ford Dealer
Panel Assembly, End RH	PR3Z-6304480-AA	1		Ford Dealer
Panel Assembly End LH	PR3Z-6304481-AA	1		Ford Dealer
Dash Panel Closeout	DHR-DASHCLOSEOUT	1		Watson
Button Head Screw, M4-0.7x10	92095A190	6	2.9	McMaster Carr
Button Head Screw, M6-1.0x10	92095A224	2	10	McMaster Carr
<b>Bodywork Exterior</b>				-
Hood Strut RH	PR3Z-16C826-A	1		Ford Dealer
Hood Strut LH	PR3Z-16C826-B	1		Ford Dealer
Hood Side Seal RH	PR3Z-16A238-A	1		Ford Dealer
Hood Side Seal LH	PR3Z-16A239-A	1		Ford Dealer
Hood Front Seal	FR3Z-16740-A	1		Ford Dealer

# Bill of Materials (Cont.)

Part Description	Part Number	Qty	Torque Nm	Supplier
<b>Bodywork Exterior (Cont.)</b>				
Hood Seal (Front Side Panel) RH	JR3Z-16B990-A	1		Ford Dealer
Hood Seal (Front Side Panel) LH	JR3Z-16B991-A	1		Ford Dealer
Hood Scoop	PR3Z-16C630-BAPTM	1		Ford Dealer
Nut / Washer, M4	W701567-S450B	4	5.4	Ford Dealer
Hood Pins, Modification	DHR-HODDPIN-MOD	1		Watson
PIA, Hood Pins	ACH-120-4000	1		HRP
Rivnut, M4x0.7	85411	12		Kimball Midwest
Bumper (Hood Stop)	5R3Z-16758-AA	2		Ford Dealer
Bracket (Rocker Panel to Fender) RH	PR3Z-16A076-C	1		Ford Dealer
Bracket (Rocker Panel to Fender) LH	PR3Z-16A076-D	1		Ford Dealer
Rear Lower Molding Retain RH	PR3Z-6329074-B	1		Ford Dealer
Rear Lower Molding Retain LH	PR3Z-6329075-B	1		Ford Dealer
Nut Insert	N/A	12		Ford Dealer
Screw / Washer, 6.3x25	W701107-S450B	12	3.2	Ford Dealer
Plastic Nut, 5.4mm	F5RZ-17K657-A	12		Ford Dealer
Screw / Washer, 6.3x25	W701107-S450B	6	3.2	Ford Dealer
Core Support	PR3Z-8A284-A	1		Ford Dealer
Bolt / Washer, M8x25	W711806-S450B	4	20	Ford Dealer
Bolt / Washer, M8x45	W714182-S442	4	20	Ford Dealer
Nut Clip, M6	W520822-S439	6		Ford Dealer
Wiper Motor Assembly	FR3Z-17508-B	1		Ford Dealer
Bolt / Washer, M6x35	W707532-S442	3	9	Ford Dealer
Wiper Arm RH	FR3Z-17526-B	1		Ford Dealer
Wiper Arm LH	FR3Z-17527-B	1		Ford Dealer
Nut / Washer, M10	W716490-S450B	2	35	Ford Dealer
Cap	W710461-S300	2		Ford Dealer
Hood Air Deflector	PR3Z-16A238-C	1		Ford Dealer
Rivet Push Pin, 6x18	W705436-S300	8		Ford Dealer
Heat Shield (Footwell / Underside) RH	FR3Z-6310062-A	1		Ford Dealer
Heat Shield (Footwell / Underside) LH	FR3Z-6310063-A	1		Ford Dealer
Nut / Washer, M6 (Heat Shield to Body)	W718611-S900	5	10	Ford Dealer
Battery Tray, Modification	DHR-BATBOX-MOD	1		Watson
PIA, Battery Tray	PR3Z-10732-A	1		Ford Dealer
Bolt, M6x24 (Battery Tray to Hold Down)	W713219-S439	5	10.5	Ford Dealer
Nut, M6	W520812-S439	1	10	Ford Dealer
Battery Tie Down	6F2Z-10756-A	1	8	Ford Dealer
Rocker Panel RH	PR3Z-6310176-AAPTM	1		Ford Dealer
Rocker Panel LH	PR3Z-6310177-AAPTM	1		Ford Dealer
Push Pin (Bottom of Rocker into Body), PIA	W707889-S300	16		Ford Dealer
Rocker Panel Front Scuff	PR3Z-6313208-AB	2		Ford Dealer
C-Bracket (Bottom of K-Frame)	PR3Z-5025-A	1		Ford Dealer
Bolt, M10x30 (Bracket to K-Frame)	W718025-S439	6	62.5	Ford Dealer
Blue Clip, 4.2mm	W716529-S900	2		Ford Dealer
Rear Deflector, Modification	DHR-AIRDEFLCTR-MOD	1		Watson
PIA, Rear Deflector	KR3Z-6P013-B	1		Ford Dealer
Bolt / Washer, M8x25	W711806-S450B	2	30	Ford Dealer
Screw / Washer, 4.2x20	W716345-S450B	5	1.5	Ford Dealer
Bolt / Washer, M8x25	W711806-S450B	2	9	Ford Dealer

# Bill of Materials (Cont.)

Part Description	Part Number	Qty	Torque Nm	Supplier
<b>Bodywork Exterior (Cont.)</b>				
Front Fender Splash Shield RH	PR3Z-16102-D	1		Ford Dealer
Front Fender Splash Shield LH	PR3Z-16103-D	1		Ford Dealer
Screw / Washer, 4.2x25	W715060-S450B	4	2.2	Ford Dealer
Rivet Push Pin, 8.5x27	W707373-S300	4		Ford Dealer
Rivet Push Pin, 6.5x2	W713610-S300	20		Ford Dealer
Rivet Push Pin, 6.5x4.5	W714040-S300	4		Ford Dealer
Frame Side Member RH	PR3Z-5050-A	1		Ford Dealer
Frame Side Member LH	PR3Z-5051-A	1		Ford Dealer
Bolt, M10x30	W718025-S439	8	62.5	Ford Dealer
Blue Clip, 4.2mm	W716529-S900	2		Ford Dealer
Shield Assembly Engine Splash Pan (Underbody)	PR3Z-6775-A	1		Ford Dealer
Screw / Washer, 4.2x25	W715060-S450B	13	2.2	Ford Dealer
Trim Pin, 7.6x20	W709371-S300	2		Ford Dealer
Nut Expansion, 4.2mm	W716529-S900	11		Ford Dealer
Fender Emblem Dark Horse	PR3Z-16228-B	2		Ford Dealer
Decklid Emblem Dark Horse	PR3Z-6342528-J	1		Ford Dealer
Tow Hook Kit, Front	FP-17654-FDH	1		Watson
Tow Hook	N/A	1		Watson
Flat Washer, M10	453510	2		Kimball Midwest
Nylock Nut, M10-1.5	46-5510	2	35	Kimball Midwest
Bolt, M10-1.5x160	91280A670	2		McMaster Carr
Aluminum Spacer, 1" x 1"	92510A826	2		McMaster Carr
Tow Hook Kit, Rear	FP-17954-RDH	1		Watson
PIA, Tow Hook	N/A	1		Watson
PIA, Side Plate	N/A	2		Watson
Fender Washer, 3/8"x1-3/4"	10594	1		Kimball Midwest
Nylock Nut, M10x1.5	46-5510	3	35	Kimball Midwest
Flange Bolt, M10x70	4521070	3	35	Kimball Midwest
Tie Down Kit (Includes Front & Rear Hooks)	M-1700-M	1		Ford Performance Parts
Tie Down, Front	N/A	2		Ford Performance Parts
Tie Down, Rear	N/A	2		Ford Performance Parts
Bolt, M10-1.5x35	N/A	8	74	Ford Performance Parts
Plug, 19x25	W706010-S300	1		Ford Dealer
Plug, 19x0.7	W718717-S300	3		Ford Dealer
Plug, 33.6x0.6	W711539-S300	3		Ford Dealer
Plug, 18x0.7	W702233-S300	2		Ford Dealer
Plug, 30x0.6-1.5	W702351-S300	2		Ford Dealer
Plug, 25.5x1.8	W703638-S300	2		Ford Dealer
Plug, 19x25	W706010-S300	1		Ford Dealer
Cover Plate	F65Z-7K540-AA	2		Ford Dealer
<b>Front Fascia</b>				
Bumper Beam	PR3Z-17757-A	1		Ford Dealer
Panel Grill Opening	PR3Z-8190-BA	1		Ford Dealer
Front Fascia - Front Bumper Cover	PR3Z-17D957-CAPTM	1		Ford Dealer
Screw, 5x16	W506843-S450B	7		Ford Dealer
Seal (Fascia to Hood)	PR3Z-16A238-B	1		Ford Dealer
Grill (Upper)	PR3Z-8200-DAPTM	1		Ford Dealer
Grill (Lower), Modification	DHR-GRLLWR-MOD	1		Watson
PIA, Grill (Lower)	PR3Z-17K945-BAPMT	1		Ford Dealer
Screw / Washer, 4.2x20	W716345-S450B	4	2.2	Ford Dealer



# Bill of Materials (Cont.)

Part Description	Part Number	Qty	Torque Nm	Supplier
<b>Front Fascia (Cont.)</b>				
Grill Assembly (Lower) RH	PR3Z-17B968-DAPTM	1		Ford Dealer
Grill Assembly (Lower) LH	PR3Z-17E811-DBPTM	1		Ford Dealer
Bumper Isolator Assembly, Modification	DHR-GRILLUPR-MOD	1		Watson
Isolator Front Bumper	PR3Z-17C882-C	1		Ford Dealer
Duct, to Trans Cooler (Lower Grill RH)	PR3Z-8310-J	1		Ford Dealer
Duct, to Oil Cooler (Lower Grill) LH	PR3Z-8311-F	1		Ford Dealer
Front Tow Hook Opening Cover	PR3Z-17E811-B	1		Ford Dealer
Trim (Lower Fascia) RH	PR3Z-17E810-AAPTM	1		Ford Dealer
Trim (Lower Fascia) LH	PR3Z-17E811-AAPTM	1		Ford Dealer
Screw / Washer, 4.2x20	W716345-S450B	2	2.2	Ford Dealer
Front Fascia Mounting Bracket	PR3Z-17C897-A	1		Ford Dealer
Bolt / Washer, M6x20	W705134-S450B	6	4.8	Ford Dealer
Front Lower Valance	PR3Z-17626-AA	1		Ford Dealer
Screw / Washer, 4.2x20	W716345-S450B	2	2.2	Ford Dealer
Grill Cowl Top Assembly, Modification	DHR-COWEL-MOD	1		Watson
PIA, Grill Assembly Cowl Top Vent	PR3Z-63022A68-AA	1		Ford Dealer
Rivet Push Pin, 8.5x7	W718365-S300	4		Ford Dealer
Trim Pin, 20x7x23	W706815-S300	1		Ford Dealer
Grommet, 9.25x0.8	W709629-S300	1		Ford Dealer
Deflector Radiator Air Rear	PR3Z-8310-H	1		Ford Dealer
Screw / Washer, 4.2x25	W715060-S450B	22	2.2	Ford Dealer
Nut Expansion, 4.2mm	W716529-S900	4		Ford Dealer
Rivet Push Pin, 7.6x20	W709371-S300	3		Ford Dealer
PIA, Nut Spring	N/A	12		Ford Dealer
Air Intake Duct LH	N/A	1		Ford Dealer
Air Intake Duct RH	N/A	1		Ford Dealer
Brake Duct Mounting Bracket Kit	DHR-BRK-DCT-MNT-BRKT	2		Watson
Brake Duct Bracket Upper	N/A	2		Watson
Brake Duct Bracket Lower	N/A	2		Watson
Rivet, 1/4"	PR42-SSP	16		Kimball Midwest
Brake Duct Hose Kit	LCR-DH-BHK	1		Capaldi Racing
PIA, Hose	N/A	2		Capaldi Racing
PIA, Clamp	N/A	4		Capaldi Racing
Brake Duct Inlets Kit	LCR-DH-BDK	1		Capaldi Racing
PIA, RH Inlet	N/A	1		Capaldi Racing
PIA, LH Inlet	N/A	1		Capaldi Racing
Radiator Closeout	DHR-RADCLOSEOUT	1		Watson
PIA, Rad Shroud Closeout LH	N/A	1		Watson
PIA, Rad Shroud Closeout RH	N/A	1		Watson
PIA, Rad Shroud Closeout Middle	N/A	1		Watson
PIA, Rad Shroud Cover Top	N/A	1		Watson
PIA, Fan Shroud Cover Top	N/A	1		Watson
PIA, Oil Cooler Panel Upper	N/A	1		Watson
PIA, Rad Shroud Panel Lower	N/A	1		Watson
PIA, Oil Cooler Panel Lower	N/A	1		Watson
PIA, Rad Duct Support	N/A	1		Watson
Rivet, 1/4"	PR42-SSP	38		Kimball Midwest
Clip-on Gasket, 185"	12335A42	1		McMaster Carr
Nylock Nut, M6-1.0	46-5506	2	10	Kimball Midwest
Grommet	9307K217	2		Kimball Midwest

# Bill of Materials (Cont.)

Part Description	Part Number	Qty	Torque Nm	Supplier
<b>Front Fascia (Cont.)</b>				
Radiator Closeout (Cont.)				
Hex Flange Bolt, M6x25	45-20625	4	10	Kimball Midwest
Rivnut, M6-1.0	85413	8		Kimball Midwest
Screw / Washer, M6x20	W705968-S439	8	10	Ford Dealer
<b>Trunk/ Rear</b>				-
Vent, Under Rear Fascia	3C3Z-54280B62-DA	2		Ford Dealer
Trunk Seal (Rubber)	FR3Z-6343720-A	1		Ford Dealer
Deck Lid Strut	PR3Z-63406A10-C	2		Ford Dealer
Bracket (Rear Closeout) RH	FR3Z-17D942-G	1		Ford Dealer
Bracket (Rear Closeout) LH	FR3Z-17D943-H	1		Ford Dealer
Bolt / Washer, M6x25	W711158-S442	2	10.5	Ford Dealer
J-Clip, M6	W520812-S439	2		Ford Dealer
Wing	PR3Z-6344210-EC	1		Ford Dealer
Bolt / Washer, M6x13	W722355-S442	2	8	Ford Dealer
Decklid Panel	PR3Z-6344210-BDPTM	1		Ford Dealer
Screw / Washer, 4.2x20	W716345-S450B	4	2.5	Ford Dealer
Nut / Washer, M6	W520521-S442	5	5.4	Ford Dealer
Bolt / Washer, M6x13	W722355-S442	2	5.4	Ford Dealer
Wing Wicker	DHR-WING-EXTEN	1		Watson
Striker (Inside Trunk to Body)	AH6Z-5443252-A	1		Ford Dealer
Bolt / Washer, M6x18	W505423-S307	2	10	Ford Dealer
Latch (Deck Lid to Striker), Modification	WMOD-7643282-BB	1		Watson
PIA, Latch (Deck Lid to Striker)	FR3Z-7643200-B	1		Ford Dealer
Nut / Washer, M6	W520521-S442	3	10	Ford Dealer
Trunk Release Cable	MA014RL24CL	1		Sparco SPA
P-Clamp, 1/4"	26461	3		Kimball Midwest
Bolt, M6x16	W505253-S439	3		Ford Dealer
Crimp Joint	3883T22	1		McMaster Carr
Shrink Tube, 0.5" long	269821	2		Kimball Midwest
Luggage Compartment Door Bumper	PR3Z-7840452-A	2		Ford Dealer
Rear Closeout	DHR-REARCLOSEOUT-AS	1		Watson
PIA, Closeout Lower	N/A	1		Watson
PIA, Closeout Upper	N/A	1		Watson
PIA, Grommet Plate	N/A	1		Watson
Grommet, 3/8" ID	26-814	1		Kimball Midwest
Grommet, 5/16" ID	26-810	1		Kimball Midwest
Grommet, 1" ID	9307K74	1		McMaster Carr
Grommet, 1/4" ID	26-808	1		Kimball Midwest
Rivet, 3/16"	48-3620	4		Kimball Midwest
Rivet, 1/4"	PR42-SSP	26		Kimball Midwest
<b>Rear Fascia</b>				-
Bumper	FR3Z-17906-A	1		Ford Dealer
Rear Bumper Isolator	PR3Z-17E855-C	1		Ford Dealer
Rear Fascia Bracket, to Body RH	PR3Z-17C947-C	1		Ford Dealer
Rear Fascia Bracket, to Body LH	PR3Z-17E855-A	1		Ford Dealer
Rear Fascia	PR3Z-17K835-AAPTM	1		Ford Dealer
Screw / Washer, 4.2x20	W716345-S450	2	2.2	Ford Dealer
Screw / Washer, 4.2x25	W715060-S450B	8	2.2	Ford Dealer
Push Pin, 6.5x4.5	W714040-S300	4		Ford Dealer
Nut Expansion-White	W719745-S300	2		Ford Dealer

# Bill of Materials (Cont.)

Part Description	Part Number	Qty	Torque Nm	Supplier
<b>Rear Fascia (Cont.)</b>				
Rear Fascia Bracket, to Body (Center Mount)	PR3Z-17754-AA	1		Ford Dealer
Screw / Washer, 4.8x19	W700092-S450	4	1.9	Ford Dealer
Nut Expansion-Blue	W721035-S439	4		Ford Dealer
Screw / Washer, 4.8x19	W700092-S450	6	1.9	Ford Dealer
Nut Expansion-Blue	W721035-S439	6		Ford Dealer
Rear Fascia Bracket, to Body (Side Mount) RH	PR3Z-17D942-C	1		Ford Dealer
Rear Fascia Bracket, to Body (Side Mount) LH	PR3Z-17D943-C	1		Ford Dealer
Screw / Washer, 4.8x19	W700092-S450	10	1.9	Ford Dealer
Nut Expansion-Blue	W721035-S439	10		Ford Dealer
Rear Fascia Bracket, to Body (Lower Mount) RH	PR3Z-17D942-A	1		Ford Dealer
Rear Fascia Bracket, to Body (Lower Mount) LH	PR3Z-17D943-A	1		Ford Dealer
Screw / Washer, 4.8x19	W700092-S450	4	1.9	Ford Dealer
Nut Expansion-Blue	W721035-S439	4		Ford Dealer
Marker Light RH	PR3Z-15A101-A	1		Ford Dealer
Marker Light LH	PR3Z-15A201-E	1		Ford Dealer
Rear Lower Valance	PR3Z-17F828-EA	1		Ford Dealer
Screw / Washer, 4.2x20	W716345-S450B	6	2.2	Ford Dealer
Rivet Push Pin, 6.5x4.5	W714040-S300	4		Ford Dealer
Reflector RH	JR3Z-15A448-A	1		Ford Dealer
Reflector LH	JR3Z-15A449-A	1		Ford Dealer
<b>Door</b>				
Striker	JX7Z-5822008-B	2		Ford Dealer
Striker Pad	JX7Z-58218K02-A	2		Ford Dealer
Bolt, M8x27 (Striker to Body)	W717729-S437M	4	20	Ford Dealer
Front Door Glass Frame & Molding Assembly RH	PR3Z-63214A62-A	1		Ford Dealer
Front Door Glass Frame & Molding Assembly LH	PR3Z-63214A63-A	1		Ford Dealer
Bolt / Washer, M6x14	W706069-S442	4	9	Ford Dealer
Bolt, M6x17	W703429-S450	2	9	Ford Dealer
Latch Assembly RH	N/A	1		Ford Dealer
Reinforcement	PR3Z-6326684-A	1		Ford Dealer
Link	PR3Z-6322152-A	1		Ford Dealer
Latch	NB5Z-5821812-A	1		Ford Dealer
Shield	PR3Z-3621978-A	1		Ford Dealer
Door Latch LH	DHR-DOORLTCHCABL	1		Watson
Latch Assembly LH	N/A	1		Ford Dealer
Link	PR3Z-6322152-A	1		Ford Dealer
Reinforcement	PR3Z-6326685-A	1		Ford Dealer
Latch	NB5Z-5821813-A	1		Ford Dealer
Shield	PR3Z-3621979-A	1		Ford Dealer
Plug Button, 19x0.7	W718717-S300	2		Ford Dealer
Bolt, M6x13 (Latch to Door)	W715340-S450B	6	8	Ford Dealer
P-Clamp, 1/4"	26-461	1		Kimball Midwest
Nylock Nut, M6-1.0	46-5506	1	10	Kimball Midwest
Bolt, M10-1.0	241958	1	10	Kimball Midwest
Door Handle RH	PR3Z-6322404-AA	1		Ford Dealer
Door Handle LH	PR3Z-6322405-AA	1		Ford Dealer
Mirror Assembly RH	PR3Z-17682-H	1		Ford Dealer
Mirror Assembly LH	PR3Z-17683-H	1		Ford Dealer
Bolt / Washer, M6x20	W716914-S307	4	9	Ford Dealer
Nut / Washer, M6	W710771-S442	2	9	Ford Dealer

# Bill of Materials (Cont.)

Part Description	Part Number	Qty	Torque Nm	Supplier
<b>Door (Cont.)</b>				
Mirror Cover RH	FR3Z-17D742-AAPTM	1		Ford Dealer
Mirror Cover LH	FR3Z-17D743-AAPTM	1		Ford Dealer
Bezel (Door Lock) RH	PR3Z-63218A14-A	2		Ford Dealer
Weatherstrip - Front Door Glass at Belt Outside RH	PR3Z-6321452-A	1		Ford Dealer
Weatherstrip - Front Door Glass at Belt Outside LH	PR3Z-6321453-A	1		Ford Dealer
Weatherstrip - Front Door RH	PR3Z-6320530-A	1		Ford Dealer
Weatherstrip - Front Door LH	PR3Z-6320531-A	1		Ford Dealer
Weatherstrip - Front Body Pillar RH	PR3Z-6302564-B	1		Ford Dealer
Weatherstrip - Front Body Pillar RH	PR3Z-6302564-A	1		Ford Dealer
Screw, 4.2x13	W711129-S450B	12	1	Ford Dealer
Nut - Yellow	W703027-S300	12		Ford Dealer
PIA, Pin	N/A	1		Ford Dealer
Weatherstrip - Front Body Pillar LH	PR3Z-6302565-B	1		Ford Dealer
Weatherstrip - Front Body Pillar LH	PR3Z-6302565-A	1		Ford Dealer
Screw, 4.2x13	W711129-S450B	12	1	Ford Dealer
Nut - Yellow	W703027-S300	12		Ford Dealer
PIA, Pin	N/A	1		Ford Dealer
Door Foam LH	DHR-IMPAXX-LHFOAM	1		Watson
Panel (Covers Foam Inside Door)	DHR-INNR-DOOR-PNL	1		Watson
Rivet, 1/8"	PR3Z-SSP	15		Kimball Midwest
<b>Glass</b>				-
Quarter Window RH	PR3Z-6329710-A	1		Ford Dealer
Quarter Window LH	PR3Z-6329711-A	1		Ford Dealer
Rear Window	PR3Z-6342006-A	1		Ford Dealer
Windshield	PR3Z-6303100-B	1		Ford Dealer
Windo-Weld (Urethane) (Glass Installation)	N/A	4		R.S. Hughes
Primer	N/A	0.25		R.S. Hughes
<b>Engine</b>				-
Sealed Engine	FP-6007-DHR	1		Technosports
Engine Assembly	N/A	1		N/A
Engine, Requires Rework at PAS	N/A	1		N/A
Cap, Oil 5W50	N/A	1		Ford Dealer
Vac Hose Cap (on Intake)	64087	1		Kimball Midwest
Oetiker Clamp, 14.5mm	16700013	1		Grainger
Insulator (Mount Engine to K-Frame)	MR3Z-6038-A	2		Ford Dealer
Bolt / Washer, M10x46 (Insulator to K-Frame)	W713078-S439	4	62.5	Ford Dealer
Nut (Engine to Insulator), M10	W712530-S440	2	62.5	Ford Dealer
Bracket (Mount to Engine Block) RH	BR3Z-6028-C	1		Ford Dealer
Bolt / Stud, M10x55+M10x20 (Bracket to Block)	W714924-S900	2	62.5	Ford Dealer
Bolt, M10x55 (Bracket to Block)	W500723-S439	2	62.5	Ford Dealer
Bracket (Mount to Engine Block) LH	BR3Z-6031-C	1		Ford Dealer
Bolt / Stud, M10x55+M10x20 (Bracket to Block)	W714924-S900	2	62.5	Ford Dealer
Bolt, M10x55 (Bracket to Block)	W500723-S439	2	62.5	Ford Dealer
Starter Motor	PR3Z-11002-B	1		Ford Dealer
Bolt, M10x80	W714012-S439	1	47.5	Ford Dealer
Stud, M10x42	W715721-S437	1	47.5	Ford Dealer
Nut / Washer, M6	W716298-S450	1	6.2	Ford Dealer
Nut / Washer, M8	W711953-S900	2	12	Ford Dealer
Air Box / Zip Tube Assembly LH, Modification	WMOD-9C662-BP	1		Watson
Modification Air Cleaner	DHR-AIRTUBE-MOD	1		Watson

# Bill of Materials (Cont.)

Part Description	Part Number	Qty	Torque Nm	Supplier
<b>Engine (Cont.)</b>				
Air Box / Zip Tube Assembly LH	PR3Z-9600-G	1		Ford Dealer
Bolt / Washer, M6x40	W505428-S442	1	8	Ford Dealer
Vacuum Cap, 5/8"	660-1696	1		NAPA
Oetiker Clamp, 23.5mm	16700028	1		Grainger
Air Box / Zip Tube Assembly RH, Modification	WMOD-9C662-CP	1		Watson
Modification Air Cleaner	DHR-AIRTUBE-MOD	1		Watson
Air Box / Zip Tube Assembly RH	PR3Z-9600-H	1		Ford Dealer
Bolt / Washer, M6x40	W505428-S442	1	8	Ford Dealer
Duct - Air Cleaner (Connects to Airbox) RH	PR3Z-9C675-B	1		Ford Dealer
Duct - Air Cleaner (Connects to Airbox) LH	PR3Z-9C675-A	1		Ford Dealer
Air Box Bracket, Connects to Fuse Panel Bracket	PR3Z-9647-A	1		Ford Dealer
U-Clip, M6	W520802-S439	6		Ford Dealer
Bolt / Washer, M6x25	W505425-S442	5	8	Ford Dealer
Air Box Bracket	PR3Z-9647-B	1		Ford Dealer
U-Clip, M6	W520802-S439	3		Ford Dealer
Bolt / Washer, M6x20	W505424-S439	3	8	Ford Dealer
Fuel Pump Shield	JR3Z-9A397-B	1		Ford Dealer
Fuel Injector Insulator	JR3Z-9K540-F	1		Ford Dealer
Bolt / Washer, M8x80	W719295-S450	1	30	Ford Dealer
Tensioner	JR3Z-6B209-A	1		Ford Dealer
Bolt, M10x70	W709638-S439	1	47.5	Ford Dealer
Belt	PR3Z-8620-C	1		Ford Dealer
Oil Cooler (Setrab, M22)	SET50-960-7612	1		HRP
Adapter, M22-AN12	M22AN12-SE	2		HRP
Bolt, M6x20 (Oil Cooler to Shroud)	W705968-S439	8	10	Ford Dealer
Oil Cooler Lines Kit	DHR-OIL-CLR-LINES	1		Watson
PIA, Engine Out / Cooler In	N/A	1		Watson
PIA, Cooler Out / Engine In	N/A	1		Watson
P-Clamp, 1"	26-478	1		Kimball Midwest
Washer, M6	453506	2		Kimball Midwest
Nylock Nut, M6x1.0	46-5506	1	10	Kimball Midwest
Button Head Screw, M6-1.0x20	96452A723	1	10	McMaster Carr
Oil Fitting Adapters Kit	LCR-OCA-12	1		Capaldi Racing
Catch Can Kit, -10 AN	DHR-CATCHCAN	1		Watson
Catch Can, -10 AN	N/A	1		Watson
Vent Hose, Short RH	N/A	1		Watson
Vent Hose, Long LH	N/A	1		Watson
Bracket, Catch Can	N/A	1		Watson
PCV Vacuum Line Connector	7T4Z-9E499-B	2		Watson
Crankcase Vent Tube (Donor Part)	PR3Z-6758-A	2		Ford Dealer
Fitting (on Oil Pan, Connects to Catch Can Drain back Hose)	989006	1		XRP Inc
Catch Can Bracket	N/A	1		Watson
Bolt / Washer, M6x20	W505424-S442	2	6.2	Ford Dealer
Bolt / Washer, M6x16	W505253-S450L	2	10	Ford Dealer
P-Clamp, 1/2"	26464	1		Kimball Midwest
Catch Can to Oil Pan Drain Back Hose	CATCH-CAN-DRAINBACK-HOSE	1		Watson

# Bill of Materials (Cont.)

Part Description	Part Number	Qty	Torque Nm	Supplier
<b>Cooling</b>				-
Tank Assembly (Radiator Supply)	PR3Z-8A080-A	1		Ford Dealer
Bolt / Washer, M6x20	W721207-S442	2	8	Ford Dealer
Stud / Washer, M6x20	W719496-S442	1	8	Ford Dealer
U-Nut, M6	W520802-S439	1		Ford Dealer
Cap (Tank Assembly)	DG9Z-8100-A	1		Ford Dealer
Hose Assembly (Rad Overflow)	PR3Z-8075-K	1		Ford Dealer
Upper Hose Assembly (Rad to Engine)	PR3Z-8260-B	1		Ford Dealer
Lower Hose Assembly (Rad to Engine)	PR3Z-8286-B	1		Ford Dealer
Fan Motor / Shroud	PR3Z-8C607-A	1		Ford Dealer
Bolt / Washer, M6x20 (Shroud to Rad)	W505424-S442	2	6.2	Ford Dealer
Radiator Assembly	PR3Z-8005-A	1		Ford Dealer
Insulator (Lower Rad Support in K-Frame)	XW4Z-8124-AA	2		Ford Dealer
Bracket (Upper Rad Support to Core Support)	JR3Z-8A193-A	2		Ford Dealer
Bolt / Washer, M6x25 (Bracket to Core Support)	W505425-S450B	4	10.5	Ford Dealer
Hose Assembly - Engine Cooler Reservoir	PR3Z-8075-J	1		Ford Dealer
Heater Hose	WR-18K580-MOD	1		Watson
Fitting (90deg) and Clamp	PR3Z-18472-S	1		Ford Dealer
Hose, 3ft	H152	1		NAPA
Heat Shield, 3ft	FS-12-BK-BR	1		Michigan Valve & Fitting Inc
Hose - Radiator Supply Tank	PR3Z-8A365-CA	1		Ford Dealer
<b>Exhaust System</b>				-
Rear Hanger RH	JR3Z-5260-A	1		Ford Dealer
Rear Hanger LH	JR3Z-5277-A	1		Ford Dealer
Bolt / Washer, M8x26 (Hanger to Body)	W718205-S439	4	25	Ford Dealer
Exhaust Hanger (to Rear Sub-Frame)	FR3Z-5A242-E	2		Ford Dealer
U-Nut, M8	W709990-S439	2		Ford Dealer
Bolt, M8x25	W712977-S439	2	30	Ford Dealer
Exhaust Gasket LH	GR3Z-9448-C	1		Ford Dealer
Exhaust Gasket RH	FR3Z-9448-A	1		Ford Dealer
Full Exhaust	FP-5200-DHR	1		Borla
PIA, RH Tail Pipe	N/A	1		Borla
PIA, LH Tail Pipe	N/A	1		Borla
PIA, X-Pipe	N/A	1		Borla
PIA, RH Collector Pipe	N/A	1		Borla
PIA, LH Collector Pipe	N/A	1		Borla
PIA, Clamp	N/A	6		Borla
Headers Kit	FP-9430-DHR	1		Borla
PIA, RH Header	N/A	1		Borla
PIA, LH Header	N/A	1		Borla
Header Bolt, M10x1.25x25	454633	16	32	Kimball Midwest
<b>Fuel System</b>				-
Fuel Supply Tube to Engine	PR3Z-9J280-J	1		Ford Dealer
Fuel Door	PR3Z-63405A26-A	1		Ford Dealer
Housing (Fuel Tank Filler)	PR3Z-6327936-A	1		Ford Dealer
Fuel Cell Fill Plate	N/A			Capaldi Racing
PIA, Bolt	N/A		3.5	Capaldi Racing
Fuel Tank Assembly	N/A	1		Ford Dealer
Fuel Cell Bladder Assembly	LCR-DH-FUELCELL	1		Capaldi Racing
Fuel Pump	NR3Z-9350-A	1		Ford Dealer

# Bill of Materials (Cont.)

Part Description	Part Number	Qty	Torque Nm	Supplier
<b>Fuel System (Cont.)</b>				
Plate (Fuel Pump Block Off)	DHR-FUELPMPBLKOFF	2		Watson
Rivet, 1/8"	PR4Z-SSP	8		Kimball Midwest
Grommet, 5/8" ID	26-822	2		Kimball Midwest
Fuel Cell Spacer and Lid Kit	DHR-FUEL-SPACER	1		Watson
Bolt, M4-0.7x16	M04CM016KBFAS7380FLZB	24	2.2	Global Fastener
PIA, Lid	N/A	1		Watson
PIA, Spacer	N/A	1		Watson
Fuel Vent Hose	DHR-FUELVENTHOSE	1		Watson
-6 Hose, 94.5" long	AR-06-P	1		Watson
Fitting, -6 Straight	AC-06-F4	1		Watson
P-Clamp, 1/2"	26464	5		Kimball Midwest
Shrink Tube 3/4", 1.5" long	26994	1		Kimball Midwest
Bolt, M6-1.0x16	4520616	4	10	Kimball Midwest
Grommet, 5/8"	26-822	1		Kimball Midwest
Rivnut, M6-1.0	85413	4		Kimball Midwest
Bracket, Dry Break	DHR-DRY-BRKT	1		Watson
Washer, M5	454505	2		Kimball Midwest
Nylock Nut, M5-0.8	46-5505	2	4	Kimball Midwest
Screw, M5x12	463271	2	4	Kimball Midwest
Fuel Lines and Fittings Kit	DHR-FUEL-LINES	1		Watson
Factory to Bulkhead	N/A	1		Watson
Bulkhead to Quick Release	N/A	1		Watson
Quick Release to Cell	N/A	1		Watson
Fuel Supply Tube Assembly, Modification	WMOD-9J280-DC	1		Watson
Fuel Supply Tube Assembly	PR3Z-9J280-D	1		Ford Dealer
Ball Locking Break Socket (Red)	STA-SPT08.3655/LJKV	1		HRP
Ball Locking Break Plug (Red)	STA-SPT08.7655/LJKV	1		HRP
Fitting, -6AN Male Bulkhead to -6FM outlet (Black)	GEN-GA3186	1		HRP
<b>Chassis System</b>				
-				
Bearing Kit for Front & Rear Control Arms	SBK-60-1000	1		Cortex
PIA, Front Bearing RH / LH	N/A	2		Cortex
PIA, Front Bearing Spacers	N/A	4		Cortex
PIA, Front Bearing Inserts	N/A	2		Cortex
PIA, Front Bearing Clip, Insert	N/A	2		Cortex
PIA, Rear Bearing RH / LH	N/A	2		Cortex
PIA, Rear Bearing Spacers	N/A	4		Cortex
PIA, Rear Bearing Inserts	N/A	2		Cortex
PIA, Rear Bearing Clip, Insert	N/A	2		Cortex
Mustang Suspension Kit	FP-18000-DHR	1		Technosports
PIA, Strut Damper Assembly, Front RH	56656-5002	1		Technosports
PIA, Strut Damper Assembly Front LH	56656-5002	1		Technosports
PIA, Damper Assembly, Rear RH	56656-5001	1		Technosports
PIA, Damper Assembly Rear LH	56656-5000	1		Technosports
PIA, Damper Canister Mounting Clips	086-007	4		Technosports
PIA, Camber Plate Kit	FP-CAMBER-DHR	1		Watson
Rivet	POPSSD62SSBS	8		Reid
<b>Frame &amp; Mounting System</b>				
-				
K Member, Modification	WMOD-5C145-A	1		Watson
PIA, K Member	PR3Z-5C145-A	1		Ford Dealer
Bolt / Ret, M12x121 (K Member, Back)	W711810-S439	4	115	Ford Dealer

# Bill of Materials (Cont.)

Part Description	Part Number	Qty	Torque Nm	Supplier
<b>Frame &amp; Mounting System (Cont.)</b>				
K Member, Modification (Cont.)				
Bolt / Ret, M12x144 (K Member, Front)	W711805-S439	4	115	Ford Dealer
Plastic Push Pin, K Member	W706358-S300	8		Ford Dealer
Bolt / Washer, M12x59 (K Member)	W717325-S439	4	115	Ford Dealer
Nut, K Member, M12	W707246-S440	8	115	Ford Dealer
Blue Clip, 4.2mm	W716529-S900	15		Ford Dealer
Nut Clip, M6	W520812-S439	2		Ford Dealer
Subframe, Rear, Modification	DHR-SUBFRAME-MOD	1		Watson
Subframe, Rear	N/A	1		Ford Dealer
Bushing Kit (Diff)	DHR-4425-M	1		Watson
Bushing Kit (Body)	DHR-5872-M	1		Watson
Bracket (Body to Subframe) LH	FR3Z-5077-A	1		Ford Dealer
Bracket (Body to Subframe) RH	FR3Z-5084-A	1		Ford Dealer
Bolt, M10x35 (Bracket to Body)	W506435-S439	4	55	Ford Dealer
Bolt / Washer, M14x120 (Subframe to Body)	W717827-S900	4	175	Ford Dealer
Bolt, M12x35	W718383-S439	4	103	Ford Dealer
<b>Front Suspension</b>				
Knuckle Assembly RH (S550)	NR3Z-3K185-A	1		Ford Dealer
Knuckle Assembly LH (S550)	NR3Z-3K186-A	1		Ford Dealer
Hub / Bearing Assembly	PR3Z-1109-D	2		Ford Dealer
Bolt, M14x62.5	W721525-S439	8	150	Ford Dealer
Bolt, M16x72	W715932-S439	4	250	Ford Dealer
Nut, M16	W520517-S450	4	250	Ford Dealer
Wheel Stud & Nut Kit	M-1107-E	2		Ford Performance Parts
Stud, M14x54	10-0002	10	N/A	Kimball Midwest
Nut, M14	40-0001-B	10	122	Kimball Midwest
Arm RH - Lower Front Assembly	DHR-FCNTRLBRNG-MOD	1		Watson
Arm RH - Lower Front	PR3Z-3082-B	1		Ford Dealer
Bolt, M16x92	W711479-S439	1	250	Ford Dealer
Bolt, M16x117	W710755-S439	1	250	Ford Dealer
Nut, M14	W520215-S440	2	103	Ford Dealer
Arm LH - Lower Front Assembly	DHR-FCNTRLBRNG-MOD	1		Watson
Arm LH - Lower Front	PR3Z-3083-B	1		Ford Dealer
Bolt, M16x92	W711479-S439	1	250	Ford Dealer
Bolt, M16x117	W710755-S439	1	250	Ford Dealer
Nut, M14	W520215-S440	2	103	Ford Dealer
Arm RH - Lower Lateral	PR3Z-3078-B	1		Ford Dealer
Arm LH - Lower Lateral	PR3Z-3079-B	1		Ford Dealer
Bolt / Washer, M12x40 (for ARB)	W717732-S439	4	110	Ford Dealer
Adjustable Link (Front Anti Roll Bar)	S650-DHR-FRONT-SWAY-BAR-ASSY	1		Watson
Nylock Nut, 7/16-20	34-8507	2	81	Kimball Midwest
Nylock Nut, 1/2-20	34-8508	2	108	Kimball Midwest
Washer, 1/2"	373908	2		Kimball Midwest
Cap Screw, 7/16-20x2	390716	2	81	Kimball Midwest
Cap Screw, 1/2-20x2.5	390820	2	108	Kimball Midwest
Anti Roll Bar, Front	FR3Z-5482-J	1		Ford Dealer
Bushing for Anti Roll Bar, Front	FR3Z-5484-C	2		Ford Dealer
Clamp (Anti Roll Bar to K-Frame)	FR3Z-5486-A	2		Ford Dealer
Bolt / Washer, M12x40 (Clamp To K-Frame)	W717732-S439	4	110	Ford Dealer
Spring, Front	187B0700	2		HRP



# Bill of Materials (Cont.)

Part Description	Part Number	Qty	Torque Nm	Supplier
<b>Front Suspension (Cont.)</b>				
Spring Bearing Kit, Front (2.5")	GEN-GC1015	2		HRP
Bolt, M16x72 (Damper to Knuckle)	W715932-S439	4	250	Ford Dealer
Nut, Damper to Knuckle	W520517-S450	4	250	Ford Dealer
Bracket, Brake Line	S650-DHR-RH-FRT-BRAKE-LINE-BRKT	2		Watson
Bracket, ABS Wire	S650-DHR-FRT-ABS-WIRE-BKRT-ASSY	2		Watson
Screw, M6x20	W505424-S442	4	6.2	Ford Dealer
X-Tree Tie Mount	T-50RTM	2		Kimball Midwest
<b>Rear Suspension</b>				
Lower Control Arm RH	N/A	1		Watson
PIA, Lower Control Arm RH	PR3Z-5500-D	1		Ford Dealer
Bolt, M16x97	W716992-S439	1	225	Ford Dealer
Bolt, M16x114	W717065-S439	1	250	Ford Dealer
Lower Control Arm LH	N/A	1		Watson
PIA, Lower Control Arm LH	PR3Z-5500-E	1		Ford Dealer
Bolt, M16x97	W716992-S439	1	225	Ford Dealer
Bolt, M16x114	W717065-S439	1	250	Ford Dealer
Upper Control Arm RH	FR3Z-5500-C	1		Ford Dealer
Bolt / Washer, M12x104	W716795-S439	1	115	Ford Dealer
Nut, M12 (to Subframe)	W520214-S440	1	115	Ford Dealer
Bolt, M12x75	HM14AU70-5C	1	132	ARP
Nut, M12	AUN12-3	1	132	ARP
Washer, M12	AUW876	1		ARP
Upper Control Arm LH	FR3Z-5500-D	1		Ford Dealer
Bolt / Washer, M12x104	W716795-S439	1	115	Ford Dealer
Nut, M12 (to Subframe)	W520214-S440	1	115	Ford Dealer
Bolt, M12x75	HM14AU70-5C	1	132	ARP
Nut, M12	AUN12-3	1	132	ARP
Washer, M12	AUW876	1		ARP
Vertical Link (Knuckle to Lower Control Arm)	PR3Z-5A972-A	2		Ford Dealer
Bolt, M14x82	W716342-S439	2	175	Ford Dealer
Bolt / Washer, M12x104 (to Knuckle)	W716795-S439	2	103	Ford Dealer
Nut / Ret, M12 (to Knuckle)	W715682-S900	2	103	Ford Dealer
Knuckle / Bearing Assembly RH, Modification	CM-5B758-S650	1		Watson
Knuckle Assembly RH	PR3Z-5B758-B	1		Ford Dealer
Bolt, M16x112 (to Lower Control Arm)	W717821-S439	1	275	Ford Dealer
Bearing (Toe Link Kit with 2 bearings)	M-5A460-M	1		Ford Performance Parts
Knuckle / Bearing Assembly LH, Modification	CM-5B759-S650	1		Watson
Knuckle Assembly LH	PR3Z-5B759-B	1		Ford Dealer
Bolt, M16x112 (to Lower Control Arm)	W717821-S439	1	275	Ford Dealer
Hub / Bearing Assembly	FR3Z-1104-G	2		Ford Dealer
Bolt, M12x58 (to Knuckle)	W718188-S439	8	115	Ford Dealer
Wheel Stud & Nut Kit	M-1107-E	1		Ford Performance Parts
Stud, M14x54	10-0042	10		Kimball Midwest
Nut, M14	40-0001-B	10	122	Kimball Midwest
Rear Upper Shock Mount	DHR-RUPRSHKMOUNT	2		Watson
PIA, Bushing	N/A	4		Watson
Bolt, M12x35 (Mount to Body)	W718383-S439	4	103	Ford Dealer
Washer	37-3907	4		Kimball Midwest

# Bill of Materials (Cont.)

Part Description	Part Number	Qty	Torque Nm	Supplier
<b>Rear Suspension (Cont.)</b>				
Lower Shock Mount, Top	LCR-LSBRKT-DH	2		Capaldi Racing
Washer	37-3907	4		Kimball Midwest
Lower Shock Mount Assembly, Bottom	DHR-RLOWERSHKMNT	2		Watson
Bolt, 3/8-24x2-1/2"	39-0620	2	61	Kimball Midwest
Lock Nut, 3/8-24	348506	2	61	Kimball Midwest
Lock Nut, 7/16-20	348507	2	81	Kimball Midwest
Flat Washer, 3/8 SAE Grade 8	373906	4		Kimball Midwest
Flat Washer, 7/16 SAE Grade 8	373907	4		Kimball Midwest
Bolt, 7/16-20x2-1/2 SAE Grade 8	390716	2	81	Kimball Midwest
Spacer, Diameter 0.75"x0.625"	N/A	2		Watson
Spacer, Diameter 0.625"x0.125"	N/A	2		Watson
Toe Link Assembly Kit (Adjustable)	DHR-TOE-LINK-ASSY	2		Watson
Nut, M14	W520215-S440	4	103	Ford Dealer
Bolt, M14x94	W704888-S900	2	175	Ford Dealer
Bolt, M14x77	W711504-S439	2	175	Ford Dealer
Spacer, Subframe Side	N/A	4		Watson
Anti Roll Bar, Rear	FR3Z-5A772-E	1		Ford Dealer
Bushing for Anti Roll Bar, Rear	F2GZ-5493-C	2		Ford Dealer
Clamp (Anti-Roll Bar to Subframe)	DG9Z-5B484-A	2		Ford Dealer
Bolt, M10x25 (Clamp to Subframe)	W711918-S439	4	70	Ford Dealer
Adjustable Rear Drop Link, Anti Roll Bar	LCR-DH-RSBL	2		Capaldi Racing
Bracket (Brake Line to Anti Roll Bar) RH	PR3Z-2082-B	1		Ford Dealer
Bracket (Brake Line to Anti Roll Bar) LH	PR3Z-2082-A	1		Ford Dealer
Nut, M12 (Link To Anti Roll Bar/Lower Control Arm)	W520214-S440	4	60	Ford Dealer
Rear ARB Hardware Kit	DHR-RSWYBRHRDWR	1		Watson
Hex Bolt, M12-1.75x60, Modified	N/A	2	60	Kimball Midwest
Hex Bolt, M12-1.75x50, Modified	N/A	2	60	Kimball Midwest
Sleeve, 5/8 Dia x 1/2 Stock	N/A	2		N/A
Sleeve 5/8 Dia x 3/8 STK	N/A	2		N/A
Spring, Rear	186C1000	2		HRP
Spring Bearing Kit, Rear (2")	GEN-GC1017	2		HRP
<b>Driveline System</b>				
Sealed Differential	FP-4001-DHR	1		Watson
Service Differential				Drivetrain Specialists (DTS)
Bolt / Washer, M14x75 (Diff to Subframe)	W716983-S439	2	175	Ford Dealer
Bolt, M14x90 (Diff to Subframe)	W716979-S439	2	175	Ford Dealer
Barbed Fitting (for Diff Vent)	2L1Z-4022-BA	1		Ford Dealer
Transmission / Differential Vent, Modification	N/A	1		Watson
Transmission Vent	MR3Z-7A246-B	2		Ford Dealer
P-Clamp, 1/2"	26-464	1		Kimball Midwest
Fuel Hose (5/16") 3 1/2' in Length (Diff)	H176	1		NAPA
Connector, 5/16" Vacuum	5372K515	1		McMaster Carr
P-Clamp, 1/2"	26-464	1		Kimball Midwest
Grommet, 5/8" ID	26-822	1		Kimball Midwest
Oetiker Clamp, 14.5mm	16700013	1		Grainger
Bolt, M6x20 (Attach P-Clamp and Vent to Body)	W505255-S450L	1	12	Ford Dealer
Differential Temperature Sensor	9L8Z-6G004-E	1		Ford Dealer
Half shaft, Modification	N/A	2		Watson
Axle Shaft RH	KR3Z-4K138-D	1		Ford Dealer
Axle Shaft LH	KR3Z-4K139-G	1		Ford Dealer

# Bill of Materials (Cont.)

Part Description	Part Number	Qty	Torque Nm	Supplier
<b>Driveline System (Cont.)</b>				
Half Shaft, Modification (Cont.)				
Nut, M22 (Shaft to Hub)	CCPZ-3B477-G	2	115+30°	Ford Dealer
Reddy Straw, 1"	3030N1	2		McMaster Carr
Cable Tie, 3/16"	26-581	2		Kimball Midwest
Transmission Cooler w/ Top Bracket	PR3Z-6A642-A	1		Ford Dealer
Bracket (Lower Mounting of Cooler)	FR3Z-6K743-A	1		Ford Dealer
Bolt, M6x25	W721571-S442	2	10	Ford Dealer
Bolt, M8x45 (Upper Bracket)	W714182-S442	1	22	Ford Dealer
Bolt, M8x22	W503293-S439	1	22	Ford Dealer
Bolt, M8x27	W709390-S439	1	22	Ford Dealer
Clip, M8 (Bracket to K member)	W709990-S439	1	22	Ford Dealer
Bolt, M8x30	W711137-S442	2	22	Ford Dealer
Sealed Transmission	FP-7003-DHR	1		Technosports
Service Transmission				Hanlon Motorsports
Stud, M10x60+M6x16	W719349-S439	3	47.5	Ford Dealer
Bolt, M10x60	W714289-S437	2	47.5	Ford Dealer
Stud, M10x75+M6x12	W718165-S439	1	47.5	Ford Dealer
Stud, M10x80+M6x12	W714416-S437	1	47.5	Ford Dealer
Plate (Between Engine Block and Bell Housing)	JL3Z-7007-C	1		Ford Dealer
Shifter, Modification	N/A	1		Watson
Shifter	MR3Z-7210-A	1		Ford Dealer
Bolt / Washer, M10x65 (To Trans)	W715200-S437	1	40	Ford Dealer
Bolt, M8-1.25x25 (to Interlink)	4R3Z-7C211-AA	1	15	Ford Dealer
Nut, M6 (Shifter to Body)	W520101-S450	2	10.5	Ford Dealer
Boot	N/A	1		Ford Dealer
Shifter Kit	LCR-7210-A	1		Capaldi Racing
Handle	N/A	1		Capaldi Racing
Reverse Lock Out	N/A	1		Capaldi Racing
Shift Knob	N/A	1		Capaldi Racing
Clutch Assembly	JR3Z-7B546-A	1		Ford Dealer
Bolt, M8x25	W717330-S439	6	35	Ford Dealer
Clutch Line, Stainless Steel	S650-DHR-CLUTCH-LINE	1		Watson
Clutch Master Feed Kit	LCR-CMFK-DH	1		Capaldi Racing
Tube, 90deg (Trans to Clutch Line)	7R3Z-7K505-A	1		Ford Dealer
Transmission Mount Assembly	N/A	1		Ford Dealer
Isolator	BR3Z-7E373-B	1		Ford Dealer
Cross Member	BR3Z-6A023-B	1		Ford Dealer
Bolt / Washer, M12x54	W720138-S439	4	62.5	Ford Dealer
Bolt, M12x75	W715936-S437	3	103	Ford Dealer
Transmission Cooler Lines Kit	DHR-TRANS-CLR-LINES	1		Watson
Line (From Trans), Modification	N/A	1		Watson
Line (From Trans)	PR3Z-7R081-F	1		Ford Dealer
PIA, Transmission In	N/A	1		Watson
PIA, Transmission Out	N/A	1		Watson
Line (From Engine Oil Cooler), Modification	N/A	1		Watson
Line (Engine Oil Cooler)	PR3Z-6B850-A	1		Ford Dealer
Rivet Push Pin, 6.5x4.5	W714040-S300	1		Ford Dealer
P-Clamp, 1/2"	26-464	4		Kimball Midwest
Bolt, M6x16	W505253-S439	4	10	Ford Dealer
Bolt, M6x15	W721914-S450	2	10	Ford Dealer

# Bill of Materials (Cont.)

Part Description	Part Number	Qty	Torque Nm	Supplier
<b>Driveline System (Cont.)</b>				
Transmission Cooler Lines Kit (Cont.)				
Nut / Washer, M6	W720631-S442	1	10	Ford Dealer
Nut / Washer, M10	W520125-S442	2	47.5	Ford Dealer
Stud Bolt, M10x24.5+M6x16.5 (Trans Line to Plate)	W721594-S437	2	35	Ford Dealer
Zip Tie (AN Lines to K Member)	26-684	6		Kimball Midwest
Bolt, M6 (AN Lines to K Member)	45-20616	2	10	Kimball Midwest
P-Clamp (AN Lines to K Member)	26-466	4		Kimball Midwest
Drive Shaft	PR3Z-4R602-G	1		Ford Dealer
PIA, Bolt (Shaft to Diff)	N/A	6	62.5	Ford Dealer
Bolt, M12x27 (Shaft to Trans)	N800594-S101	4	110	Ford Dealer
Bolt, M10x19 (Center Bearing to Body)	W717822-S439	2	47.5	Ford Dealer
Front Drive Shaft Loop Kit	CM-5478-MGTF	1		Watson
Loop, U Bracket	N/A	1		Watson
Bottom Plate	N/A	1		Watson
Weld Stud Plate	N/A	2		Watson
Bolts, M8-1.25x35	N/A	4	22	Watson
Nylon Nuts, M8-1.25	N/A	8	22	Watson
Square Washers 5/16"	N/A	2		McMaster Carr
Rear Drive Shaft Loop Kit	CM-5478-350S-R	1		Watson
PIA, Loop	N/A	1		Watson
PIA, Cross Bar	N/A	1		Watson
Weld Stud Plate	N/A	2		N/A
Bolts, M8-1.25x35	N/A	4	22	Kimball Midwest
Nylock Nut, M8-1.25	N/A	8	22	Kimball Midwest
Wiring Modification to Differential Pump	WMOD-GEN_GC1111	1		Watson
Differential Pump (Genesis)	GEN_GC1111	1		HRP
X-Tree Zip Tie	T-50RTM	2		Kimball Midwest
Fitting, Male -8 AN to 3/8" Male Pipe (Diff Pump)	FBM5007	2		HRP
Bolt, M8 (Pump to Bracket)	4653286	4	22	Kimball Midwest
Bolt, M8 (Pump Bracket to Rear Subframe)	4653286	2	22	Kimball Midwest
Bracket (Diff Pump to Body)	DHR-DIFFPMPBRKT-AS	1		Watson
Wiring Modification to Differential Cooler and Fan Unit	WMOD-SETFP920M22I	2		Watson
Differential Cooler and Fan Unit	SETFP920M22I	2		HRP
Zip Tie	26-681	2		Kimball Midwest
Bracket, Differential Cooler and Fan Unit	DHR-DIFF-CLR-BRKT	2		Watson
Fitting, Setrab M22-AN08 Adapter (Differential Coolers)	SET22-M22AN08-SE	4		HRP
Differential Cooler Line Kit	DHR-DIFF-CLR-LINES	1		Watson
LH Cooler Out / Differential In	N/A	1		Watson
Pump Out / RH Cooler In	N/A	1		Watson
Differential to Pump In	N/A	1		Watson
RH Cooler Out / LH Cooler In	N/A	1		Watson
Filter Screen for Differential Cooler	SET11-UF08	1		HRP
Isolator for Differential Cooler	2008MM10-60	8		AV Industrial
<b>Steering System</b>				
Steering Column	PR3Z-3C529-A	1		Ford Dealer
Nut, M8	W520102-S437	4	25	Ford Dealer
Steering Shaft w/ Bearing	PR3Z-3E751-A	1		Ford Dealer
Bolt, M8x31 (Shaft to Column)	W714878-S450	2	30	Ford Dealer
Nut / Washer, M6 (Bearing to Firewall)	W707137-S437	2	9	Ford Dealer

# Bill of Materials (Cont.)

Part Description	Part Number	Qty	Torque Nm	Supplier
<b>Steering System (Cont.)</b>				
Multifunction Switch, Modification	DHR-CLMNSWTCH-MOD	1		Watson
Multifunction Switch	PR3Z-3F791-BA	1		Ford Dealer
Screw, M5x25	W504698-S451	4	2.8	Ford Dealer
Steering Shaft (Lower)	FR3Z-3B676-B	1		Ford Dealer
Yoke (Lower Shaft to Rack)	FR3Z-3N725-B	1		Ford Dealer
Bolt, M8x31 (Shaft to Yoke, Yoke to Rack)	W714878-S450	2	30	Ford Dealer
Programmed EPAS	FP-3D070-DHR	1		Watson
EPAS (Steering Rack)	N/A	1		Ford Dealer
Bolt / Washer, M16x79 (EPAS)	W717106-S439	2	200	Ford Dealer
Steering Hub	01502067CA	1		Sparco SPA
Bolt / Washer, M10x37 (Hub to Column)	W721079-S437	1	62.5	Ford Dealer
Quick Release w/ Hardware (Steering Wheel to Hub)	015R98TU	1		Sparco SPA
Bolt, M5-0.80x20	4653455	6	2.8	Kimball Midwest
Nut, M5	46-5505	6	2.8	Kimball Midwest
Steering Wheel	M-3600-RA	1		Ford Performance Parts
Steering Wheel Hook	JOES-10704-B	1		HRP
Steering Wheel Switch Plate	DHR-STRNGWHLSWTCH	1		Watson
<b>Brake System</b>				
<b>Anti-Lock Brake System (ABS)</b>				
Dark Horse R ABS M5 Clubsport Kit				
PIA, ABS Module (500kbaud/DF11S)	FP-2353-DHR	1		Technosports
PIA, Pressure Sensor	F02U.V05.287-01	1		Technosports
PIA, Yaw / Acceleration Sensor	0261.008.022	2		Technosports
PIA, Yaw / Acceleration Sensor	F02U.V02.589-01	1		Technosports
Bolt, M10-1.0 (Sensor to Bracket)	241958	2	50	Kimball Midwest
PIA, Mounting Plate, Yaw Sensor	1271.032.390	1		Technosports
Bolt, M6x16 (Bracket to Frame)	45-20616	2	10	Kimball Midwest
PIA, 12 Position Switch	F02U.V03.390-01	1		Technosports
PIA, ABS M5 Scale, Standard	F02U.004.709-01	1		Technosports
MSA Box, Signal Converter	F02U.V00.327-03	1		Technosports
ABS Bracket	DHR-ABSBKRT-AS	1		Watson
Nylock Nut, M6-1.0	46-5506	4	10	Kimball Midwest
Isolator (Male/Male Bobbin)	2008MM10-60	4		AV Industrial
<b>Front Brakes</b>				
Brake Kit, Front				
Caliper RH	7K2.9005AK	1		Race Technologies
Caliper LH	XB8GK52	1		Race Technologies
Caliper LH	XB8GK51	1		Race Technologies
Bracket, Caliper	20B71805	2		Race Technologies
Studs, Bracket to Caliper	80080C	4		Race Technologies
Washer, Bracket to Caliper	WS-7	4		Race Technologies
Nuts, Bracket to Caliper	MS-7	4	92	Race Technologies
Disc RH	759B97946	1		Race Technologies
Disc LH	759B97936	1		Race Technologies
Bell	16B71452	2		Race Technologies
Bolts, Bell	05582916	42	7	Race Technologies
Ring, Bell	05A46739	2		Race Technologies
Front Brake Pad Kit	BRP34-1980WA.29B	1		Race Technologies
Bolt, M12x38 (Caliper Bracket to Knuckle)	W721714-S439	4	110	Ford Dealer
ABS Wire Front RH (S550)	JR3Z-2C205-A	1		Ford Dealer
ABS Wire Front LH (S550)	JR3Z-2C204-A	1		Ford Dealer
Bolt, M6x12	W500011-S442	2	9	Ford Dealer

# Bill of Materials (Cont.)

Part Description	Part Number	Qty	Torque Nm	Supplier
<b>Front Brakes (Cont.)</b>				
ABS Wire Bracket RH, Front, Modified	PR3Z-2C224-B	1		Ford Dealer
ABS Wire Bracket LH, Front, Modified	PR3Z-2C224-A	1		Ford Dealer
Rivet, 6.6x23.9	W707874-S417	2		Ford Dealer
Bolt (ABS Wire Bracket to Damper)	W505924-S442	2	110	Ford Dealer
Hose Assembly, Front RH (Donor Part)	PR3Z-2078-D	1		Ford Dealer
Hose Assembly, Front LH (Donor Part)	PR3Z-2078-C	1		Ford Dealer
Screw, M8x20 (Front Hose)	W505263-S439	2	27.5	Ford Dealer
Screw, M8x20 (Rear Hose)	W505263-S439	4	35	Ford Dealer
Bolt, M8x20 (Front Hose)	W714824-S439	2	30	Ford Dealer
Screw, M8x20 (Rear Hose)	W713315-S442	2	27.5	Ford Dealer
Copper Washer for Brake Lines, 10.2x15x1.2	W711784-S300	4		Ford Dealer
Booster	FR3Z-2005-G	1		Ford Dealer
Master Cylinder	FR3Z-2140-C	1		Ford Dealer
Nut, M8 (Master to Booster)	W520212-S440	2	22.5	Ford Dealer
Cap, Master Cylinder	BV6Z-2162-A	1		Ford Dealer
Bushing, Booster to Pedal Box	3M5Z-2L523-AA	1		Ford Dealer
Vacuum Hose, Modified	FR3Z-2420-K	1		Ford Dealer
Hose, 5/8"	NBH H183	2in		NAPA
Fitting, 90deg Elbow	NBH-9924	1		NAPA
Nut / Washer, M6	W710771-S442	2	10	Ford Dealer
Oetiker Clamp, 25.6mm	16700031	3		Grainger
Brake Line Bracket Kit	DHR-FRTBRKLINE-BRKT	1		Watson
Front Brake Line Bracket LH	N/A	1		Watson
Front Brake line Bracket RH	N/A	1		Watson
Bolt, M6	45-20616	2	10	Kimball Midwest
Rivnut, M6	46-5506	2		Kimball Midwest
P-Clamp, 1/4"	26-461	2		Kimball Midwest
Front Brake Backing Plate Kit	WR-BRK-BCK-DHR	1		Watson
Front Brake Backing Plate RH	N/A	1		Watson
Front Brake Backing Plate LH	N/A	1		Watson
Bolt, M8x16	N/A	6	22	Kimball Midwest
<b>Rear Brakes</b>				
ABS Wire (Rear)	PR3Z-2C190-A	2		Ford Dealer
Bolt, M6x16	W505253-S450L	2	10	Ford Dealer
Caliper Rear RH	PR3Z-2552-B	1		Ford Dealer
Caliper Rear LH	PR3Z-2553-B	1		Ford Dealer
Bolt, M12x100	W722051-S439	4	133	Ford Dealer
Rear Brake Disc	PR3Z-2C026-A	2		Ford Dealer
Rear Brake Pad Kit	P1309.17.F01	1		Race Technologies
Caliper Banjo Bolt, M10x1	BJB-03-2-7-S-W	2	24.5	BMRS
Copper Washer for Brake Lines, 10.2x15x1.2	W711784-S300	4		Ford Dealer
Rear Brake Line RH, Modified (Donor Part for Brackets)	PR3Z-2282-B	1		Ford Dealer
Rear Brake Line LH, Modified (Donor Part for Brackets)	PR3Z-2282-D	1		Ford Dealer
Rear Brake Line Spacer Kit	WR-BRK-SPCR	2		Watson
Rear Brake Line Spacer 1, 0.290 line	N/A	4		Watson
PIA, Spacer 1	N/A	2		Watson
P-Clamp	N/A	1		Kimball Midwest
Rear Brake Line Spacer 2, 0.187 line	N/A	2		Watson
PIA, Spacer 2	N/A	2		Watson
P-Clamp	N/A	1		Kimball Midwest

# Bill of Materials (Cont.)

Part Description	Part Number	Qty	Torque Nm	Supplier
<b>Brake Lines</b>				-
Stainless Steel Brake Line Kit	DHR-SSBRAKELINEKIT	1		Watson
Master to ABS (Front)	N/A	1		Watson
Bosch PST-F1 Sensor-NPT 1/8" Male Adapter	N/A	1		Fore Innovations
Female Branch Tee-S316, 1/4x1/8"	N/A	1		Michigan Valve & Fitting Inc
Master to ABS (Rear)	N/A	1		Watson
Bosch PST-F1 Sensor-NPT 1/8" Male Adapter	N/A	1		Fore Innovations
Female Branch Tee-S316, 1/4x1/8"	N/A	1		Michigan Valve & Fitting Inc
ABS to Front RH	N/A	1		Watson
ABS to Front LH	N/A	1		Watson
ABS to Rear RH	N/A	1		Watson
ABS to Rear LH	N/A	1		Watson
P-Clamp, 1/4"	26-461	2		Kimball Midwest
Bolt, M6x16	45-20616	2	10	Kimball Midwest
Flexible Brake Line Kit	DHR-FLEX-BRK-LINES	1		Watson
Brake Line Front RH / LH	N/A	2		BMRS
Brake Line Rear RH	N/A	1		BMRS
Brake Line Rear LH	N/A	1		BMRS
P-Clamp, 1/4"	26-461	2		Kimball Midwest
Bolt, M6x14	W500212-S450	2	10	Ford Dealer
Nut, M6	W520201-S450B	2	10	Ford Dealer
Caliper Banjo Bolt, M10x1	BJB-03-2-7-S-W	2	24.5	BMRS
Rear Brake Line Bundle	PR3Z-9J279-A	1		Ford Dealer
Screw / Washer, M6x28	W712198-S439	1	9	Ford Dealer
<b>Pedals</b>				-
Pedal Box Assembly (Brake & Clutch) S550	FR3Z-2455-Z	1		Ford Dealer
Bolt / Washer, M8x31 (Pedal Box Assembly to Body)	W707108-S439	4	22.5	Ford Dealer
Nut, M8 (Booster to Pedal Box Assembly)	W520212-S440	6	22.5	Ford Dealer
Donor Part for Clutch Master, Pedal Box S650	PR3Z-2455-E	1		Ford Dealer
Brake Pedal Switch	GLRZ-13480-A	1		Ford Dealer
Gas Pedal	CR3Z-9F836-H	1		Ford Dealer
Nut, M6 (Pedal to Body)	W711330-S442	3	9	Ford Dealer
Switch (Lower Clutch)	PR3Z-11A152-A	1		Ford Dealer
<b>Wheel &amp; Tire Assembly</b>				-
Center Cap	FR3Z-1130-D	4		Ford Dealer
Wheel (19x10.5) (Front)	M-1007-SR1MB19X105F	2		Ford Performance Parts
Wheel (19x11) (Rear)	M-1007-SR1MB19X11R	2		Ford Performance Parts
Pirelli Pzero 305/30 ZR19 (Front)	N/A	2		Ford Dealer
Pirelli Pzero 315/30 ZR19 (Rear)	N/A	2		Ford Dealer
Valve Stem	90-414	4		NAPA
<b>Information, Programing, Gauge &amp; Warning System</b>				-
Data System, MC187	M C187 Dark Horse R	1		MoTeC USA
Data System GPS Antenna	M GPS-L10	1		MoTeC USA
Grommet, 5/8" ID (Installed on Roof)	26-822	1		Kimball Midwest
Zip Tie	26-684	7		Kimball Midwest
X-Tree Zip Tie	T-50RTM	2		Kimball Midwest
Bracket (Mount Screen to Clock Spring)	DHR-MOTECBRKT	1		Watson
Weld Nut, M4	93337A500	2	2.2	McMaster Carr
Washer, M5	45-3505	3		Kimball Midwest
Nylock Nut, M5x0.8	46-5505	3	2.8	Kimball Midwest
Screw, M4-1.0x10	46-3266	2	2.2	Kimball Midwest
ProCal 4	M-12655-F	1		Ford Performance Parts
Ambient Temperature Sensor	FR3Z-12A647-B	1		Ford Dealer

# Bill of Materials (Cont.)

Part Description	Part Number	Qty	Torque Nm	Supplier
<b>Information, Programing, Gauge &amp; Warning System (Cont.)</b>				
Oil Temperature Sensor	M 25-2197D	1		MoTeC USA
Transmission Temperature Sensor	M 25-2197D	1		MoTeC USA
X-Tree Zip Tie	T-50RTM	1		Kimball Midwest
Transponder Bracket Assembly	DHR-LAPSBKRT	1		Watson
Bolt, M6x16 (Bracket to Body)	4520616	2	10	Kimball Midwest
Bolt, M4x10 (Transponder to Bracket)	2759802	2	2.2	Kimball Midwest
Rivnut, M4	85411	2		Kimball Midwest
<b>Electrical</b>				
Battery	BAGM-48H6-760	1		Ford Dealer
Battery Vent Tube	R1MZ-10A818-B	1		Ford Dealer
Battery Harness, Modification	PR3T-14B060-PEMOD	1		Technosports
Battery Harness	PR3Z-14300-PA	1		Ford Dealer
Battery to Breaker Cable	FP-14B060-AA	1		Technosports
Breaker to Relay Cable	FP-14B060-BA	1		Technosports
P-Clamp, 3/4"	26466	1		Kimball Midwest
Nut / Washer, M6 (to PDB)	W716298-S450	6	10.5	Ford Dealer
Screw, M6x20	W505424-S442	2	12	Ford Dealer
Nut, M6 Nylon Insert (to Body)	W520201-S440	1	12	Ford Dealer
Fuse Panel (PDB)	PR3Z-14A068-B	1		Ford Dealer
Fuse Panel Cover	PR3Z-14A003-A	1		Ford Dealer
Fuse Panel Mounting Bracket	PR3Z-14A254-C	1		Ford Dealer
Bolt / Washer, M6x25	W711158-S442	1	10	Ford Dealer
PDB Harness, Modification	M40724 01-1	1		PRS
PDB Harness	PR3Z-14290-HA	1		Ford Dealer
Bolt, M6	45-20616	2	10	Kimball Midwest
Zip Tie	26-684	2		Kimball Midwest
Bolt / Ret, M6x20	W710381-S439	1	10	Ford Dealer
Ground Bolt, M6x20	W505255-S450L	9	12	Ford Dealer
CAN Jumper Harness (Underhood)	FP-14290-BA	1		Technosports
Zip Tie	26-684	10		Kimball Midwest
P-Clamp, 3/8"	26-463	1		Kimball Midwest
CAN Jumper Harness (IP)	FP-14401-DA	1		Technosports
Ground Bolt, M6x20	W505255-S450L	1	12	Ford Dealer
Front Loom	M40721 01-1	1		PRS
Cap Connector	FR3Z-14A666-A	1		Ford Dealer
Main Breaker	CB3-SM-300	1		Technosports
Socket Head Cap Screw, M6-1.0x20	46-50620	2	10	Kimball Midwest
Bolt, M6x20	W705968-S439	1	10	Ford Dealer
Relay	29-311-11A	1		Technosports
Socket Head Cap Screw, M6-1.0x20 (Relay)	46-50620	2	10	Kimball Midwest
Zip Tie	26-684	1		Kimball Midwest
Body Harness, Modification (Overlay)	PR3T-14A005-ZEMOD	1		Technosports
Body Wiring Harness Assembly	PR3Z-14A005-ZA	1		Ford Dealer
Screw / Washer, M6x20	W716914-S439	4	9	Ford Dealer
Zip Tie	26-684	25		Kimball Midwest
Ground Bolt, M6x16 (Trunk)	W505253-S450L	2	12	Ford Dealer
Ground Bolt, M6x16 (B-Pillar)	W505253-S450L	2	12	Ford Dealer
Ground Bolt, M6x16 (Lower Foot Well)	W505253-S450L	2	12	Ford Dealer
Rivet	PR43-SSP	4		Reid
X-Tree Zip Tie	T-50-RTM	2		Terminal Supply Co.
Grommet, 5/8" ID	26-822	4		Kimball Midwest



# Bill of Materials (Cont.)

Part Description	Part Number	Qty	Torque Nm	Supplier
<b>Electrical (Cont.)</b>				
Cockpit Loom	M40720 01-1	1		PRS
Zip Tie	26-684	3		Kimball Midwest
Ground Bolt, M6x16	W505253-S450L	1	12	Ford Dealer
P-Clamp, 3/8"	26-463	1		Kimball Midwest
IP (Dash) Harness, Modification	PR3T-14401-EEMOD	1		Technosports
Main Wiring Harness	PR3Z-14401-EA	1		Ford Dealer
Ground Bolt, M6x20	W505255-S450L	4	12	Ford Dealer
Zip Tie	26-684	25		Kimball Midwest
X-Tree Zip Tie	T-50-RTM	2		Terminal Supply Co.
PTT Jumper Harness	FP-14401-AA	1		Technosports
Zip Tie	26-684	5		Kimball Midwest
HS2-CAN Jumper	M40732 01-1	1		PRS
Alternator Assembly	PR3Z-10346-B	1		Ford Dealer
Stud, M10x19.8+M10x33.3	W712609-S437	1	8	Ford Dealer
Nut, M10	W520414-S442	1	47.5	Ford Dealer
Bolt / Washer, M10x92	W715092-S437	1	47.5	Ford Dealer
Nut / Washer, M8	W711953-S900	1	17.5	Ford Dealer
PCM	FP-12A650-DHR	1		Ford Dealer
Bolt, M6x25 (PCM to Bracket)	W500015-S442	2	10	Ford Dealer
Bracket (PCM to Body)	PR3Z-12A659-C	1		Ford Dealer
Bolt, M6x20 (PCM to Body)	W716914-S307	2	10	Ford Dealer
Nut Clip, M6	W710198-S439	1		Ford Dealer
Bracket (PCM Support)	DHR-PCMBRKT-AS	1		Watson
Bolt, M6-1.0x16	45-20616	3	10	Kimball Midwest
P-Clamp	26-480	1		Kimball Midwest
Rivnut, M6-1.0	85413	2		Kimball Midwest
Wiring - Clutch Pedal Position	PR3Z-15K857-AA	1		Ford Dealer
Body Ancillary Module + Bracket	PR3Z-13C788-B	1		Ford Dealer
Body Control Module (BCM)	PR3Z-15604-B	1		Ford Dealer
Nut / Washer, M6	W702751-S442	1	8	Ford Dealer
Hegos (O2 Sensor), Black RH	PR3Z-9F472-A	1		Ford Dealer
Hegos (O2 Sensor), Gray LH	PR3Z-9F472-E	1		Ford Dealer
RH Door Harness, Modification	PR3T-14630-HFMOD	1		Technosports
RH Door Harness	PR3Z-14630-HA	1		Ford Dealer
LH Door Harness, Modification	PR3T-14631-KFMOD	1		Technosports
LH Door Harness	PR3Z-14631-KA	1		Ford Dealer
Zip Tie	26-684	2		Kimball Midwest
Differential Pump Jumper Harness	FP-14A411-AA	1		Technosports
Zip Tie	26-684	8		Kimball Midwest
Plug, 33.6-36x0.6	W711539-S300	1		Ford Dealer
Fuel Pump Jumper Harness	FP-2B572-AA	1		Technosports
Zip Tie	26-684	14		Kimball Midwest
P-Clamp	26-466	2		Kimball Midwest
P-Clamp, 3/8"	26-463	2		Kimball Midwest
Ground Bolt, M6x16	W505253-S450L	1	12	Ford Dealer
Nut, M6	W711330-S442	1	12	Ford Dealer
Differential Temp / Rear Chassis Harness, Modification	PR3T-2B572-FEMOD	1		Watson
Differential Temp / Rear LH Chassis Harness	PR3Z-2C011-E	1		Ford Dealer
Zip Tie	26-464	2		Kimball Midwest

# Bill of Materials (Cont.)

Part Description	Part Number	Qty	Torque Nm	Supplier
<b>Electrical (Cont.)</b>				
Gateway Module	PU5Z-14G490-J	1		Ford Dealer
Bolt / Washer, M6x20	W716914-S307	4	10	Ford Dealer
Nut, M6	W520101-S437	3	10	Ford Dealer
Ground Strap	PR3Z-19A095-B	1		Ford Dealer
Nut, PIA	W715955-S900	1	10.5	Ford Dealer
Nut, PIA	W718941-S900	1	10.5	Ford Dealer
Bolt, M6x14	W500212-S450	1	13.5	Ford Dealer
Park Aid Sensor	JU5Z-15K859-APTM	4		Ford Dealer
Can Bridge Module	M-14660-2FD	1		Technosports
Can Bridge Flash	FP-CANBRIDGEv1.0-DHR	1		N/A
3M Dual Lock Velcro, 3in	SJ3550CFBK1"X50YD-ND	4		3M
Interior Master Power Panel	DHR-MSTR-PWR-PNL	1		Watson
Rivet, 1/8"	PR4Z-SSP	2		Kimball Midwest
Exterior Power Panel (Master Power / Fire Switch)	DHR-EXTRPWRPNL	1		Watson
Rivet	MARSABL6-6	2		Metro Bolt & Fastener
Grommet, 5/8" ID	26-822	2		Kimball Midwest
Center stack Switch Panel	DHR-CENTERSTACK	1		Watson
Screw, M6-1.0x20	92095A240	4	10	McMaster Carr
Rivnut, M6-1.0	85413	2		Kimball Midwest
Zip Tie	26-684	12		Kimball Midwest
Center Switch Panel Harness, Lower	M40730 01-1	1		PRS
OBD2 Mounting Plate	DHR-OBD2-MNT-PLT	1		Watson
Rivnut, M6-1.0	85413	3		Kimball Midwest
Button Head Screw, M6-1.0x30	2729796	3	10	Kimball Midwest
Button Head Screw, M3-0.50x15	91290A572	3	1	McMaster Carr
Nut, M3x0.50	46-3503	3	1	Kimball Midwest
Headlight Assembly RH, Modification	FP-13005-DHR	1		Technosports
Headlight Assembly RH	N/A	1		Ford Dealer
Bolt / Washer, M6x18	W720434-S450B	1	8	Ford Dealer
Bolt / Washer, M6x32	W722695-S439	2	3.2	Ford Dealer
Headlight Assembly LH, Modification	FP-13006-DHR	1		Technosports
Headlight Assembly LH	N/A	1		Ford Dealer
Bolt / Washer, M6x18	W720434-S450B	1	8	Ford Dealer
Bolt / Washer, M6x32	W722695-S439	2	3.2	Ford Dealer
Fuel Pump Driver	PR3Z-13404-B	1		Ford Dealer
Nut / Washer, M6	W710771-S442	3	6.2	Ford Dealer
Tail Light Assembly LH	PR3Z-13405-B	1		Ford Dealer
Nut / Washer, M6	W710771-S442	3	6.2	Ford Dealer
Trim (Top of Tail Light) RH	PR3Z-13420-A	1		Ford Dealer
Trim (Top of Tail Light) LH	PR3Z-13420-B	1		Ford Dealer
3rd Brake Light Assembly	DS7Z-13A613-C	1		Ford Dealer
Nut, M5	W520100-S437	4	4.1	Ford Dealer
Zip Tie	26-684	5		Kimball Midwest
Headlamp Position Control Module	NL1Z-13K198-S	1		Ford Dealer
Bolt, 4.2x25	W713306-S424	2		Ford Dealer
Headlamp Switch / Bezel	PR3Z-11654-AA	1		Ford Dealer
Rear Lamp Assembly RH	PR3Z-15A201-A	1		Ford Dealer
Rear Lamp Assembly LH	PR3Z-15A201-C	1		Ford Dealer

# Bill of Materials (Cont.)

Part Description	Part Number	Qty	Torque Nm	Supplier
<b>Electrical (Cont.)</b>				
Fuel Pump Driver	PR3Z-9D370-A	1		Ford Dealer
Nut, M6	W705460-S437	1	10	Ford Dealer
Bolt / Washer, M6x35	W711973-S439	1	10	Ford Dealer
Steering Wheel Switch Plate Harness	M40731 01-1	1		PRS
<b>Recommended Fluids</b>				
-				
Gear Lube (Motorcraft 75W-85), 1 quart	XY-75W85-QL	4		Ford Dealer
Transmission Fluid (Motorcraft Mercon LV), 1 quart	XT-10-QLVC	4		Ford Dealer
Oil (Motorcraft 5W-50), 1 quart	XO-5W50-QGT	15		Ford Dealer
Paint	PMPC-19500-5920A	N/A		Ford Dealer
Brake Fluid, Brembo HTC64	04816420	5		Race Technologies
Green Loctite	LOC1835205	0.2		HRP
Loctite Primer	LOC494147	0.1		HRP
Blue Loctite	TA-25B	1		Ford Dealer
Red Loctite	TA-26	1		Ford Dealer
Plastic Welder II	IT412	0.25		R.S. Hughes
<b>Safety Systems</b>				
-				
Driver Safety Harness	SAB-CFCI22100056	1		HRP
PIA, Eye Bolt, 7/16	N/A	3	40	HRP
Fender Washer, 7/16-2.51 OD	2.500-0.468-.3075S-Z	1		Global Fastener
Nut, 7/16 - 20	348507	3	40	Kimball Midwest
Safety Seat	071.38.0630-01	1		Recaro
PIA, Bolt (M20x20, Grade 10.9)	N/A	4	22	Recaro
Button Head Bolt, M8-1.25x25	2628989	4	35	Kimball Midwest
Bracket, Seat	7206293NA	1		Recaro
Button Head Bolt, M8-1.25x25 (Seat Bracket)	2628989	4	35	Kimball Midwest
Washer, M8 (Seat Bracket)	45-3508	4		Kimball Midwest
Fire Suppression System	014772MSL	1		Sparco SPA
PIA, Fire Bottle	N/A	1		Sparco SPA
PIA, Line Kit	N/A	1		Sparco SPA
PIA, Fire Bottle Mount	N/A	1		Sparco SPA
PIA, Pull Cable	N/A	2		Sparco SPA
PIA, Fittings	N/A	7		Sparco SPA
PIA, Spray Nozzles	N/A	5		Sparco SPA
Bolt, M6x16	W505253-S439	13	10	Ford Dealer
Flange Nut, M6	46-15006	1		Kimball Midwest
Grommet, 3/8" ID	26-814	1		Kimball Midwest
P-Clamp, 1/2"	26464	5		Kimball Midwest
P-Clamp, 3/8"	26463	5		Kimball Midwest
Window Net Rod Kit	DHR-NETHRDWR	1		Watson
Nylock Nut, 3/8-24	90101A245	1	40	McMaster Carr
Screw, 3/8x1.0x24	91306A297	1	40	McMaster Carr
Driver Window Net	LCR-DH-LHWN	1		Capaldi Racing
Helmet Support Net, Right Side (Ratchet Release)	SFC-8011-K-FIA	1		HRP
PIA, Net Assembly	N/A	1		HRP
PIA, Clip	N/A	3		HRP
Windshield Washer Tubing, 3.5"	H459	1		NAPA
Zip Tie	26-680	3		Kimball Midwest
Helmet Support Net, Left Side (Quick Release)	SFC-8111-K-L-FIA	1		HRP
PIA, Net Assembly	N/A	1		HRP
PIA, Clip	N/A	3		HRP
PIA, Jam Nut	N/A	1		HRP

# Bill of Materials (Cont.)

Part Description	Part Number	Qty	Torque Nm	Supplier
<b>Safety Systems (Cont.)</b>				
Roll Bar Padding Kit	DHR-ROLLBARPAD-MOD	1		Watson
Roll Bar Padding	BSCI-78001	1		HRP
PIA, A Pillar, 25in	N/A	1		HRP
PIA, A Pillar Support Upper, 9.5in	N/A	1		HRP
PIA, A Pillar Support Lower, 20.5in	N/A	1		HRP
PIA, Header, 10in	N/A	1		HRP
PIA, Roof Bar Forward, 23in	N/A	1		HRP
PIA, Door Bar Upper, 4in	N/A	1		HRP
PIA, Door Bar Lower, 7.5in	N/A	1		HRP
Zip Tie (28")	73125312	15		MSC
Ballast Kit	DHR WEIGHT BOX	1		Watson
Ballast Mount	200171-14-0000	1		Watson
Ballast Cover	20017-03-0182AA01	1		Technosports
Button Head Socket Cap, M10-1.5x20	4653291	2	35	Kimball Midwest
Flat Washer, M10	453510	2		Kimball Midwest
Button Head Socket Cap, M8-1.25x45	2628990	1	22	Kimball Midwest
Button Head Socket Cap, M8-1.25x	2628989	2	22	Kimball Midwest
Flange Nut, M8-1.25	4615008	2	22	Kimball Midwest
Flat Washer, M8	453508	3		Kimball Midwest
Ballast Plate, 2.5mm (Not Included)	20017-03-0062	2		Watson
Ballast Plate, 5mm (Not Included)	20017-03-0064	2		Watson
Ballast Plate, 10mm (Not Included)	20017-03-0066	2		Watson



# Change Log

Version#	Date	Summary of Changes
1	5.17.2024	
2	05.20.2024	<ul style="list-style-type: none"><li>• Made formatting changes and edited wording on General Notes.</li><li>• Added note about unrestricted fluids to the General Notes.</li><li>• Edited wording on Master Power Electrical Switch, Catch Can, Transponder Bracket, Relay, Door Foam, Safety Seat, Flexible Sidemount, Data System.</li><li>• Changed “Fluids” to “Recommended Fluids”.</li><li>• Updated picture of Exterior Power Panel and Rear Lower Arm LH/RH.</li><li>• Added picture of the sealed engine and fire suppression system nozzles, fittings and pull cable.</li><li>• Added tires (as delivered) to the BOM.</li><li>• Added Center Vents P/N to Interiors and ToC.</li><li>• Removed Ballast Plates from Interiors and edited Ballast in Appendix.</li><li>• Added “Not Included” to Ballast Plates in BOM.</li><li>• Updated ToC.</li><li>• Included a Version# / Date at bottom-right of page.</li></ul>
3	05.22.2024	<ul style="list-style-type: none"><li>• Added pictures of front camber adjusters to Dampers slide.</li><li>• Added pictures of the Camera System wiring and Ride Height Reference Points to the Appendix.</li><li>• Added “Not Included” to Ballast slide in Appendix.</li><li>• Updated ToC.</li><li>• Updated version name to Version#3 05.22.2024</li></ul>
4	06.05.2024	<ul style="list-style-type: none"><li>• Updated Grill Mesh (pg. 56-57); reference TSB #05.</li><li>• Added Engine Cooling Modifications to Appendix (pg. 60); reference TSB #03 for Radiator Closeout Modification and TSB #04 for Fan Shroud Modification.</li><li>• Updated Half Shaft nut (CCPZ-3B477-G) torque value in BOM (pg. 74).</li><li>• Updated Main Breaker and Relay part number in BOM (pg.79).</li><li>• Added Optional Shift Light Module (pg. 28).</li><li>• Added Optional Driver Cooling System Mount to Appendix (pg. 58-59).</li><li>• Updated ToC.</li><li>• Updated version name to Version#4 06.05.2024.</li></ul>
5	06.14.2024	<ul style="list-style-type: none"><li>• Added “Valve stem specification is open. Valve stem caps are required.” to General Notes (pg. 5).</li><li>• Added Air Jack System to Appendix (pg. 45-49).</li><li>• Added new required radiator and hose kit to Appendix (pg. 65).</li><li>• Added pictures of under hood, trunk, interiors and each wheel well for reference to Appendix (pg. 66-69).</li><li>• Updated ToC.</li><li>• Updated version name to Version#5 06.14.2024</li></ul>