

FORD **PERFORMANCE**

Mustang Dark Horse R Homologation



Table of Contents

General Notes	5	Trunk / Rear	13
Interior	6-9	Trunk Latch.....	13
Dash Panel.....	6	Rear Closeout.....	13
Dash Panel Closeout.....	6	Rear Fascia.....	13
Center Vents Assembly.....	6	Wing Wicker.....	13
Heat Shield.....	6	Engine	14-19
Dash Panel Top.....	6	Sealed Engine.....	14
Dead Pedal Kit.....	6	Engine Seal Locations.....	15
OBD2 Mounting Plate.....	6	Catch Can Kit.....	16
Rear View Mirror.....	7	Catch Can Bracket.....	16
Rear View Mirror Brackets.....	7	Oil Cooler Adapter.....	16
Optional 5" Rear View Mirror Brackets..	7	Oil Cooler Fitting Adapter Kit.....	16
Optional 9" Rear View Mirror Brackets..	7	Catch Can to Oil Pan Drain Back Hose.	16
Optional Side View Mirror.....	7	Oil Cooler.....	16
Optional Extended Side View Mirror Bracket.....	7	Heater Hose.....	17
Ballast Cover.....	7	Oil Cooler Lines.....	17
Ballast Mount w/ Hardware.....	7	Radiator.....	18
Ballast Plates.....	8	Lower Radiator Aluminum Hose.....	18
Ballast Assembly Location.....	8	Lower Radiator Soft Hoses.....	18
Door Foam – LH.....	9	Fan Shroud Modification.....	19
Door Latch Assembly – LH.....	9	Exhaust	20
Inner Door Panel – LH.....	9	Headers.....	20
Exterior	10	LH Collector Pipe.....	20
Tow Hook Kit – Rear.....	10	LH Tail Pipe.....	20
Hood Pins.....	10	X-Pipe.....	20
Tie Down Kit – Front / Rear.....	10	RH Collector Pipe.....	20
Battery Tray.....	10	RH Tail Pipe.....	20
Tow Hook Kit – Front.....	10	Exhaust Heat Wrap.....	21
Rear Deflector.....	10	Fuel	22-24
Exterior Power Panel (Master Power / Fire Suppression Pull Cable).....	10	Fuel Cell Spacer.....	22
Transponder Bracket.....	10	Fuel Cell Bladder Assembly.....	22
Front	11-12	Fuel Cell Lid.....	22
Front Fascia Assembly w/ Upper and Lower Grill Mesh.....	11	Fuel Pump Block Off Plate.....	22
Cowl Top Assembly.....	11	Fuel Line Fittings.....	23
Brake Duct Mounting Bracket.....	11	Fuel Lines.....	24
Brake Duct Hose Kit.....	11	Frame / Mounting	25
Radiator Closeout.....	11	Front Subframe (K Member).....	25
Brake Duct Inlets.....	11	Rear Subframe.....	25
Splitter Supports.....	12	Suspension	26-28
Splitter Pencil Rods.....	12	Bearing Kit for Control Arms - Front / Rear.....	26
Splitter Bumper Bracket.....	12	Front Lower Arm Assembly - LH.....	26
		Front Lower Arm Assembly - RH.....	26

Table of Contents (Cont.)

Suspension (Cont.)	26-28	Driveline	36-42
Adjustable Link (Front Anti Roll Bar).....	26	Shifter Kit.....	36
Front Brake Line Bracket.....	26	Drive Shaft Loop Kit – Front.....	36
Wheel Stud & Nut Kit – Rear.....	26	Drive Shaft Loop Kit - Rear.....	36
Wheel Stud – Front.....	26	Differential Pump.....	36
Knuckle / Bearing Assembly LH.....	27	Differential Cooler and Fan Unit.....	36
Upper Shock Mount – RH / LH.....	27	Filter Screen for Differential Cooler.....	36
Lower Shock Mount Assembly, Bottom	27	Diff Cooler and Fan Unit Bracket.....	36
Rear Adjustable Drop Link.....	27	Half Shafts.....	37
Knuckle / Bearing Assembly RH.....	27	CV Boots – LH / RH.....	37
Lower Shock Mount, Top.....	27	Clutch.....	38
Rear Adjustable Toe Link Assembly.....	27	Cooling Lines.....	39
Rear Lower Control Arm LH.....	28	Catch Cans.....	40
Rear Lower Control Arm RH.....	28	Transmission Seal Locations.....	41
Rear Upper Camber Arm – LH.....	28	Rear Axle Seal Location.....	42
Rear Upper Camber Arm – RH.....	28	Steering	43
Rear Camber Shims.....	28	Steering Wheel.....	43
Dampers	29-30	Steering Hub.....	43
Spring Bearing Kit, Rear (2")	29	Steering Wheel Hook.....	43
Spring Bearing Kit, Front (2.5")	29	Multifunction Switch.....	43
Front Damper - LH.....	29	Quick Release w/ Hardware.....	43
Rear Damper – LH/RH.....	29	Wheels & Tires	44-45
Front Damper - RH.....	29	Wheels.....	44-45
Front Camber Adjuster Plates.....	29	Mustang Challenge Tires.....	44
Front and Rear Spring Options.....	30	Mustang Cup Tires.....	45
Brakes - ABS	31	Data	46
Dark Horse R ABS M5 Clubsport Kit....	31	Data System, MC187.....	46
ABS Sensor - Front LH.....	31	Data System Bracket.....	46
Front ABS Wire Hanger LH / RH.....	31	Oil / Trans Temperature Sensor.....	46
ABS Bracket.....	31	Data System GPS Antenna.....	46
MSA Box, Signal Converter.....	31	ProCal 4.....	46
ABS Sensor - Front RH.....	31	Optional Shift Light Module.....	46
ABS Wire Bracket LH / RH.....	31	Electrical	47-49
Front Brakes	32-33	Battery Harness, Modified.....	47
Brake Pad.....	32	Breaker to Relay Cable.....	47
Front Caliper Bracket w/ Hardware.....	32	IP (Dash) Harness, Modified.....	47
Front Brake Backing Plate LH / RH Kit..	32	Battery to Breaker Cable.....	47
Brake Pad.....	32	PDB Harness, Modified.....	47
Front Caliper – LH / RH.....	32	Front Loom.....	47
Brake Disc Assembly.....	33	Cockpit Loom.....	47
Brake Lines	34-35	Body Harness, Modified.....	47
Stainless Steel Brake Lines.....	34	Switch Panel / Harness.....	48
Flexible Brake Lines.....	35	Door Harness - RH.....	48

Table of Contents (Cont.)

Electrical (Cont.)	47-49	Appendix	65-110
Door Harness - LH.....	48	Driver Safety Harness.....	66
Master Power Panel.....	48	Master Power Electrical Switch.....	67
Steering Wheel Switch Plate / Harness.....	48	Fire Suppression System.....	68
Diff Temp / Rear Chassis Harness.....	48	Air Jack System.....	69-73
Diff Pump Jumper Harness.....	48	Radio.....	74
Fuel Pump Jumper Harness.....	48	Mustang Challenge – Yellow Flag Warning System.....	75
Main Breaker.....	49	Mustang Cup – Safety System.....	76-77
Relay.....	49	Transponder System.....	78
Can Bridge Module.....	49	Incident Data Recorder.....	79
Safety Equipment	50-57	Camera System.....	80-81
Driver Safety Harness.....	50	Driver Cooling System.....	82-83
Safety Seat Bracket.....	50	Ride Height Reference Points.....	84
Driver Window Net.....	50	Service Engine Pigtails.....	85-87
Helmet Support Net, Left Side.....	50	Bill of Materials.....	88-109
Safety Seat.....	50	Additional Parts.....	110
Window Net Mounting Kit.....	50	Change Log.....	111
Helmet Support Net, Right Side.....	50		
Roll Bar Padding.....	50		
Optional Seat / Mount	51		
Seat Mounting Plate.....	52		
Window Nets.....	53-54		
Safety Harness and Helmet Support Net Collars.....	55		
Roll Bar Padding Locations.....	56		
Fire Suppression System.....	57		
Recommended Fluids	58		
General Pictures	59-64		
Under Hood / Trunk.....	59		
Interiors.....	60		
Front Wheel Well.....	61		
Rear Wheel Well.....	62		
Body In White (BIW).....	63		
Chassis Serial Number.....	64		

General Notes

- This homologation document is for Mustang Challenge and Mustang Cup
 - Mustang Challenge is sanctioned by IMSA (International Motor Sports Association)
 - Mustang Cup is sanctioned by USAC (United States Auto Club)
- Adjustments or modifications not specified in this document are not allowed
- The only optional equipment allowed is shown in this document
- All parts on vehicle must be production Ford Mustang Dark Horse components unless specifically listed in this document as detailed in the Bill of Materials
- Fluids are unrestricted. The recommended fluids are listed in this document
- Valve stem specification is open. Valve stem caps are required
- This homologation document may be updated if vehicle specification changes are made
- Updates will be available on the Ford Performance website
 - Mustang Challenge: [Competitor Info – Mustang Challenge](#)
 - Mustang Cup: [Competitor Info – Mustang Cup](#)

Interior



Dash Panel
DHR-DASH-MOD



Dash Panel Top
DHR-DASH-MOD



Dash Panel Closeout
DHR-DASHCLOSEOUT



Center Vents Assembly
WMOD-C044K30-FB319W



OBD2 Mounting Plate
DHR-OB2-MNT-PLT



Dead Pedal Kit
WR-DEADPEDAL



Heat Shield
DHR-FLOOR-HT-SHLD



IMAGE
COMING

Additional Heat Shield (Optional)
TBD

Interior



Ballast Cover
20017-03-0182AA01



Ballast Mount w/ Hardware
200171-14-0000



Rear View Mirror
JOES-11284



Rear View Mirror Brackets
JOES-11284



5" Rear View Mirror Brackets (Optional)
JOES-11264



9" Rear View Mirror Brackets (Optional)
JOES-11294



Side View Mirror (Optional)
JOES-11214



Extended Side View Mirror Bracket (Optional)
JOES-11234

Interior – Ballast



Ballast Assembly Location – Passenger Side Floor
Ballast Assembly may be removed if not required

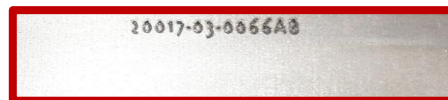
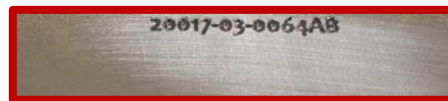

Ballast Plates (Not Included)
FIA Approved Ballast Plates are Allowed

Interior – Driver Door



Door Foam – LH
DHR-IMPAXX-LHFOAM



Inner Door Panel – LH
DHR-INNR-DOOR-PNL



Door Latch Assembly – LH
DHR-DOORLTCHCABL

Exterior



Tow Hook Kit – Rear
FP-17954-RDH



Tow Hook Kit – Front
FP-17654-FDH



Hood Pins
120-4000



Rear Deflector
DHR-AIRDEFLCTR-MOD



Tie Down Kit – Front / Rear
M-1700-M



Exterior Power Panel (Master Power / Fire Suppression
Pull Cable)
DHR-EXTRPWRPNL



Battery Tray
DHR-BATBOX-MOD



Transponder Bracket
DHR-LAPSRKBT

Front



Front Fascia Assembly w/ Upper and Lower Grill Mesh
FP-17000-DHR
DHR-MESHGRL-UPR / DHR-MESHGRL-LWR



Front Fascia Assembly w/ Upper and Lower Grill Mesh
FP-17000-DHR
DHR-MESHGRL-UPR / DHR-MESHGRL-LWR

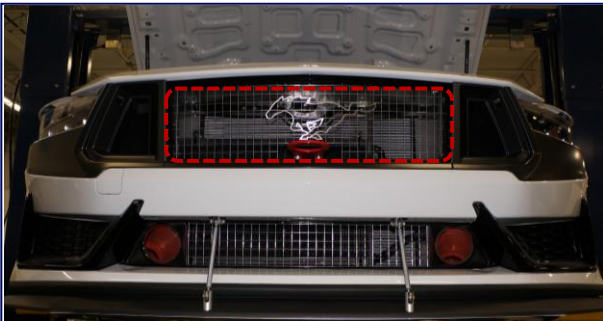

Upper Grill Mesh with Mustang Emblem (Optional)
DHR-MESHGRL-UPRA



Radiator Closeout
DHR-RADCLOSEOUT



Cowl Top Assembly
DHR-COWEL-MOD



Brake Duct Hose Kit
LCR-DH-BHKA / LCR-DH-BHK

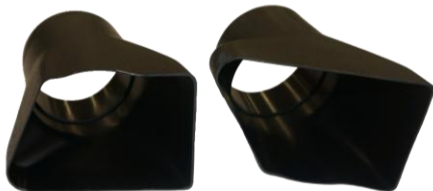

Brake Duct Inlets
LCR-DH-BDK



Brake Duct Mounting Bracket
DHR-BRK-DCT-MNT-BRKT

Front



Splitter Pencil Rod
LCR-DH-PENCIL



Splitter Bumper Bracket
LCR-DHR-BMPR-BRKT



Splitter Support
LCR-DHR-SPLTR



Splitter Support Assembly

Trunk / Rear



Rear Fascia
FP-17500-DHR



Wing Wicker
DHR-WING-EXTEN



Rear Closeout
DHR-REARCLOSEOUT-AS



Trunk Latch
WMOD-7643282-BB



Trunk Release Handle Location
– Must be clearly labeled –



Trunk Release Handle Cover (Optional)

Engine



Sealed Engine – View 1
FP-6007-DHR



Sealed Engine – View 2
FP-6007-DHR



Sealed Engine – View 3
FP-6007-DHR



Sealed Engine – View 4
FP-6007-DHR

Engine – Seal Location



Engine Seal 1
Timing Cover Seal

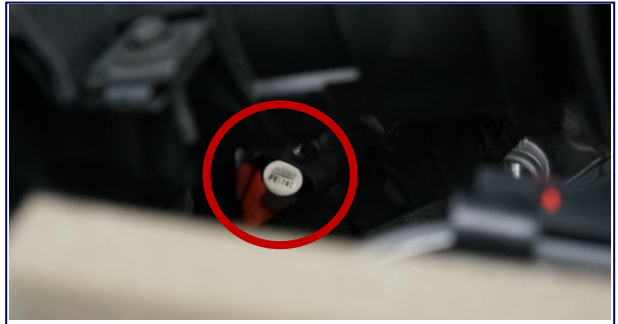

Engine Seal 1
Timing Cover Seal



Engine Seal 2
Valve Cover LH Seal



Engine Seal 2
Valve Cover LH Seal



Engine Seal 3
Valve Cover RH Seal



Engine Seal 3
Valve Cover RH Seal



Engine Seal 4
Intake Manifold Seal



Engine Seal 4
Intake Manifold Seal

Engine



Oil Cooler
SET50-960-7612



Oil Cooler Adapter
M22AN12-SE



Catch Can
PTR08-0400-FPR



Oil Cooler Fitting Adapter Kit
LCR-OCA-12



Catch Can Bracket
PVC-TRNS-VNT-BRKT



Catch Can to Oil Pan Drain Back Hose
CATCH-CAN-DRAINBACK-HOSE

Engine Cooling



Oil Cooler Line 1, Engine Out / Cooler In
S650-DHR-OIL-LINE1A / S650-DHR-OIL-LINE1



Oil Cooler Line 2, Cooler Out / Engine In
S650-DHR-OIL-LINE2A / S650-DHR-OIL-LINE2



Heater Hose (Optional for Cars 001-040)
WR-18K580-MODA



Heater Hose
WR-18K580-MOD

Engine Cooling



Radiator (Optional for Cars 001-040)
CR-CC-Y1196-002



Radiator
CR-CC-Y1100-002



Lower Radiator Aluminum Hose
FP-8286-A



Zip Tie Stud Mount
157-00291



Lower Radiator Soft Hose, 5.5 in
Inlet to Thermostat Housing
FP-8286-B



Lower Radiator Soft Hose, 4.5 in
Radiator Side
FP-8286-C

Engine Cooling



Fan Shroud Modification
Required

Exhaust



Headers LH/RH
FP-9430-DHRL / FP-9430-DHRR



X-Pipe
FP-5200-DHRX



LH Collector Pipe
FP-5200-DHRLC



RH Collector Pipe
FP-5200-DHRRC



LH Tail Pipe
FP-5200-DHRLT



RH Tail Pipe
FP-5200-DHRRT

Exhaust – Heat Wrap

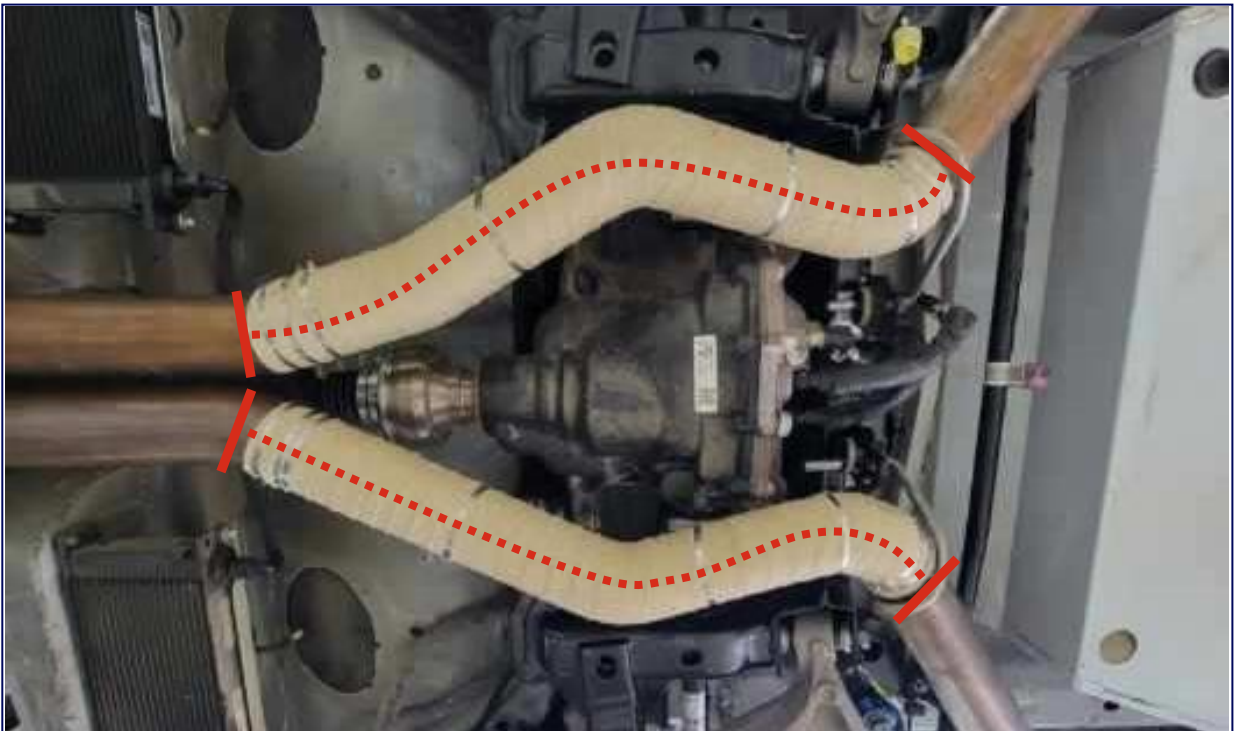

Exhaust Heat Wrap Location (Red Dotted Line)
Use a 50% overlap of the heat wrap. Use band clamps on both ends, additional clamps may be used.



COOL IT Thermo Tec Exhaust Insulating Wrap, 2"
THT-11002

Fuel Cell



Fuel Cell Spacer
DHR-FUEL-SPACER



Fuel Cell Lid
DHR-FUEL-SPACER



Fuel Line Fitting
GEN-GA3186



Plate (Fuel Pump Block Off)
DHR-FUELPMPBLKOFF

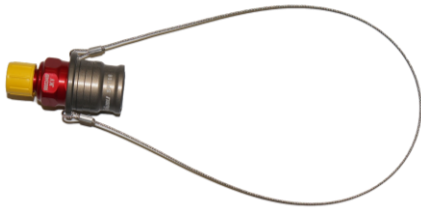

Ball Locking Break Socket (Red)
STA-SPT08.3655/L/JKV



Ball Locking Break Plug (Red)
STA-SPT08.7655/L/JKV



Fuel Cell Bladder Assembly
LCR-DH-FUELCELL

Fuel Cell

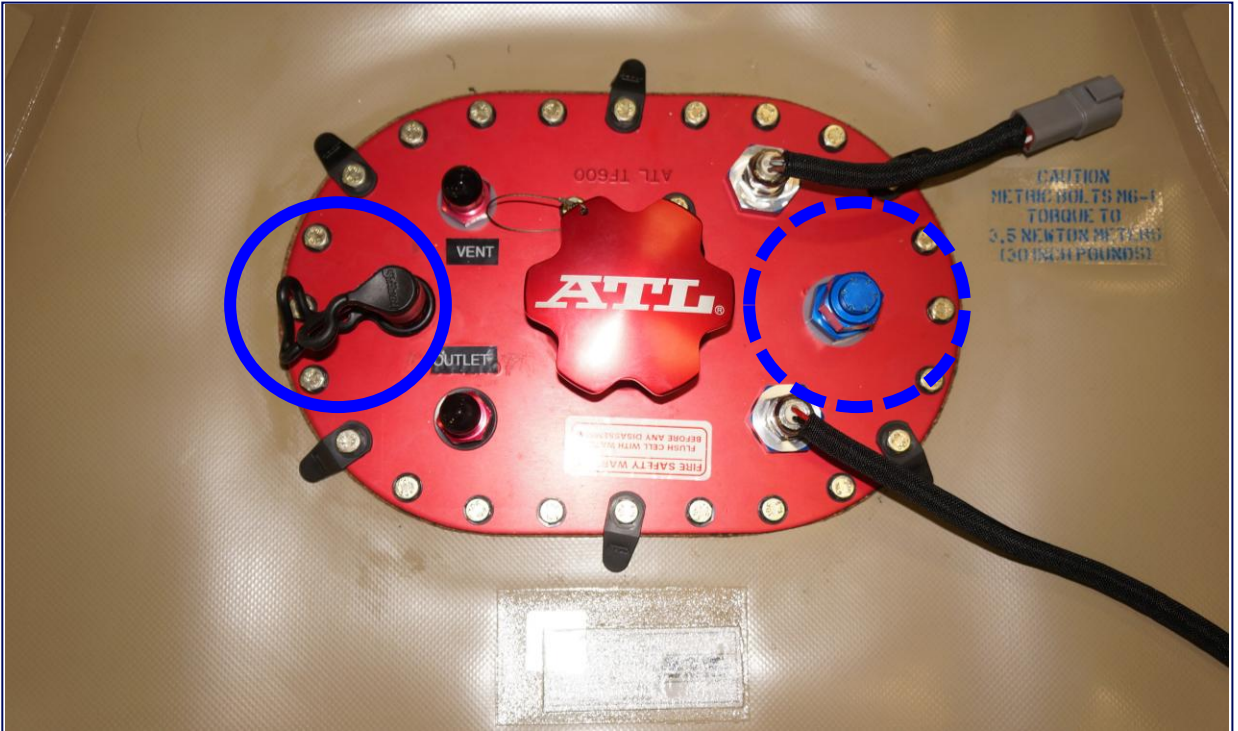

Fuel Cell Fitting Location
Quick Disconnect (Circled with Solid Blue Line) / -8 AN Bulkhead (Circled with Dotted Blue Line)



Quick Disconnect & Nut
SPT08.5655/L/JKV
REQUIRED



-8 AN Bulkhead Fitting & Nut / Cap
AN929-8D / TF232
OPTIONAL

Fuel Lines



Fuel Line – Factory to Bulkhead
S650-DHR-FUEL-LINE1



Fuel Line – Bulkhead to Quick Release
S650-DHR-FUEL-LINE2



Fuel Line – Quick Release to Cell
S650-DHR-FUEL-LINE3

Frame / Mounting



Front Subframe (K Member)
WMOD-5C145-A



Rear Subframe
DHR-SUBFRAME-MODA

Suspension



Bearing Kit for Control Arms - Front / Rear
SBK-60-1000



Bearing Kit for Control Arms - Front / Rear
SBK-60-1000



Front Lower Arm Assembly – LH
DHR-FCNTRLBRNG-MODL



Front Lower Arm Assembly – RH
DHR-FCNTRLBRNG-MODR



Adjustable Link (Front Anti Roll Bar)
DHR-FRTSWYBRLINK-AS



Front Brake Line Bracket
S650-DHR-RH-FRT-BRAKE-LINE-BRKT



Rear Wheel Stud & Nut Kit
M-1107-E



Front Wheel Stud / Nut
10-0119 / 40-0001-B

Suspension



Knuckle / Bearing Assembly LH
CM-5B759-S650



Knuckle / Bearing Assembly RH
CM-5B758-S650



Upper Shock Mount – RH / LH
DHR-RUPRSHKMOUNT



Lower Shock Mount, Top
LCR-LSBRKT-DH



Lower Shock Mount Assembly, Bottom
DHR-RLOWERSHKMNT



Rear Adjustable Toe Link Assembly
DHR-TOE-LINK-ASSY-R2



Adjustable Rear Drop Link w/ Hardware
LCR-DH-RSBL

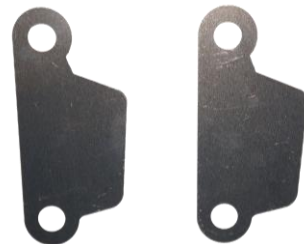

Front Knuckle Backing Plate
DHR-FT-BEAR-CV

Suspension



Rear Lower Control Arm LH
DHR-RCNTRLBRNG-MODL



Rear Lower Control Arm RH
DHR-RCNTRLBRNG-MODR



Rear Upper Camber Arm – LH
200171-12-1017



Rear Upper Camber Arm – RH
200171-12-1016



Rear Camber Shim, 0.5mm (.13 Deg)
200171-12-1004 AB



Arm Camber Shim, 1.0mm (.26 Deg)
200171-12-1006 AB



Rear Camber Shim, 1.5mm (.39 Deg)
200171-12-1008 AB

Dampers



Spring, Rear (As Delivered)
18C1000



Spring, Front (As Delivered)
187B0700



Spring Bearing Kit, Rear (2")
GEN-GC1017



Spring Bearing Kit, Front (2.5")
GEN-GC1015



Front Damper Assembly – LH/RH
FP-18000F-DHR



Front Camber Adjuster Plates – LH/RH
FR-18183L-DHR / FR-18183R-DHR



Rear Damper Assembly – LH/RH
FP-18000R-DHR



Front Camber Shims
PIA to Front Camber Adjuster Plates

Optional Front / Rear Springs

Front Hyperco Springs

SKU	Inside Diameter [in]	Free Length [in]	Rate [lbs/in]	Deflection [in]	Load [lb]	Outside Diameter [in]	Solid Height [in]	Color
187B0500	2.5	7	500	4.403	2202	3.661	2.597	Blue
187B0600	2.5	7	600	4.260	2556	3.708	2.740	Blue
187B0700	2.5	7	700	4.103	2872	3.687	2.897	Blue
187B0800	2.5	7	800	3.991	3192	3.729	3.009	Blue
187B0900	2.5	7	900	3.793	3413	3.834	3.207	Blue



Rear Hyperco Springs

SKU	Inside Diameter [in]	Free Length [in]	Rate [lbs/in]	Deflection [in]	Load [lb]	Outside Diameter [in]	Solid Height [in]	Color
186C0700	2	6	700	3.317	2322	3.009	2.683	Blue
186C0800	2	6	800	3.293	2634	3.203	2.707	Blue
186C0900	2	6	900	3.146	2831	3.156	2.854	Blue
186C1000	2	6	1000	3.070	3069	3.128	2.930	Blue



ABS



Dark Horse R ABS M5 Clubsport Kit
FP-2353-DHR



MSA Box, Signal Converter
F02U.V00.327-03



ABS Sensor - Front LH
JR3C-2C204-B1B



ABS Sensor - Front RH
JR3C-2C205-B1B



Front ABS Wire Hanger LH / RH
S650-DHR-FRT-ABS-WIRE-BKRT-ASSY



ABS Wire Bracket LH / RH
PR3C-2C224-AA / PR3C-2C224-BA



ABS Bracket
DHR-ABSBKRT-AS



ABS Pressure Sensor Fitting
LCR-DH-BOSCH-ADP

Front Brakes

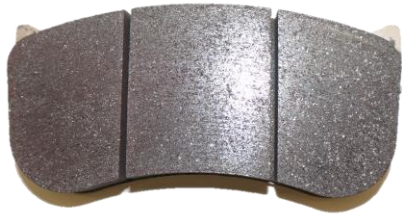

Brake Pad
P1309.17.F01



Brake Pad
P1309.17.F01



Front Caliper Bracket w/ Hardware
20B71805



Front Caliper – LH / RH
XB8GK51 / XB8GK52



Front Brake Backing Plate LH / RH Kit
DHR-BRAKE-BKNG-PLT-L / R

Front Brakes



Brake Disc Assembly
759B97936

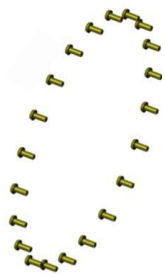

Bell Ring Bolts
5582916



Bell Ring
05A46739



Disc
759B97936 (LH) / 759B97946 (RH)



Bell
16B71452

SS Brake Lines



Master Cylinder to ABS – Front
DHR-BRKLIN1



Master Cylinder to ABS – Rear
DHR-BRKLIN2



Rear Brake Lines, ABS to Rear LH
DHR-BRKLIN3



Rear Brake Lines, ABS to Rear RH
DHR-BRKLIN4

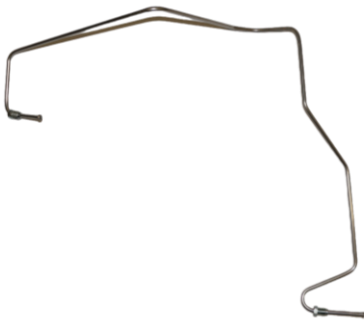

Front Brake Line – LH
DHR-BRKLIN5



Front Brake Line – RH
DHR-BRKLIN6

Flexible Brake Lines

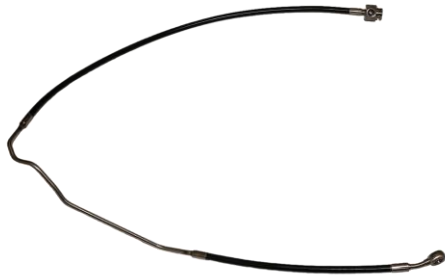

Rear Brake Line – LH
FORDM-B01

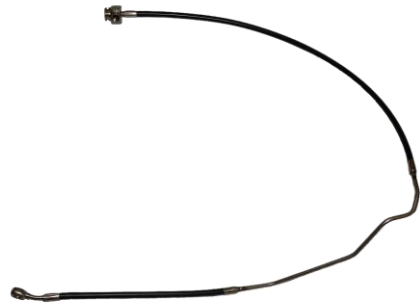

Rear Brake Line – RH
FORDM-B02

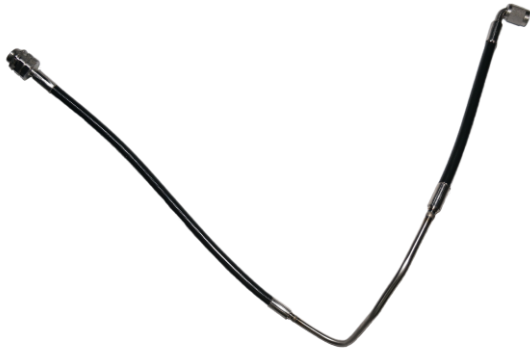

Front Brake Line – LH
FORDM-B05



Front Brake Line – RH
FORDM-B04



Front Brake Line Caliper Fitting / Copper Washer
06.2196.13 / 06.3710.20



Master Cylinder Fitting
9183-MTN

Driveline



Drive Shaft Loop Kit – Front
CM-5478-MGTF



Drive Shaft Loop Kit - Rear
CM-5478-350S-R



Differential Pump
GEN_GC1111



Bracket (Diff Pump to Body)
DHR-DIFFPMPBRKT-AS



Differential Cooler and Fan Unit
SETFP920M22I



Differential Cooler and Fan Unit Bracket
DHR-DIFF-CLR-BRKT



Filter Screen for Differential Cooler
SET11-UF08



Shifter Kit
LCR-7210-A

Optional Shifter Knob
LCR-7210-A

Driveline – Half Shafts



Half Shaft LH
DHR-HALFSHAFT-MODLA



Half Shaft RH
DHR-HALFSHAFT-MODRA



CV Boot – LH
M-3A331-GT4A



CV Boot – RH
M-3A331-GT4B

CV Boots can be used for both inboard and outboard locations

Driveline – Clutch



Clutch Pressure Plate
FP-7563-DHR

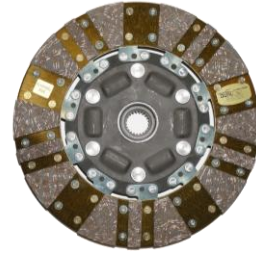

Disc
FP-7550-DHR



Flywheel
FP-6375-DHR



Throwout Bearing
FP-7508-DHR



Pressure Plate Hardware
(Included in FP-6375-DHR)



Pressure Plate Hardware
(Included in FP-6375-DHR)



SS Clutch Line
S650-DHR-CLUTCH-LINE



Clutch Master Feed Kit
LCR-CMFK-DH

Driveline – Cooling Lines

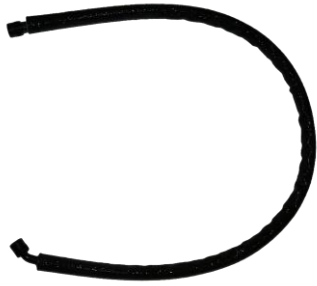

LH Cooler Out / Differential In
S650-DHR-DIFF-LINE-HOSE1



Pump Out / RH Cooler In
S650-DHR-DIFF-LINE-HOSE2



Differential to Pump In
S650-DHR-DIFF-LINE-HOSE3A /
S650-DHR-DIFF-LINE-HOSE3



RH Cooler Out / LH Cooler In
S650-DHR-DIFF-LINE-HOSE4



Oil Cooler Line, Transmission In
DHR-TRNS-CLR-LIN-1A / DHR-TRNS-CLR-LIN-1



Oil Cooler Lines, Transmission Out
DHR-TRNS-CLR-LIN-2A / DHR-TRNS-CLR-LIN-2



Transmission Oil Cooler Line
DHR-TRANSLINE-COOL



Trans Oil Cooler Tube Assembly
DHR-TRANSLINE-TRANS

Driveline – Catch Cans



Front Catch Can Kit – Transmission
DHR-FCTCHCAN-TRANS
(Optional for Cars 001-040)

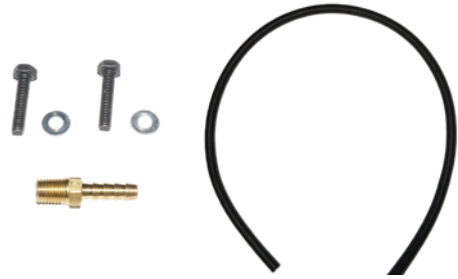

Rear Catch Can Kit – Differential
DHR-RCTCHCAN-DIFF
(Optional for Cars 001-040)



Catch Can
JOES-12310
(Optional for Cars 001-040)



Transmission / Differential Vent
MR3Z-7A246-B
Standard for Cars 001-040

Transmission – Seal Locations

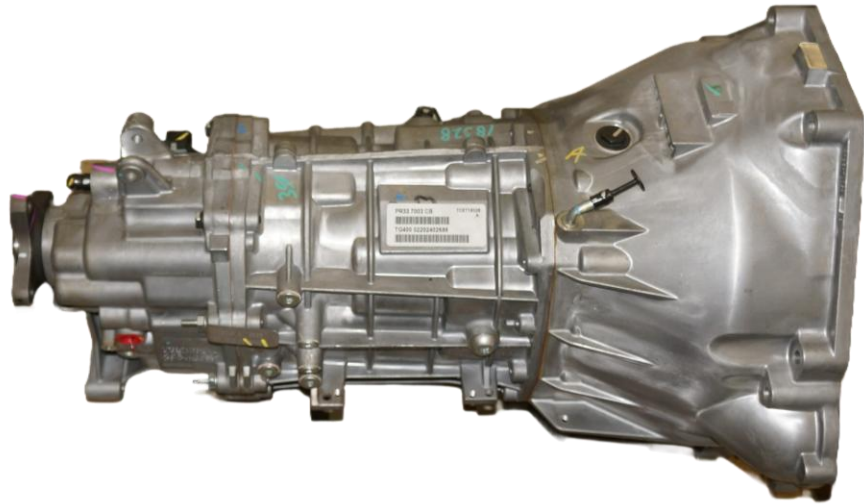

Sealed Transmission
FP-7003-DHR



Transmission Seal Location 1

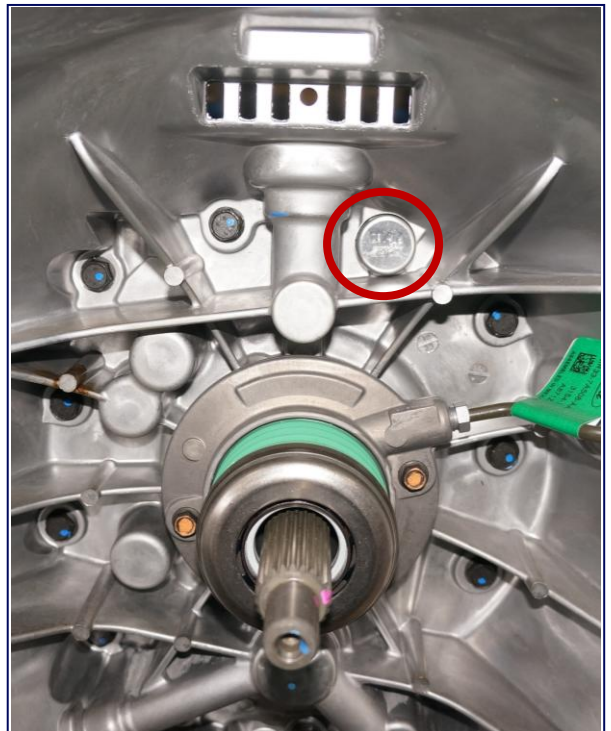

Transmission Seal Location 2
Inside Bell Housing

Rear Axle – Seal Location

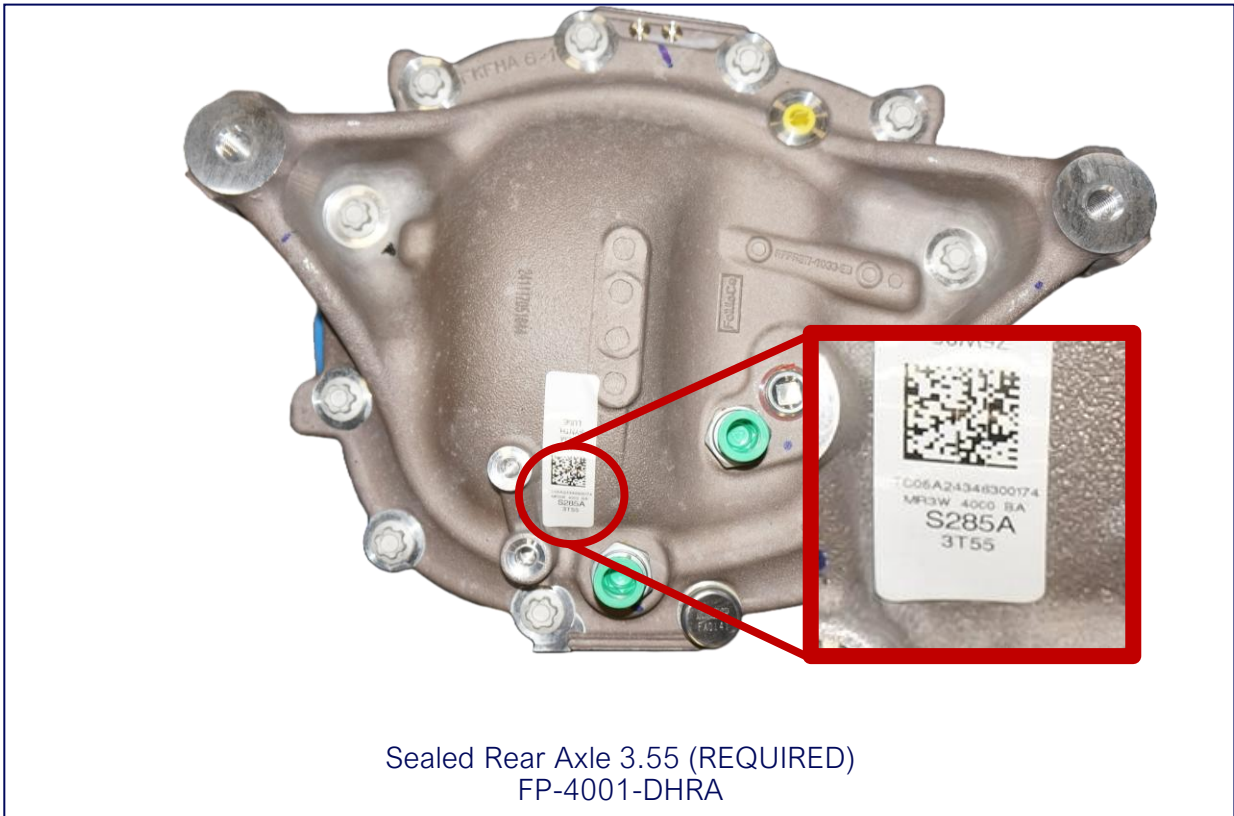

Sealed Rear Axle 3.55 (REQUIRED)
FP-4001-DHRA

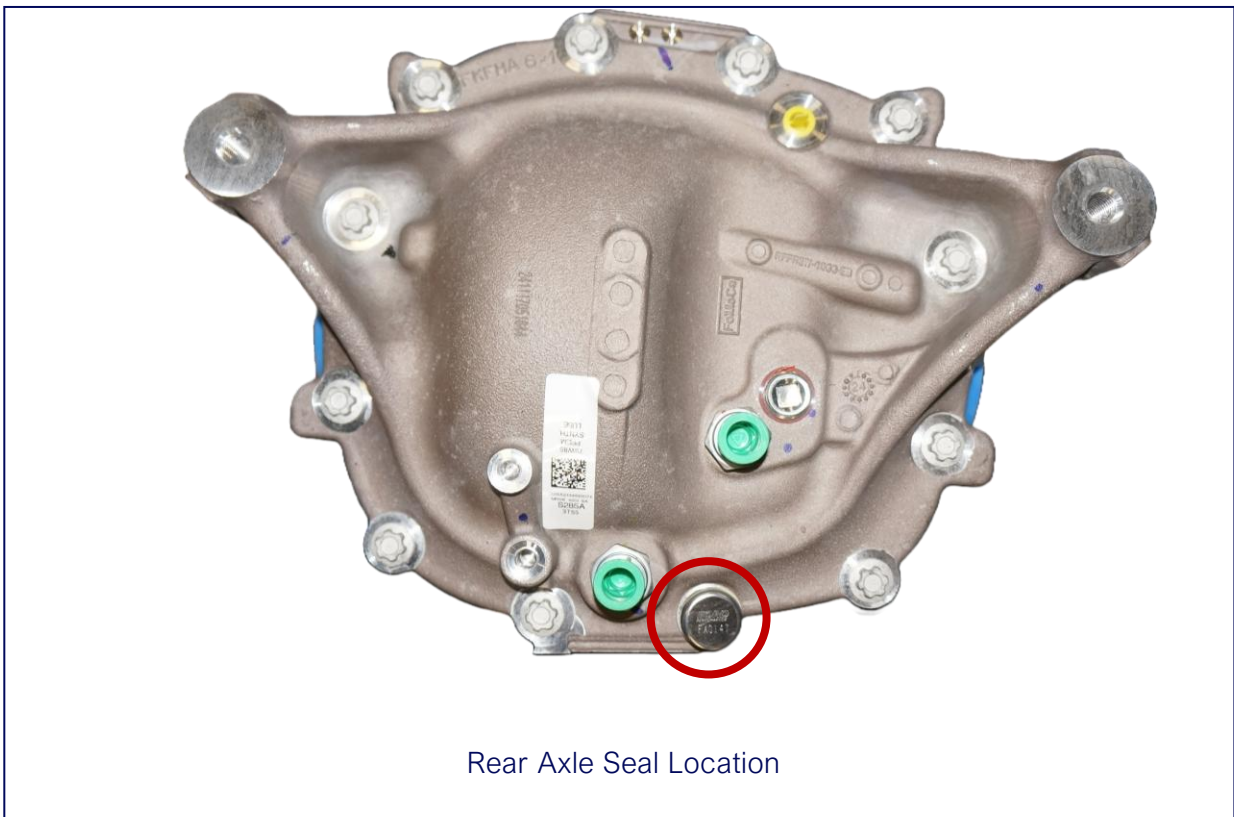

Rear Axle Seal Location

Steering



Steering Wheel
M-3600-RA



Multifunction Switch
DHR-CLMNSWTCB-MOD



Steering Hub
01502067CA



Quick Release w/ Hardware
015R98TU



Steering Wheel Hook
JOES-10704-B

Wheel & Tires – Mustang Challenge

MICHELIN



Mustang Challenge Tire – Slick
79759

MICHELIN



Mustang Challenge Tire – Rain
25100



Wheel
VS5RE1811ET52-AN



Wheel
VS5RE1811ET52-AN



Wheel Spacer
APX-SPCR-5114-28-B

Wheel & Tires – Mustang Cup

 YOKOHAMA.



Mustang Cup Tire – Slick
150100683

 YOKOHAMA.



Mustang Cup Tire – Rain
150100722



Wheel
VS5RE1811ET52-AN



Wheel
VS5RE1811ET52-AN



Wheel Spacer
APX-SPCR-5114-28-B

Data



Data System, MC187
M C187 Dark Horse R



Data System GPS Antenna
M GPS-L10



Bracket (Mount Screen to Clock Spring)
DHR-MOTECBRKT



ProCal 4
M-12655-F



Oil / Trans Temperature Sensor
M 25-2197D



Shift Light Module (Optional)
18120

Electrical



Battery Harness, Modified
PR3T-14B060-PGMOD



Battery to Breaker Cable
FP-14B060-AA



Breaker to Relay Cable
FP-14B060-BA



PDB Harness, Modified
PR3T-14290-FHLMOD



IP (Dash) Harness, Modified
PR3T-14401-EFMOD



Front Loom
FP-14290-AB



Main Body Harness, Modification
PR3T-14A005-CGLBMOD



Cockpit Loom
FP-14A005-AB

Electrical



Switch Panel / Harness
DHR-CENTERSTACK / FP-14401-BA



Master Power Panel
DHR-MSTR-PWR-PNL



Steering Wheel Switch Plate / Harness
FP-14A664-AA / DHR-STRNGWHLSWTCH



Diff Temp / Rear Chassis Harness
PR3T-2B572-FFMOD



Door Harness - RH
PR3T-14630-HGMOD



Door Harness - LH
PR3T-14631-KGMOD



Diff Pump Jumper Harness
FP-14A411-AA



Fuel Pump Jumper Harness
FP-2B572-AA

Electrical



Relay
TE 29-311-11



Main Breaker
Optifuse 353250



Can Bridge Module
M-14660-3FD
Standard for Cars 041+
(Optional for Cars 001-040)



Can Bridge Module
M-14660-2FD
(Standard for Cars 001-040)

Safety Equipment



Driver Safety Harness
SAB-CFCI22100056



Safety Seat
071.38.0630-01



Safety Seat Bracket
7206293NA



Window Net Mounting Kit
DHR-NETHRDWR

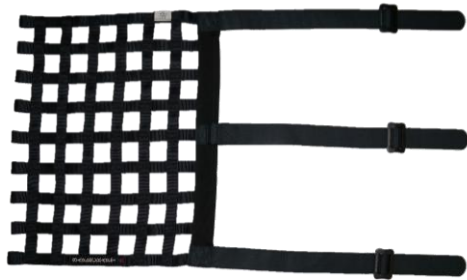

Driver Window Net
LCR-DH-LHWN

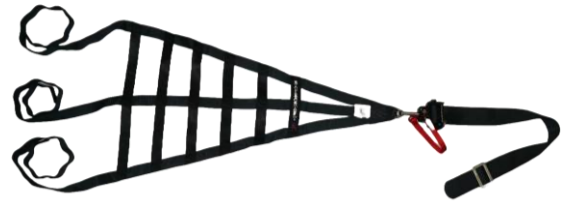

Helmet Support Net, Right Side
SFC-8011-K-FIA

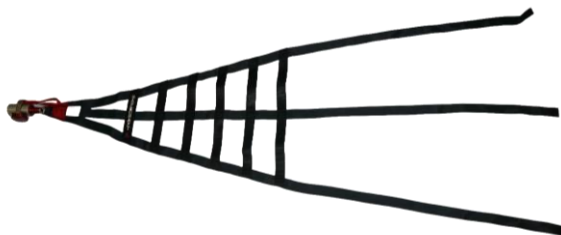

Helmet Support Net, Left Side
SFC-8111-K-L-FIA



Roll Bar Padding
BSCI-78001

Optional Seat / Mount



Optional Seat
071.28.UU11-01



Flexible Sidemount (Optional)
7221002NA



Seat Mount (Optional)
7207450A

Seat Mounting Plate

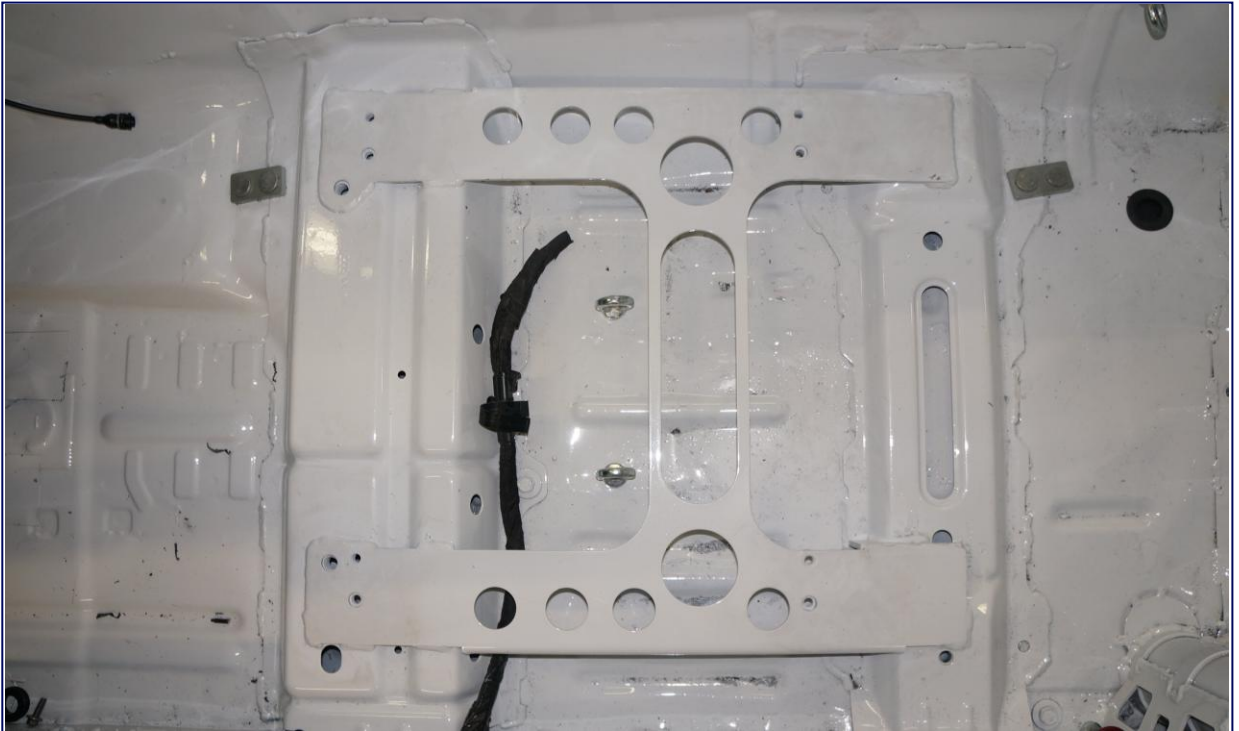

Standard Seat Mounting Plate for Cars 001-040



Standard Seat Mounting Plate for Cars 041-080
(Optional for Cars 001-040)

Window Nets



RH Helmet Support Net (Ratchet Release)
Mounting Points

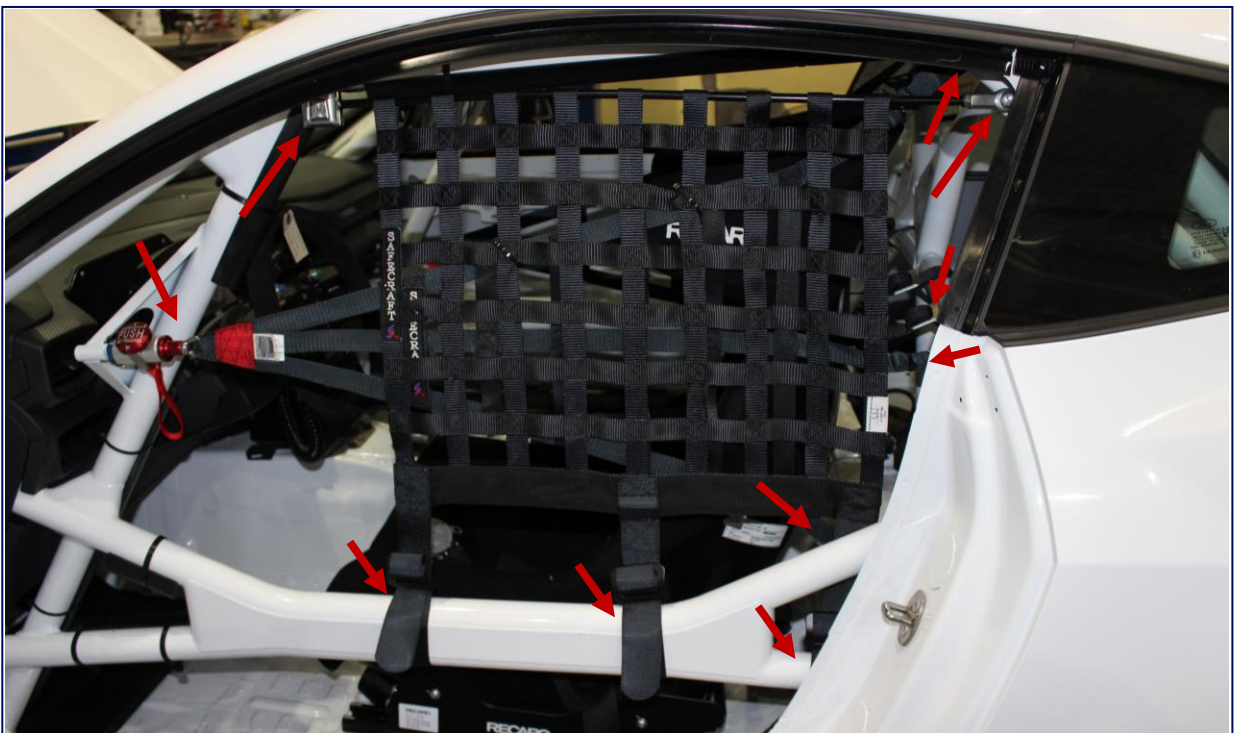

LH Driver Window Net + Helmet Support Net (Quick Release)
Mounting Points

Window Nets



Driver Helmet Support Net Mounting Points

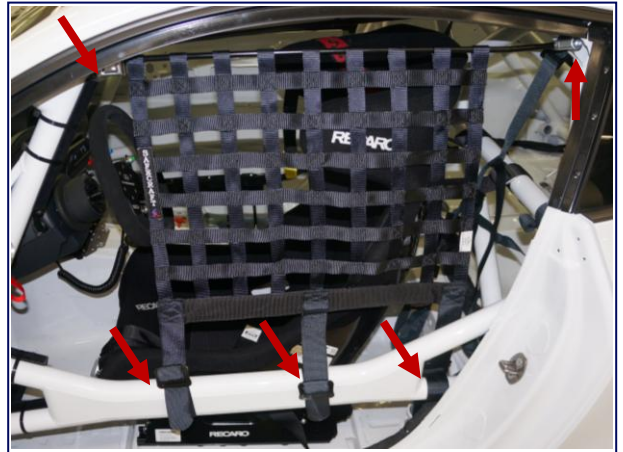

Driver Window Net Mounting Points



Driver Helmet Support Net Quick Release

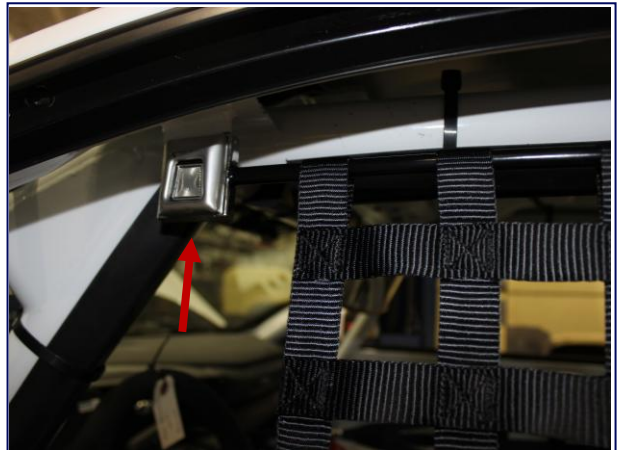

Driver Window Net Rod Release



Driver Helmet Support Net Mounting Points



Driver Window Net Rod Mounting Point

Safety Harness and Helmet Support Net Collars

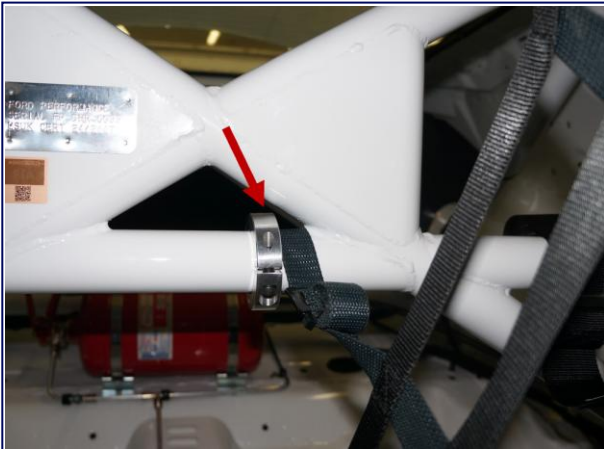

Helmet Support Net Collar Location
Main Safety Cage Center

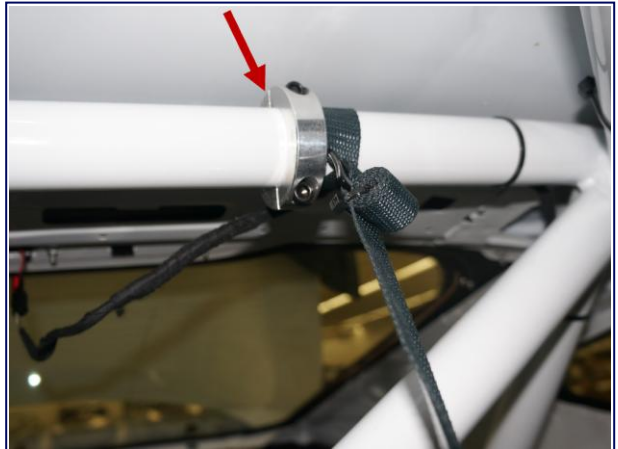

Helmet Support Net Collar Location
Main Safety Cage Hoop

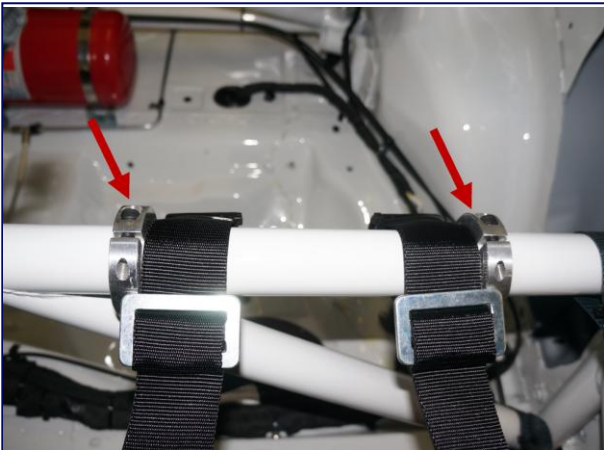

Safety Harness Collar Locations
Safety Cage Bar Behind Driver's Seat



2-Piece Lock Collar, 1.75in ID
GEN-GA3277

Roll Bar Padding



Roll Bar Padding Locations



Roll Bar Padding Locations

Safety Equipment – Fire Suppression System



Fire Bottle / Mount
014772MSL

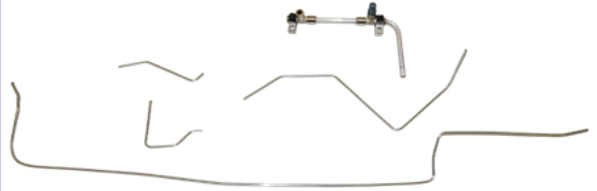

Fire Suppression Lines
014772MSL



Fire Suppression System Fittings / Nozzles
014772MSL



Fire Suppression System Pull Cable
014772MSL

Recommended Fluids



Gear Lubricant, Ford Motorcraft 75W-85
XY-75W85-QL



Motor Oil, Ford Motorcraft 5W-50
XO-5W50-QGT



Coolant (Motorcraft Gold) (50/50)
VC-13-G



Trans Fluid (Motorcraft Mercon LV)
XT-10-QLVC



Brake Fluid, Brembo HTC64
04816420

Under Hood / Trunk



Under Hood View



Trunk View

Interiors



Interiors – View from Driver's Door



Interiors – View from Passenger's Door

Front Wheel Well

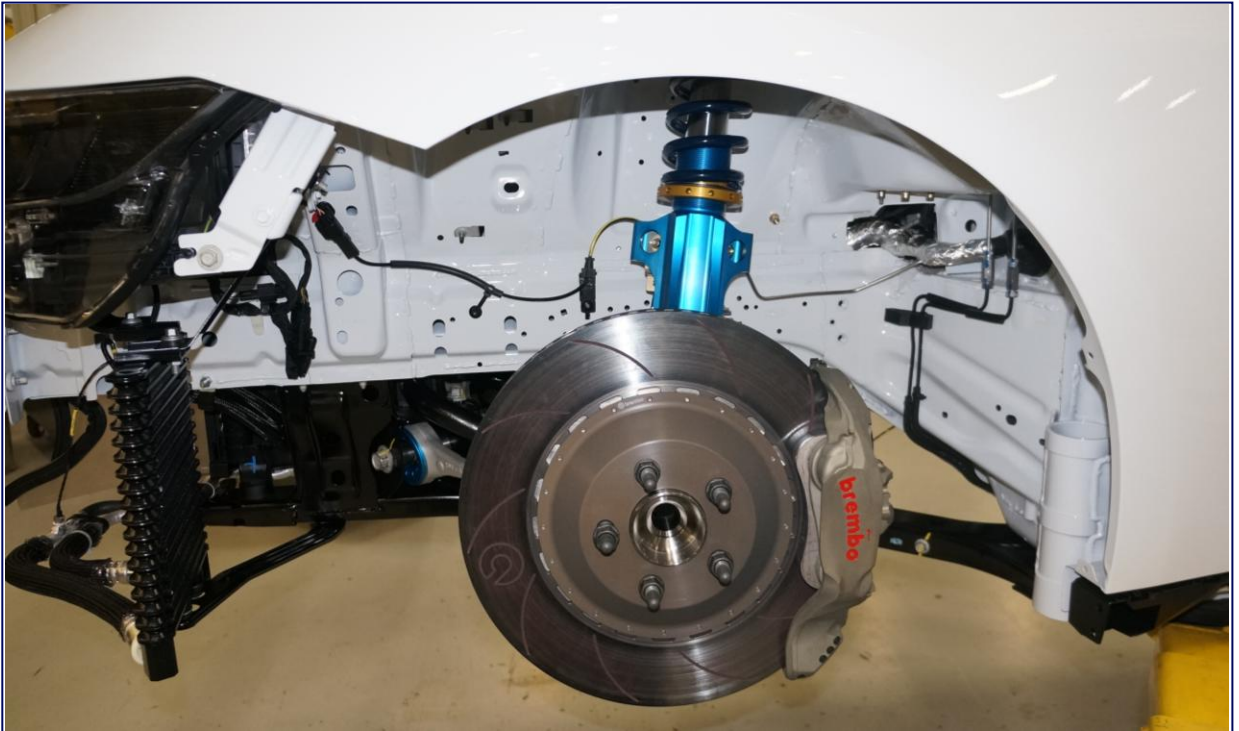

Front Driver Side Wheel Well

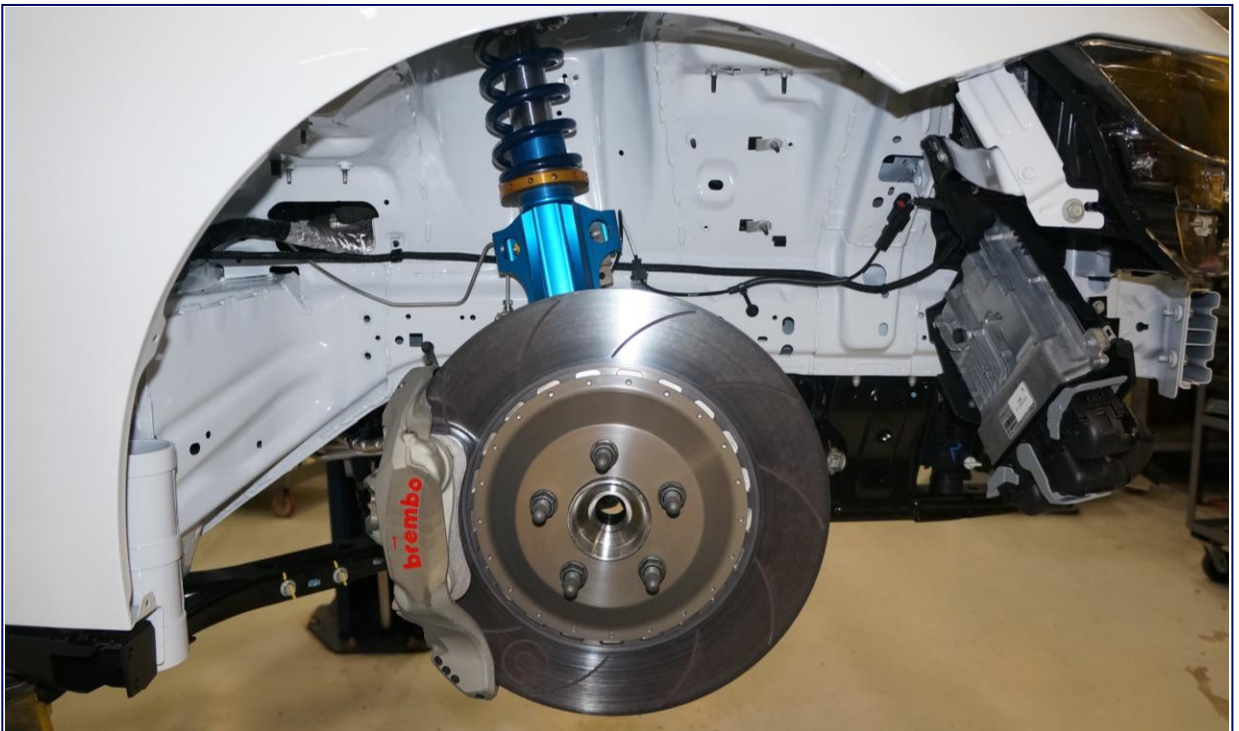

Front Passenger Side Wheel Well

Rear Wheel Well



Rear Driver Side Wheel Well



Rear Passenger Side Wheel Well

Body in White (BIW)



Caged BIW Mustang Dark Horse R
CFP-607100-DHR



Caged BIW Mustang Dark Horse R
CFP-607100-DHR

Chassis Serial Number



Chassis Serial Number – Windshield Tag
Standard (As Delivered)



Chassis Serial Number – Windshield Tag
BIW



Chassis Serial Number – Safety Cage Tag
Standard (As Delivered)



Chassis Serial Number – Safety Cage Tag
BIW



Safety Cage FIA Certification
Standard (As Delivered)

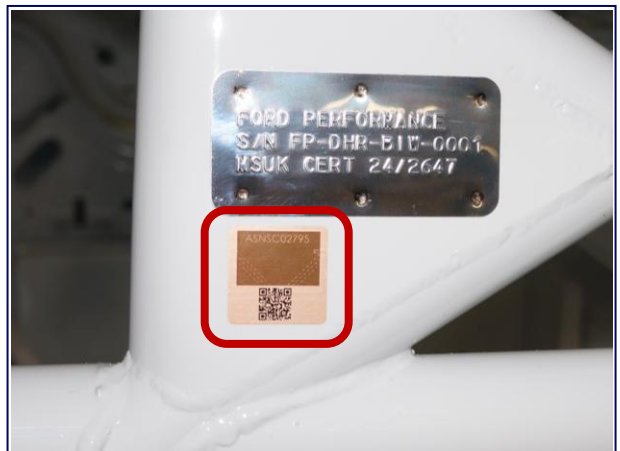

Safety Cage FIA Certification
BIW

Appendix

Driver Safety Harness System

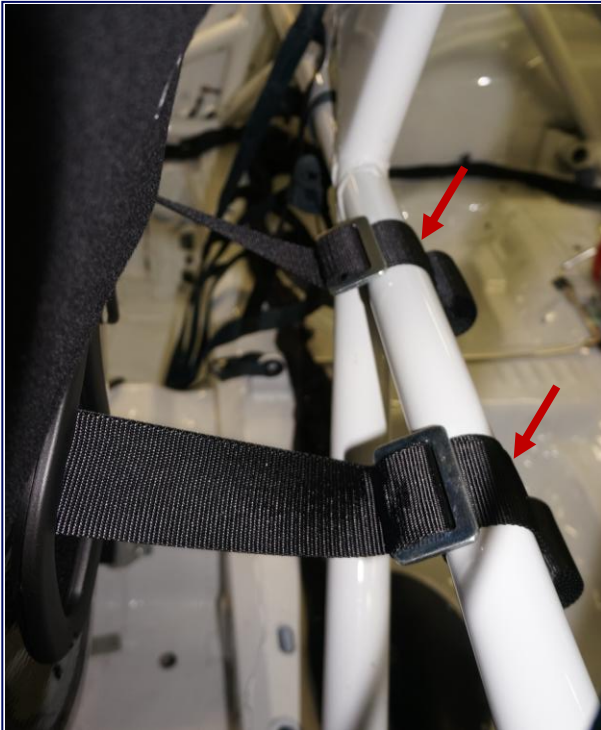

Harness Mounting Points
Roll Cage Behind Driver's Seat

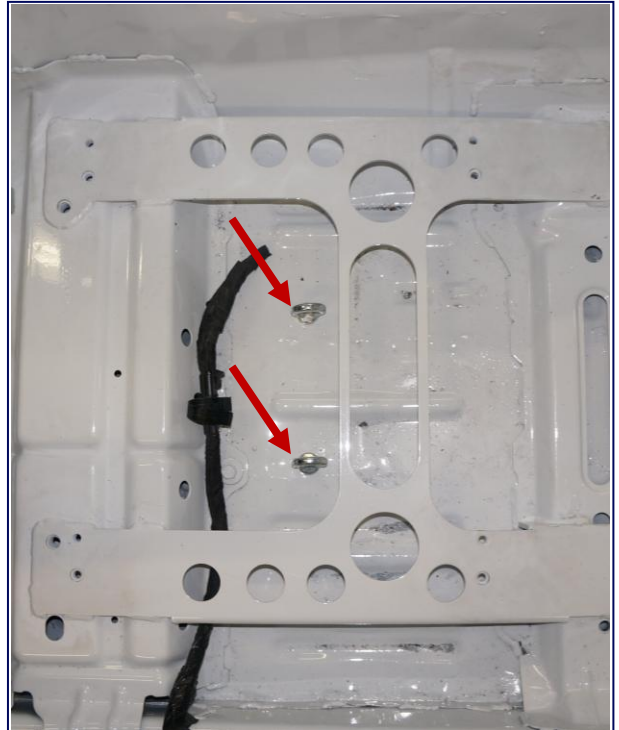

Harness Mounting Points
Driver's Side Floor



Harness Mounting Point
Driver's Side Rear

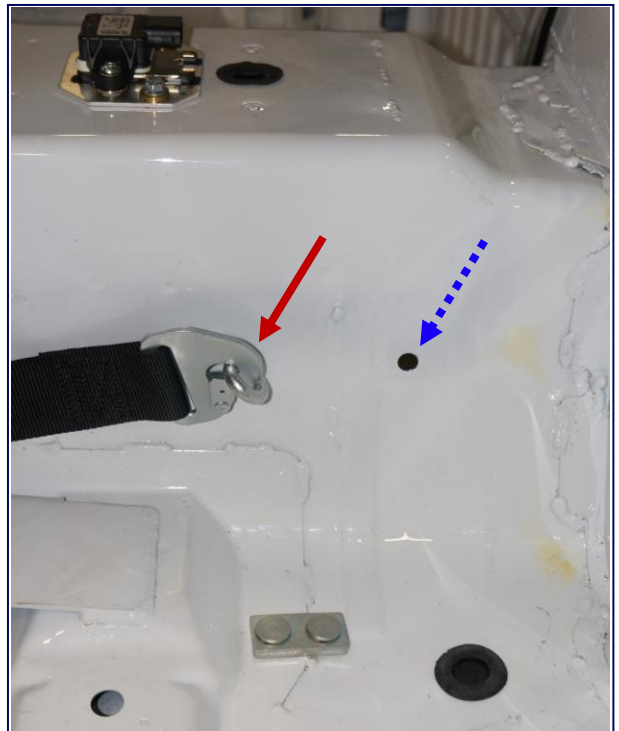

Standard Harness Mount Location (Red)
Optional Harness Mount Location for use with Inboard Seat
Mount Location (Blue Dashed)
Left Side of Drive Shaft Tunnel

Master Power Electrical Switch



Interior Master Power Electrical Switch
OFF – Down towards Floor / ON – Up towards Roof



Exterior Master Power Electrical Switch
Exterior Driver Side
OFF – towards Passenger Side / ON – towards Driver Side

Fire Suppression System

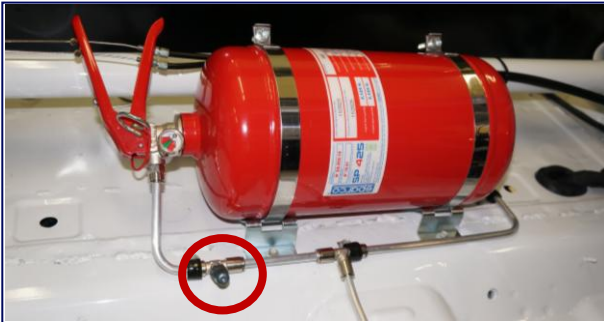

Fire Bottle Mount + Nozzle



Driver's Feet Nozzle

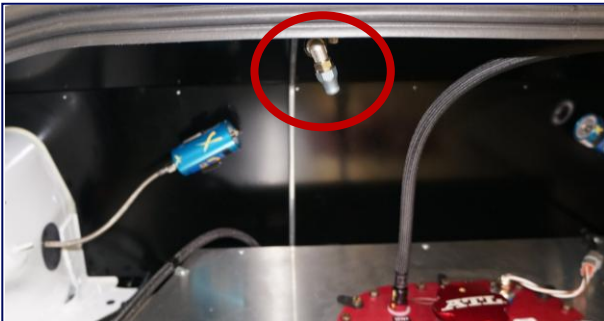

Fuel Cell Nozzle



Engine Bay Nozzle 1
Driver Side



Engine Bay Nozzle 2
Passenger Side

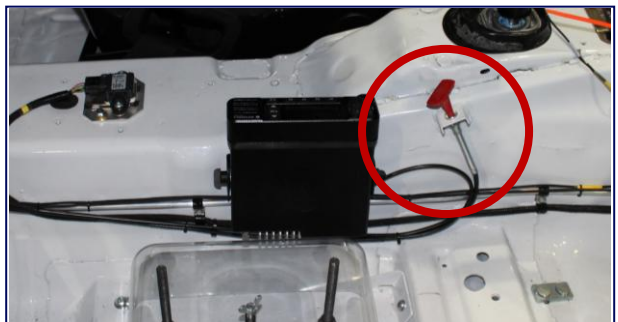

Interior Cable Pull
Right Side of Drive Shaft Tunnel



Exterior Cable Pull
Exterior Driver Side



Air Jack System – Optional



Air Jack Bezel
13052-09-1110 (Qty: 1)



Krontec Connecting Valve
KR0.LL.16 or KR0.LL.16PLUS (Qty: 1)



Krontec Air Lift
Std. 60mm M60 X 1.5 HUB 230 mm
KR0.LL.24 (Qty: 4)

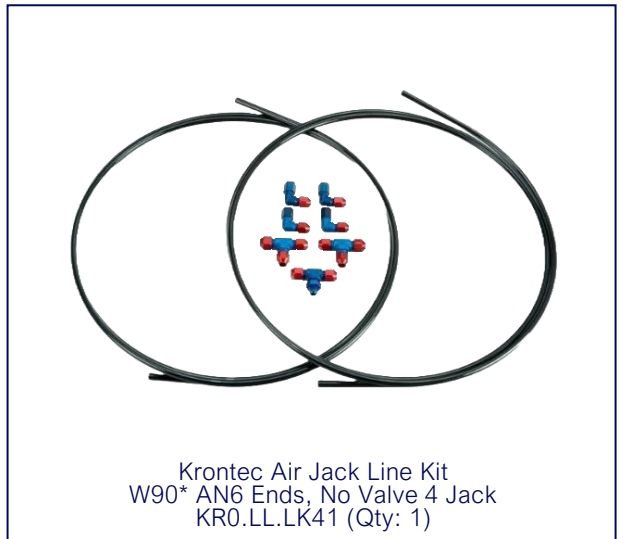

Krontec Air Jack Line Kit
W90* AN6 Ends, No Valve 4 Jack
KR0.LL.LK41 (Qty: 1)

Use routing locations as shown in this document.
Connection valve location is open.

Air Jack System – Optional

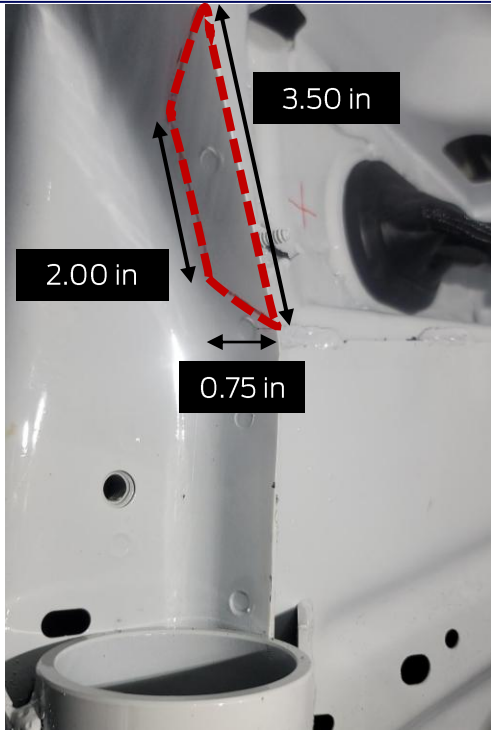

Front Seam Modification
Passenger Side Shown, Driver Side Opposite

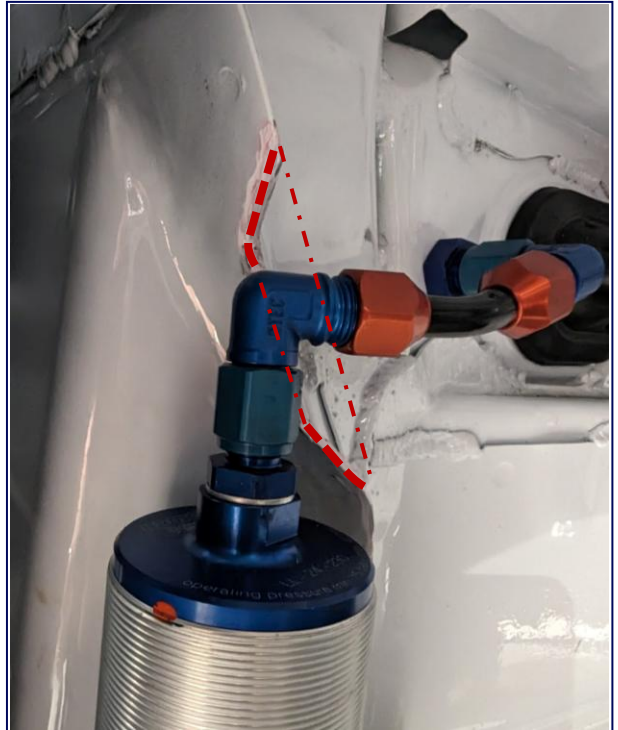

Front Seam Modification
Passenger Side Shown, Driver Side Opposite



Front Air Jack / Bulkhead Connection
Passenger Side



Front Air Jack / Bulkhead Connection
Driver Side

Air Jack System – Optional

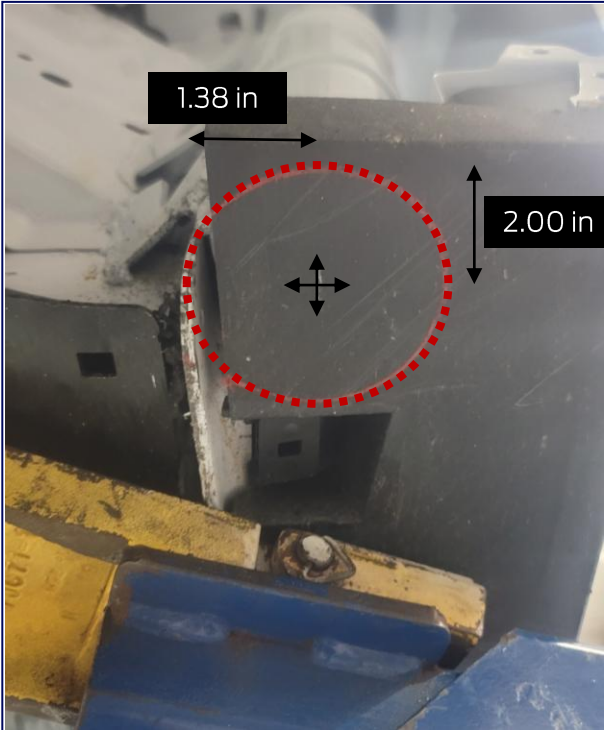

Front Air Jack Side Skirt Modification
Driver Side Shown / Passenger Side Opposite

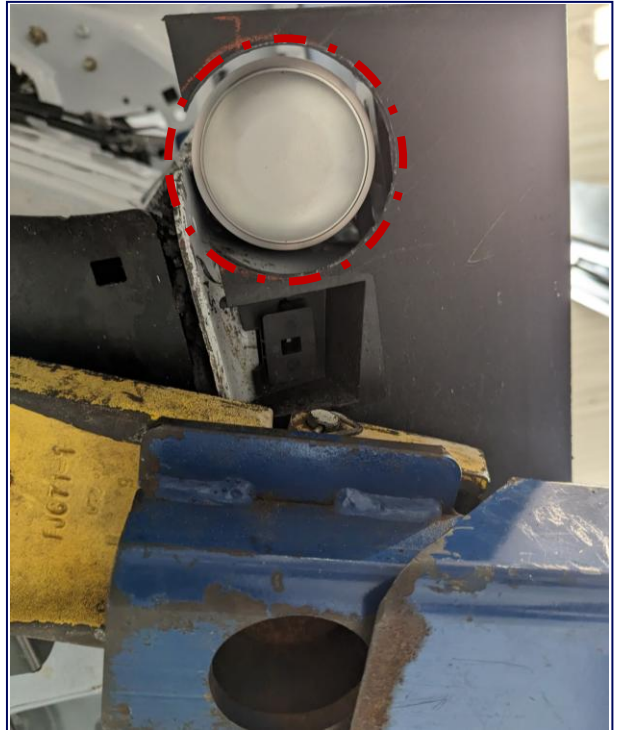

Front Air Jack Side Skirt Modification
Driver Side Shown / Passenger Side Opposite



Rear Air Jack
Driver Side

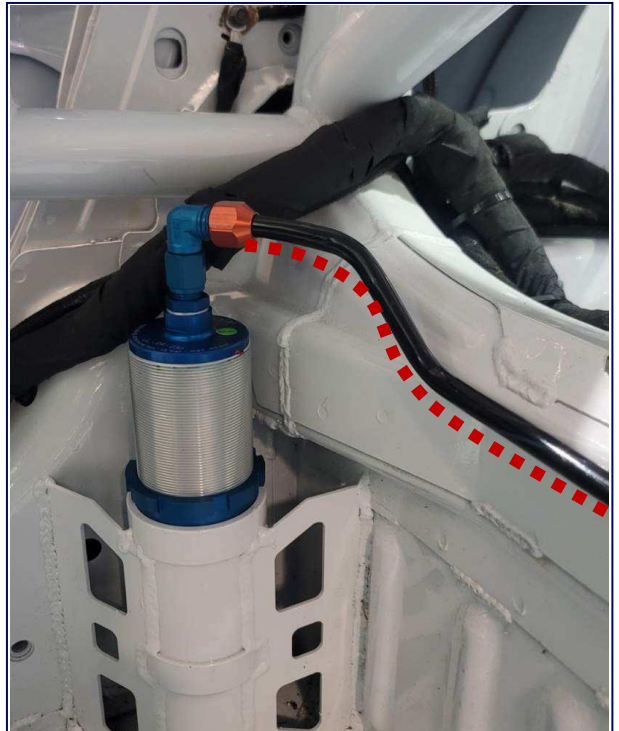

Rear Air Jack
Passenger Side

Air Jack System – Optional

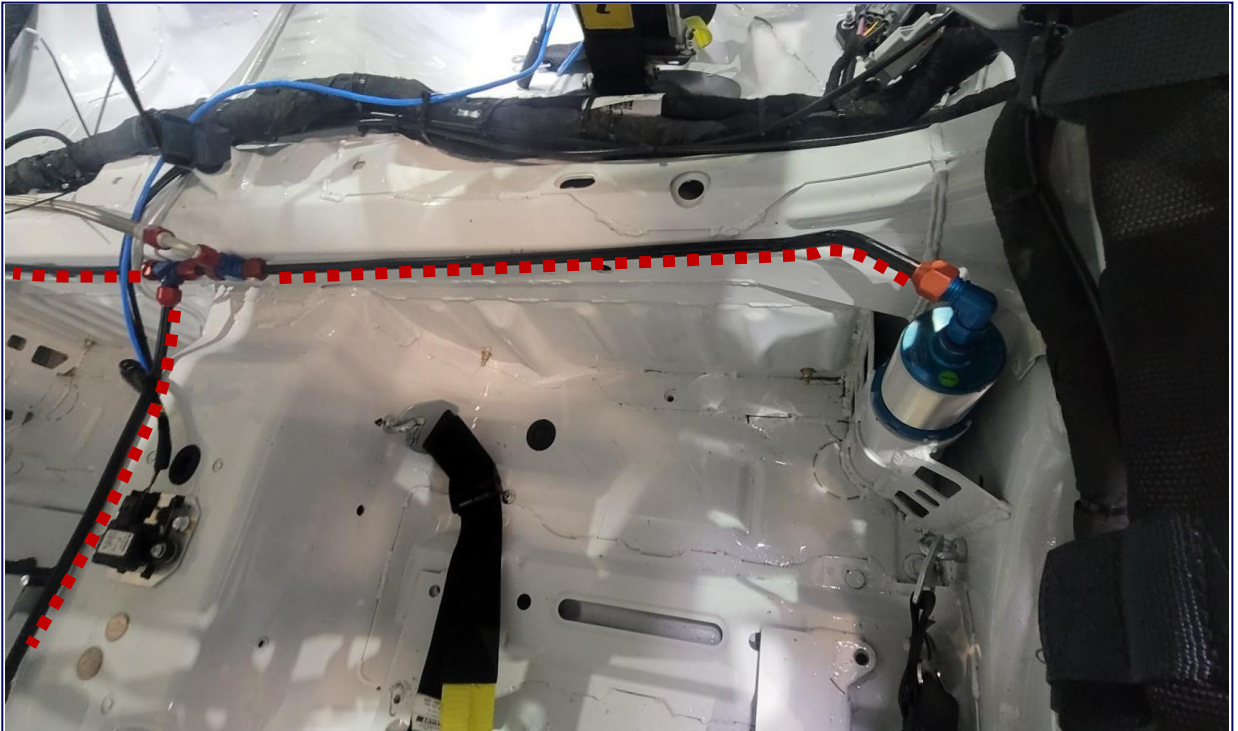

Rear Air Jack / Routing
Driver Side

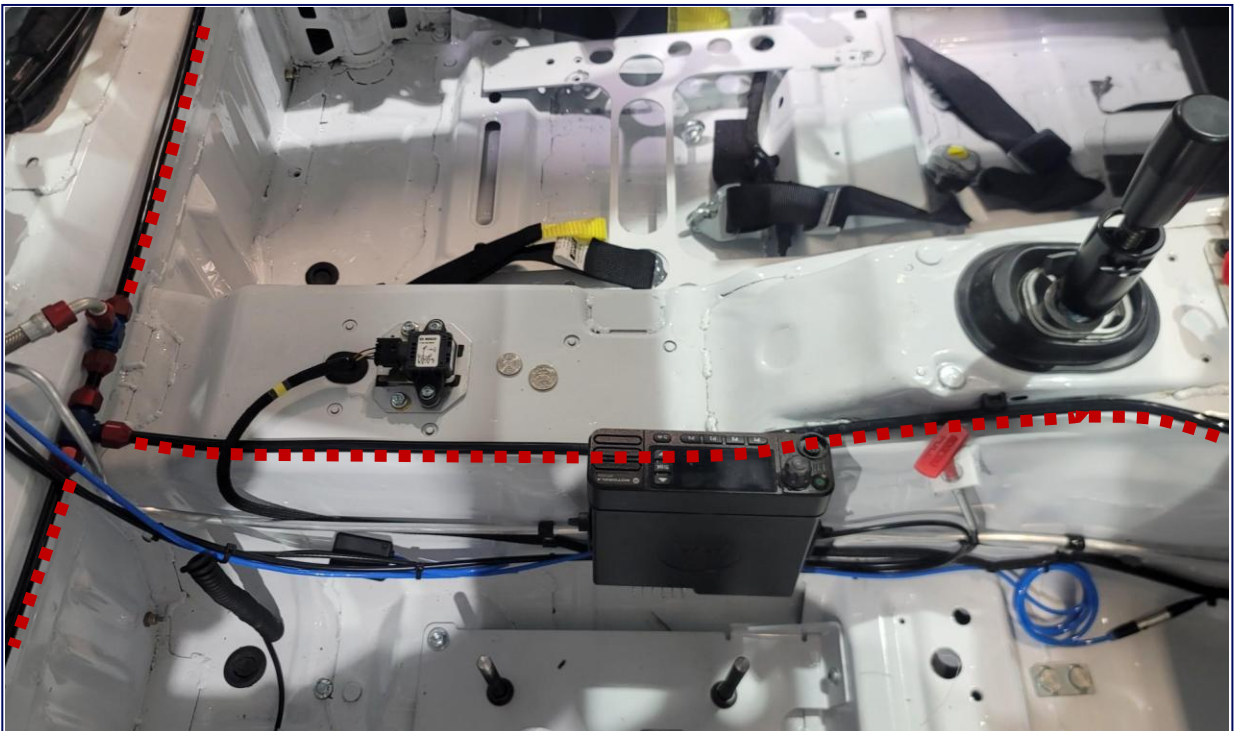

Air Line Routing
Passenger Side of Transmission Tunnel

Air Jack System – Optional

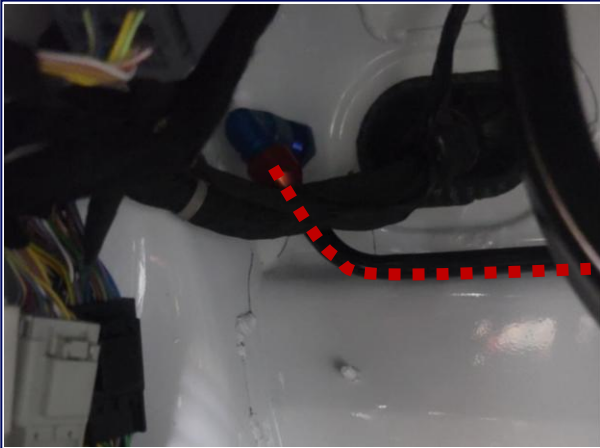

Front Air Jack
Driver Side



Front Air Jack Line Routing
Driver Side

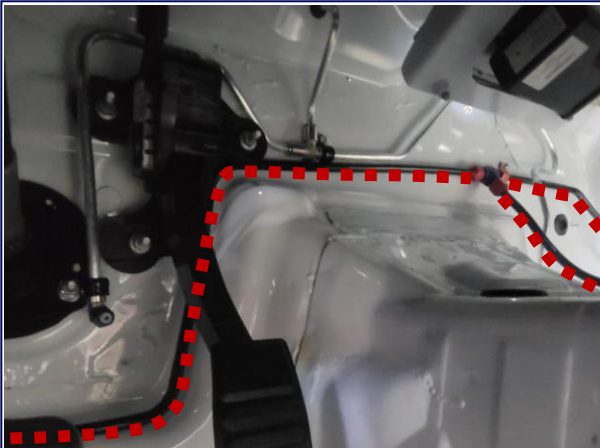

Front Air Jack Line Routing
Driver Side

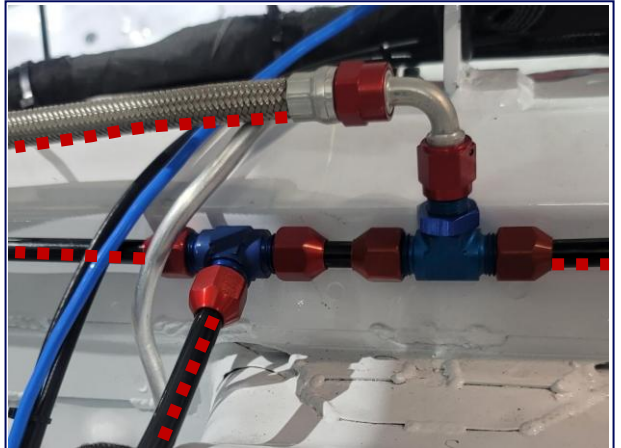

Airline Union to Rear Air Jacks / Air Feed
Line Junction

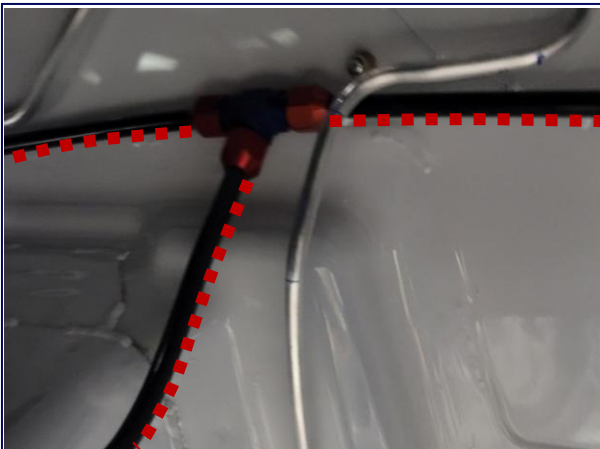

Front Air Jack Union
Union of Passenger Side and Side of Transmission Tunnel

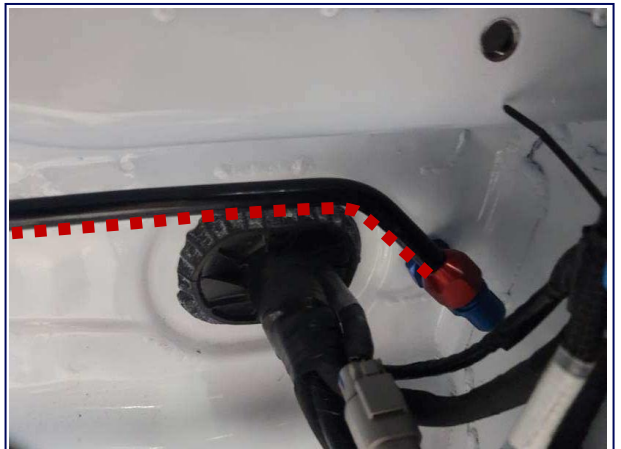

Front Air Jack
Passenger Side

Radio



Radio Location
Right Side of Drive Shaft Tunnel



Radio Mounting Location
(2) M6 Rivnuts Provided



Radio Antenna Location
Driver's Side Roof Panel

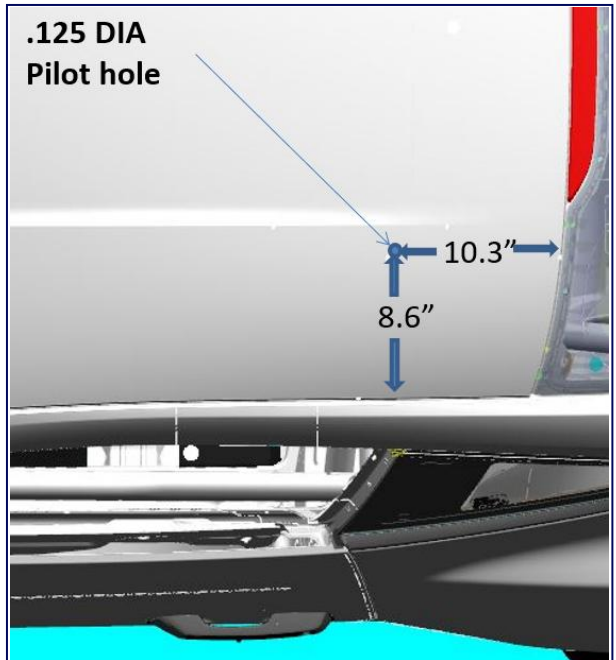

Radio Antenna Location Diagram
(a 1/8" pilot hole is provided)

Yellow Flag Warning System – Mustang Challenge



Light Location
Dash Closeout

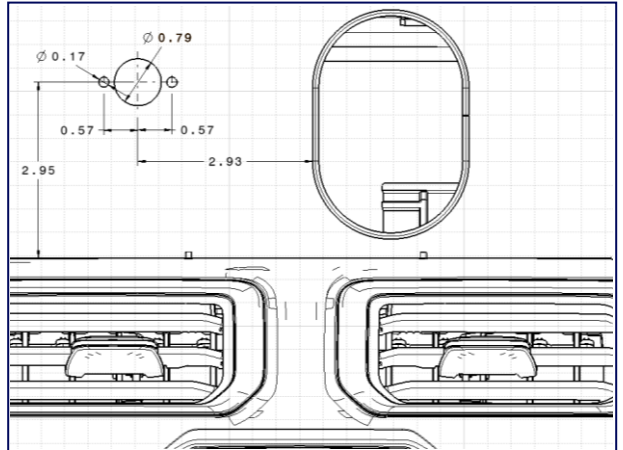

Panel Cut Diagram for Light
(all dimensions are in inches)



Antenna Location
Passenger Side Roof

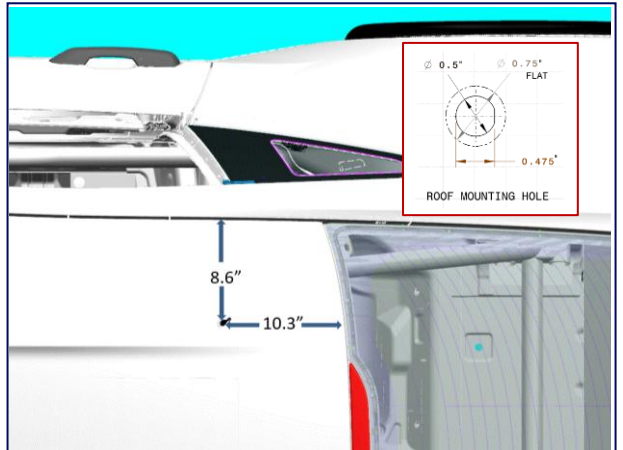

Antenna Location Diagram
(a 1/8" pilot hole is provided)



MSE Box Location
Passenger Side Waterfall

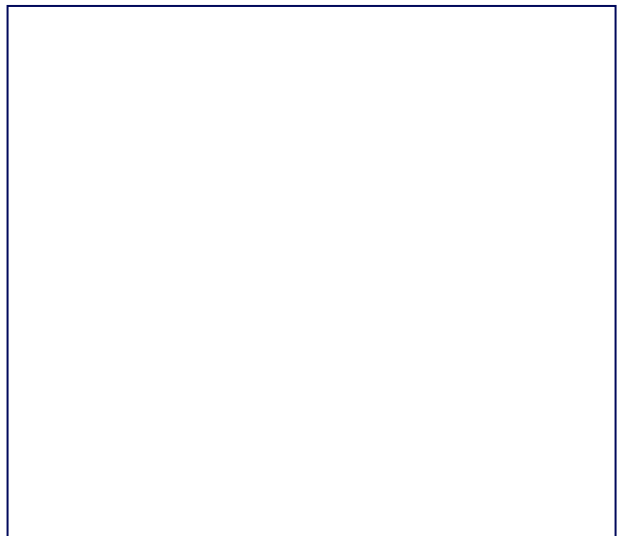

Safety System – Mustang Cup



Safety System Location
Passenger Side Roll Cage

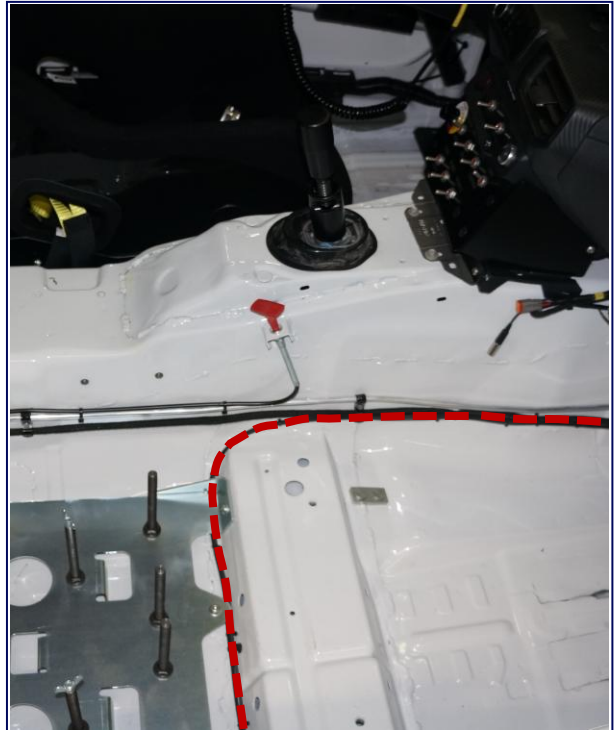

Safety System Routing Location
Passenger Side

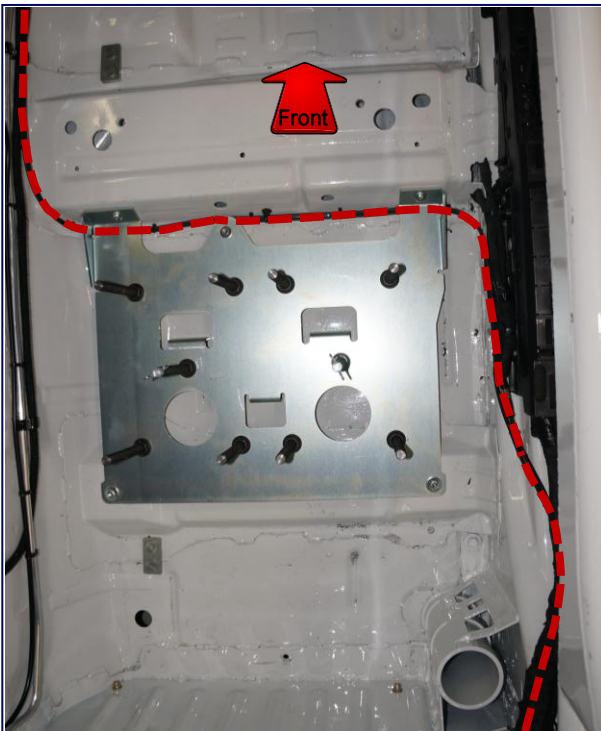

Safety System Routing Location
Passenger Side



Safety System Routing Location
Passenger Side

Safety System – Mustang Cup



Yellow Light Mounting Location
Dash Panel Closeout

Transponder



Transponder Location
Front Passenger Side



Transponder Location



Transponder Bracket Location
Front Passenger Side

Incident Data Recorder

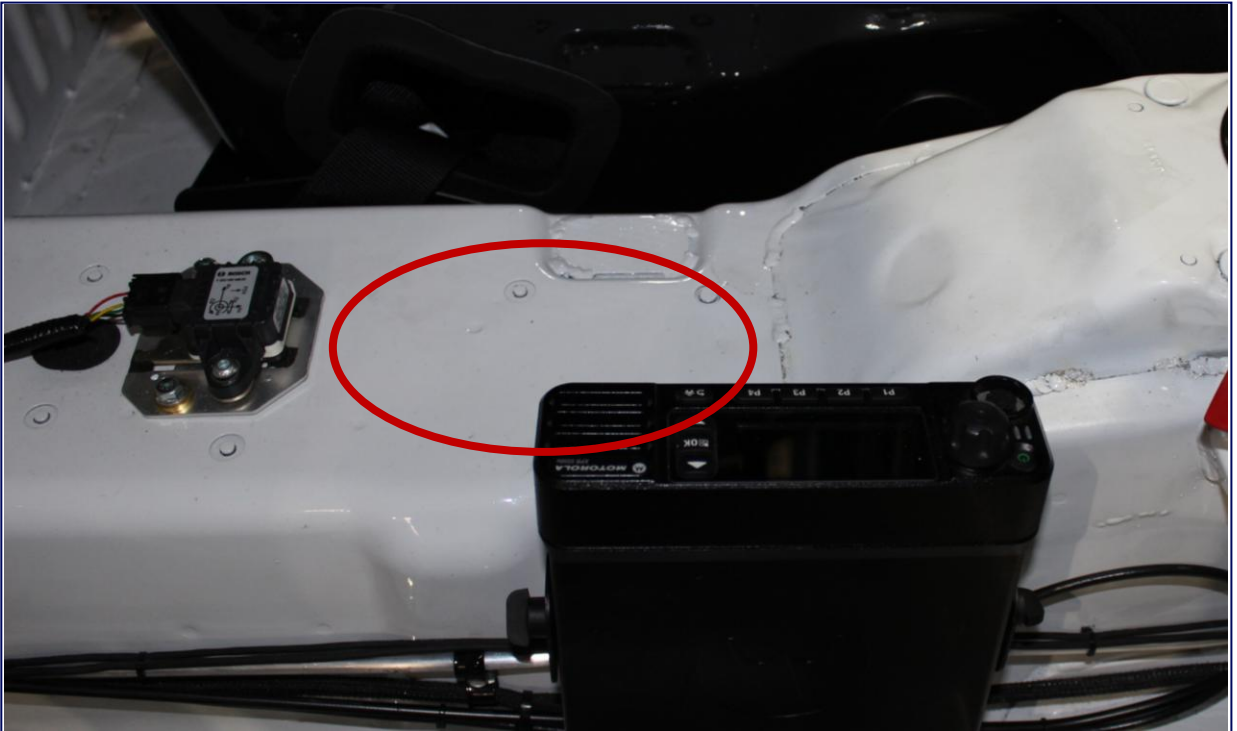

Incident Data Recorder Location
Top of Trans Tunnel

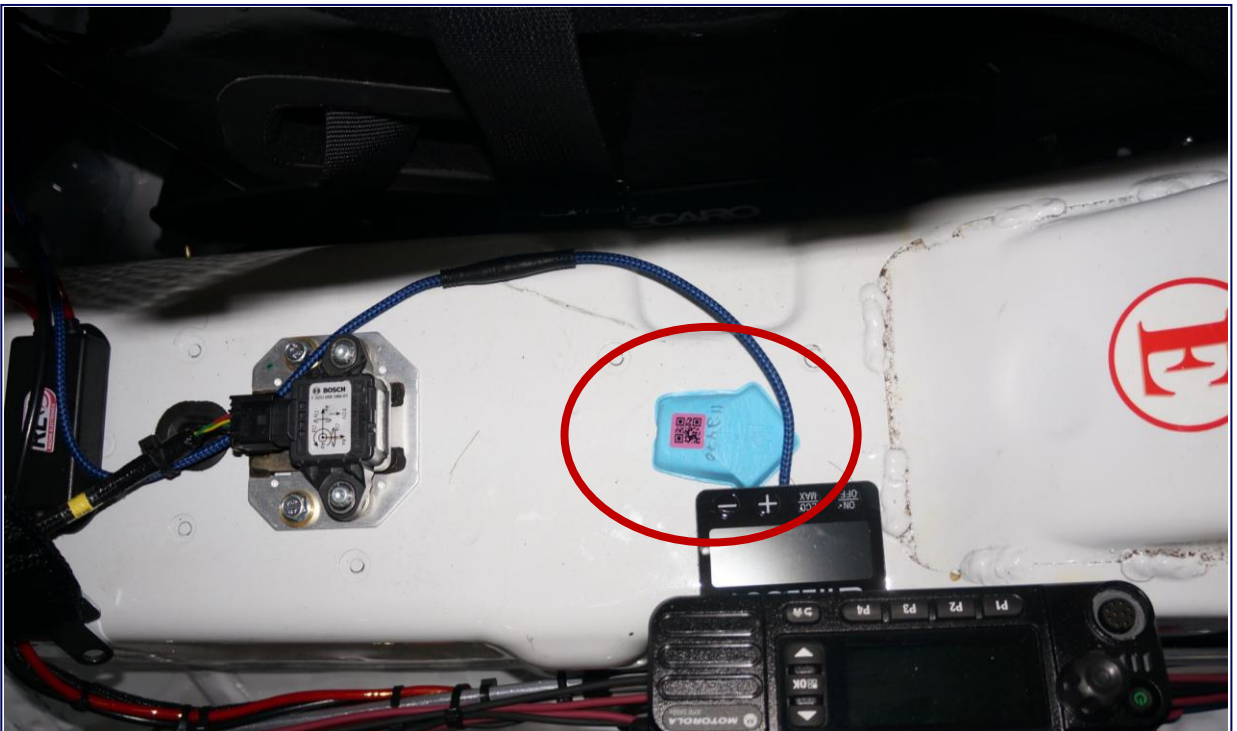

Incident Data Recorder Location
Top of Trans Tunnel

Camera System – Optional for Mustang Challenge VBOX Required for Mustang Cup



VBOX Mount Location Option 1
Passenger Side Roll Cage

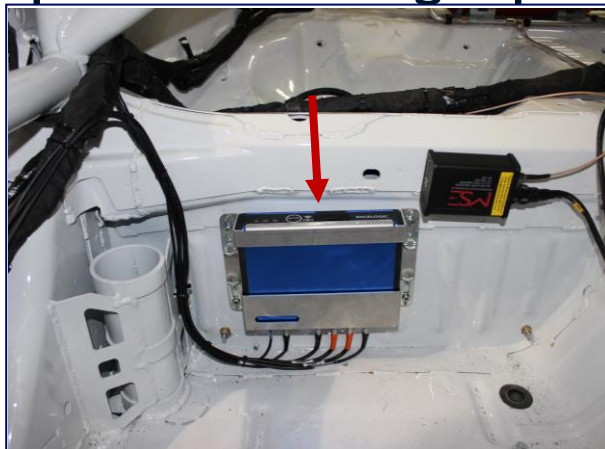

VBOX Mount Location Option 2
Passenger Side Waterfall

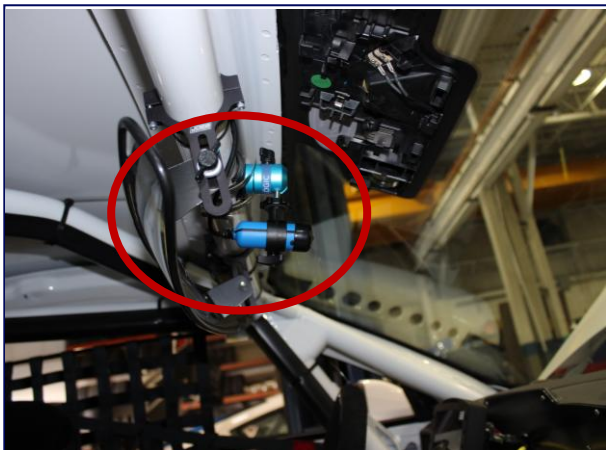

VBOX / GoPro Camera Location 1
Behind Rear View Mirror



VBOX / GoPro Camera Location 2
Passenger Side Roll Cage

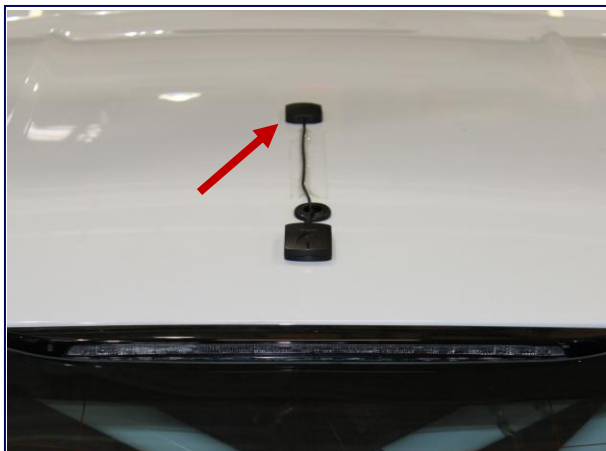

VBOX Antenna Location
Roof Center



VBOX Wiring Labeled "CAN4"
Underneath Dash

Camera System – Optional for Mustang Challenge VBOX Required for Mustang Cup

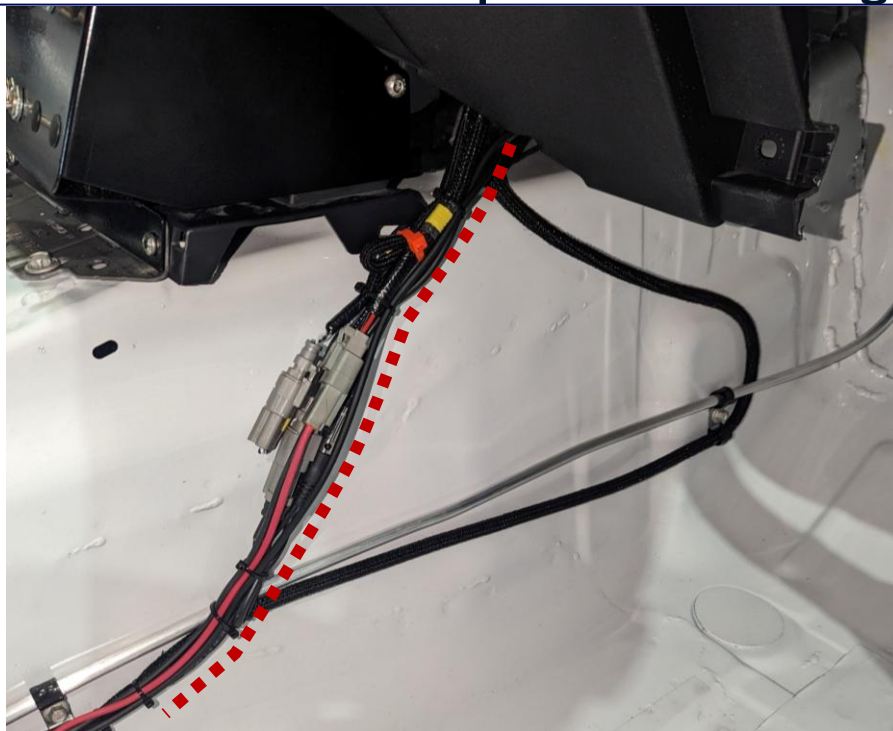

VBOX Harness Routing (Red Dotted Line)

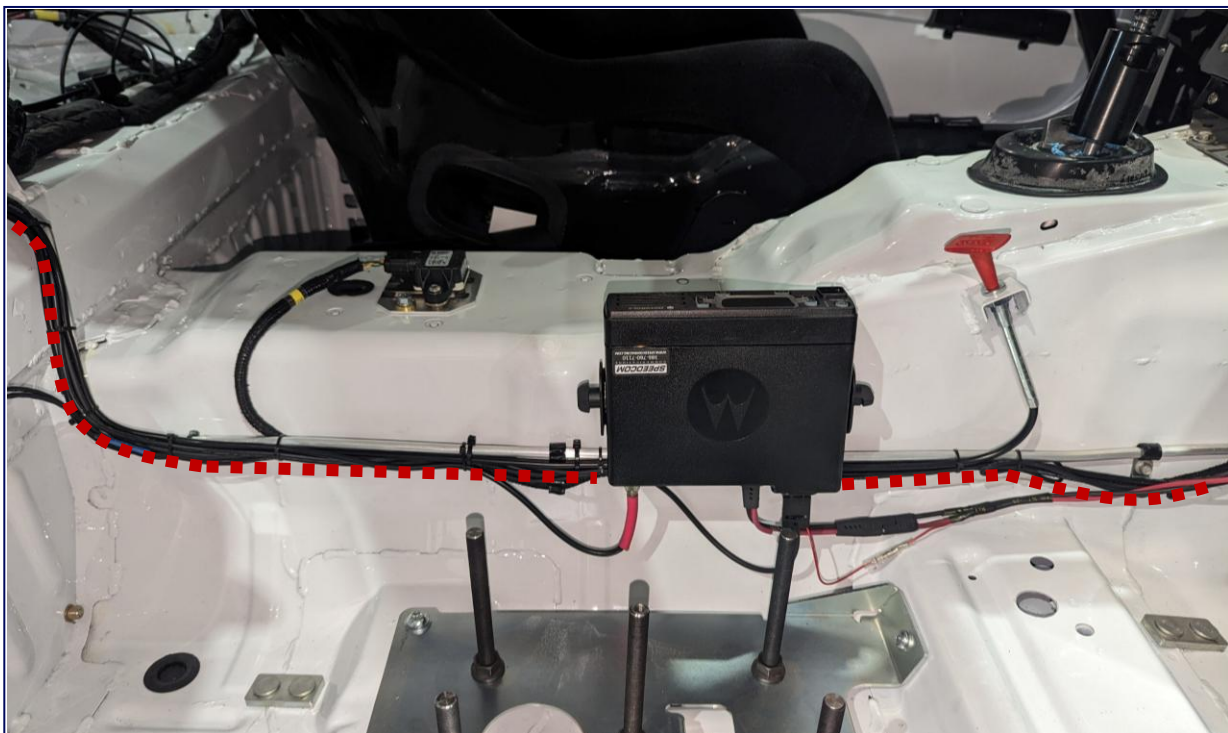

VBOX Harness Routing (Red Dotted Line)

Driver Cooling System



Driver Cooling System Location
Passenger Side Footwell

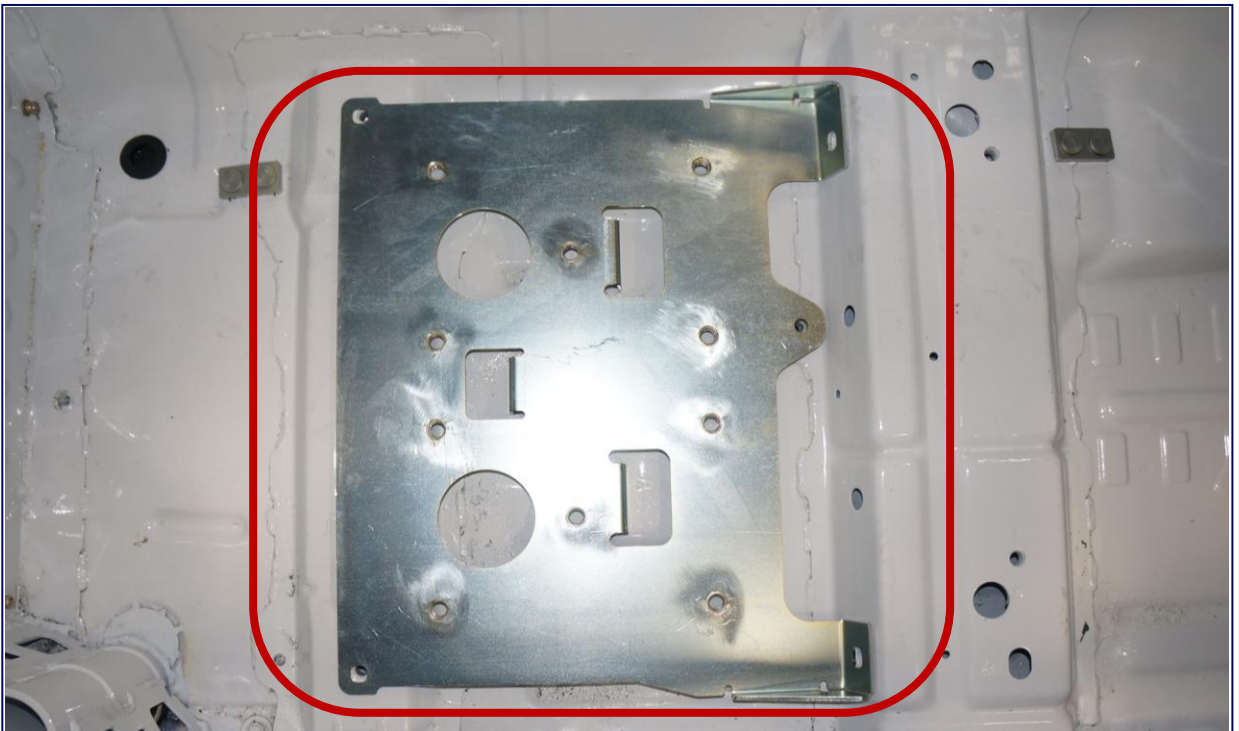

Alternate Driver Cooling System Mount Location – Passenger Side

Customers can use the Ballast Mount plate to mount a Driver Cooling System, or the plate can be removed to use an alternate mounting method

Driver Cooling System



Driver Cooling System Mount* (Optional)
13052-09-1158
Passenger Side Rear Seat
*Mount will be zinc-plated



Driver Cooling System Mount* (Optional)
13052-09-1158
Passenger Side Rear Seat
*Mount will be zinc-plated

Ride Height Reference Points

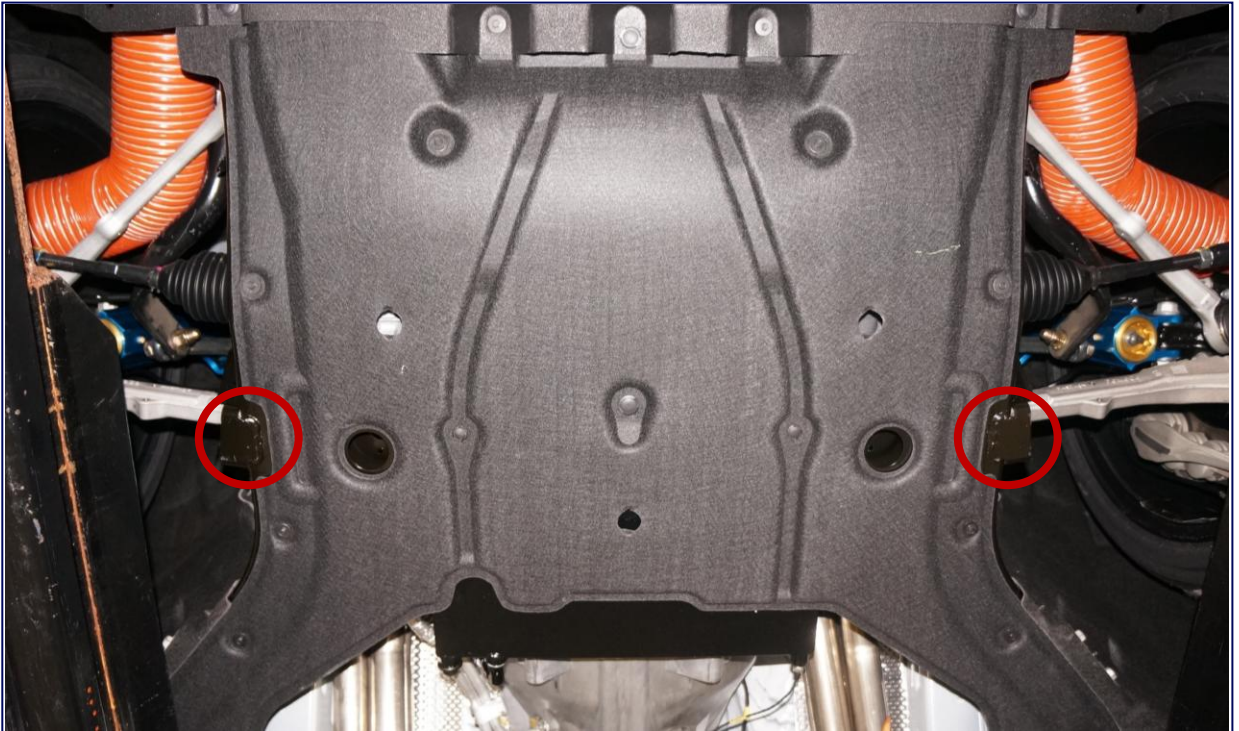

Front Ride Height Reference Points

Engine Service Pigtails



Fuel Injector (Port)
5U2Z-14S411-ZB



Variable Camshaft Timing (VCT) Solenoid
AU2Z-14S411-DB



APP
9U2Z-14S411-BC



Fuel Rail Pressure (Direct)
CU2Z-14S411-AVB



Throttle Position (TP)
AU2Z-14S411-MA



CPP Travel
CU2Z-14S411-AGB



AAT
AU2Z-14S411-AGC



PEM
DU2Z-14S411-CB

Engine Service Pigtails



HP Fuel Pump
EU2Z-14S411-MB



Engine Oil Pressure (EOP)
HU2Z-14S411-BA



CHT
GU2Z-14S411-KA



Intake Manifold Runner Controller (IMRC) Position
HU2Z-14S411-BA



Cam Shaft Position
HU2Z-14S411-BA



Knock Sensor
JU2Z-14S411-TA



Crankshaft Position
HU2Z-14S411-BA



Fuel Rail Pressure/Temp (Port)
JU2Z-14S411-CA

Engine Service Pigtails



MAF/IAT
JU2Z-14S411-ACA



Fuel Injector (Direct) Harness BNK 1 – RH
MU5Z-14A411-LA



MAP
JU2Z-14S411-ACA



Fuel Injector (Direct) Harness BNK 2 – LH
MU5Z-14A411-MA



Ignition Coil
KU2Z-14S411-BA



Cooling Fan Relay Holder
LU2Z-14S411-GA

Bill of Materials

Part Description	Part Number	Qty	Torque Nm	Supplier
Body System	-	-	-	-
BIW Mustang Dark Horse R, Caged and Painted	CFP-607100-DHRCP	1		Technosports
Bodywork Interior	-	-	-	-
Rear View Mirror Kit	JOES-11284	1		HRP
PIA, Mirror	N/A	1		HRP
PIA, Thumb Screw	N/A	2		HRP
PIA, Mounts	N/A	2		HRP
PIA, Screw	N/A	4	0.5	HRP
Dead Pedal Kit	WR-DEADPEDAL	1		Watson
PIA, Mount Bracket	N/A	1		Watson
PIA, Pedal	N/A	1		Watson
Bolt, M6x16	45-20616	5	10	Kimball Midwest
Heat Shield (Driver's Floor)	DHR-FLOOR-HT-SHLD	1		Watson
SS Screw, M6x1	467335	4	10	Kimball Midwest
Dash Panel	-	-	-	-
Main Dash Panel Assembly, Modified	DHR-DASH-MOD	1		Watson
PIA, Main Panel Assembly	N/A	1		Ford Dealer
Bolt, M6x16 (Dash to RH Bracket)	45-20616	4	10	Kimball Midwest
IP Lower Flange (Steel)	PR3Z-63044C52-A	1		Ford Dealer
Bolt / Washer, M6x25	W505425-S450B	4	10	Ford Dealer
Plastic Push Pin, 6.3x2	W711687-S300	1		Ford Dealer
Light Sensor	DG9Z-13A018-AFC	1		Ford Dealer
Center Vents Assembly, Modified	WMOD-C044K30-FB319W	1		Watson
PIA, Center Vents Assembly	PR3Z-63044F58-DA	1		Ford Dealer
Screw, 5x16	W718327-S450B	2	2.5	Ford Dealer
Interior Master Power Panel	DHR-MSTR-PWR-PNL	1		Watson
O-ring, #116	51716	1		Kimball Midwest
PIA, Headlight Switch (PIA Main Panel Assembly)	PR3Z-11654-AA	1		Ford Dealer
Dash Vent LH	PR3Z-63045F20-BA	1		Ford Dealer
Screw, 4.2x19	W718102-S451	1	2.2	Ford Dealer
Dash Vent, RH	PR3Z-6304388-DA	1		Ford Dealer
Dark Horse Name Plate (on RH Dash Vent)	PR3Z-6304338-AH	1		Ford Dealer
Cover, Lower Steering Column LH	PR3Z-6304459-CB	1		Ford Dealer
Cover, Lower Steering Column RH	PR3Z-3530-AB	1		Ford Dealer
Screw, 5x14	W719753-S451	3	1.9	Ford Dealer
Upper Steering Column Shroud, Modified	PR3Z-6304654-BA	1		Ford Dealer
Screw, 4.2x19	W718102-S451	5	2.2	Ford Dealer
Grill Assembly, IP / Defroster Opening	PR3Z-63044E82-AA	1		Ford Dealer
Housing Assembly, IP / Controls	PR3Z-63047A26-BA	1		Ford Dealer
Grill Assembly, IP / Radio	PR3Z-18978-EA	1		Ford Dealer
Panel Assembly, End RH	PR3Z-6304480-AA	1		Ford Dealer
Panel Assembly End LH	PR3Z-6304481-AA	1		Ford Dealer
Dash Panel Closeout	DHR-DASHCLOSEOUT	1		Watson
Button Head Screw, M4-0.7x10	92095A190	6	2.9	McMaster Carr
Button Head Screw, M6-1.0x10	92095A224	2	10	McMaster Carr
Bodywork Exterior	-	-	-	-
Hood	PR3Z-16612-B	1		Ford Dealer
Fender RH	PR3Z-16005-B	1		Ford Dealer
Fender LH	PR3Z-16006-B	1		Ford Dealer
Door RH	PR3Z-6320124-A	1		Ford Dealer
Door LH	PR3Z-6320125-A	1		Ford Dealer
Deck Lid	PR3Z-6340700-B	1		Ford Dealer
Hood Strut RH	PR3Z-16C826-A	1		Ford Dealer
Hood Strut LH	PR3Z-16C826-B	1		Ford Dealer
Hood Side Seal RH	PR3Z-16A238-A	1		Ford Dealer

Bill of Materials (Cont.)

Part Description	Part Number	Qty	Torque Nm	Supplier
Hood Side Seal LH	PR3Z-16A239-A	1		Ford Dealer
Hood Front Seal	FR3Z-16740-A	1		Ford Dealer
Hood Seal (Front Side Panel) RH	JR3Z-16B990-A	1		Ford Dealer
Hood Seal (Front Side Panel) LH	JR3Z-16B991-A	1		Ford Dealer
Hood Scoop	PR3Z-16C630-BAPTM	1		Ford Dealer
Nut / Washer, M4	W701567-S450B	4	5.4	Ford Dealer
Hood Pins, Modified	DHR-HODDPIN-MOD	1		Watson
PIA, Hood Pins	ACH-120-4000	1		HRP
Rivnut, M4x0.7	85411	12		Kimball Midwest
Bumper (Hood Stop)	5R3Z-16758-AA	2		Ford Dealer
Bracket (Rocker Panel to Fender) RH	PR3Z-16A076-C	1		Ford Dealer
Bracket (Rocker Panel to Fender) LH	PR3Z-16A076-D	1		Ford Dealer
Rear Lower Molding Retain RH	PR3Z-6329074-B	1		Ford Dealer
Plastic Nut, 5.4mm	F5RZ-17K657-A	3		Ford Dealer
Screw / Washer, 6.3x25	W701107-S450B	3	3.2	Ford Dealer
Rear Lower Molding Retain LH	PR3Z-6329075-B	1		Ford Dealer
Plastic Nut, 5.4mm	F5RZ-17K657-A	3		Ford Dealer
Screw / Washer, 6.3x25	W701107-S450B	3	3.2	Ford Dealer
Core Support	PR3Z-8A284-A	1		Ford Dealer
Bolt / Washer, M8x25	W711806-S450B	4	20	Ford Dealer
Bolt / Washer, M8x45	W714182-S442	4	20	Ford Dealer
U-Nut Clip, M6x0.8-4.0	W520822-S439	6		Ford Dealer
Wiper Motor Assembly	FR3Z-17508-B	1		Ford Dealer
Bolt / Washer, M6x35	W707532-S442	3	9	Ford Dealer
Wiper Arm RH	FR3Z-17526-B	1		Ford Dealer
Wiper Arm LH	FR3Z-17527-B	1		Ford Dealer
Nut / Washer, M10	W716490-S450B	2	35	Ford Dealer
Rubber Cap, 15x13	W710461-S300	2		Ford Dealer
Hood Air Deflector	PR3Z-16A238-C	1		Ford Dealer
Plastic Push Rivet, 6x2.5-6	W705436-S300	8		Ford Dealer
Heat Shield (Footwell / Underside) RH	FR3Z-6310062-A	1		Ford Dealer
Heat Shield (Footwell / Underside) LH	FR3Z-6310063-A	1		Ford Dealer
Nut / Washer, M6 (Heat Shield to Body)	W718611-S900	5	10	Ford Dealer
Battery Tray, Modified	DHR-BATBOX-MOD	1		Watson
PIA, Battery Tray	PR3Z-10732-A	1		Ford Dealer
Bolt, M6x24 (Battery Tray to Hold Down)	W713219-S439	5	10.5	Ford Dealer
U-Nut Clip, M6x0.8-4.0	W520812-S439	1	10	Ford Dealer
Battery Tie Down	6F2Z-10756-A	1	8	Ford Dealer
Rocker Panel RH	PR3Z-6310176-AAPTM	1		Ford Dealer
Rocker Panel LH	PR3Z-6310177-AAPTM	1		Ford Dealer
PIA, Push Pin (Bottom of Rocker into Body)	W707889-S300	16		Ford Dealer
Rocker Panel Front Scuff	PR3Z-6313208-AB	2		Ford Dealer
C-Bracket (Bottom of K-Frame)	PR3Z-5025-A	1		Ford Dealer
Bolt, M10x30 (Bracket to K-Frame)	W718025-S439	6	62.5	Ford Dealer
Expansion Clip Nut (Blue), 4.2mm	W716529-S900	2		Ford Dealer
Rear Deflector, Modified	DHR-AIRDEFLECTR-MOD	1		Watson
PIA, Rear Deflector	KR3Z-6P013-B	1		Ford Dealer
Bolt / Washer, M8x25	W711806-S450B	2	30	Ford Dealer
Screw / Washer, 4.2x20	W716345-S450B	5	1.5	Ford Dealer
Bolt / Washer, M8x25	W711806-S450B	2	9	Ford Dealer
Front Fender Splash Shield RH	PR3Z-16102-D	1		Ford Dealer
Front Fender Splash Shield LH	PR3Z-16103-D	1		Ford Dealer
Screw / Washer, 4.2x25	W715060-S450B	4	2.2	Ford Dealer
Plastic Push Rivet, M8x27	W707373-S300	4		Ford Dealer
Plastic Push Rivet, 6.5x2-4.5	W713610-S300	20		Ford Dealer

Bill of Materials (Cont.)

Part Description	Part Number	Qty	Torque Nm	Supplier
Plastic Push Rivet, 6.5x4.5-7	W714040-S300	4		Ford Dealer
Frame Side Member RH	PR3Z-5050-A	1		Ford Dealer
Frame Side Member LH	PR3Z-5051-A	1		Ford Dealer
Bolt, M10x30	W718025-S439	8	62.5	Ford Dealer
Expansion Clip Nut (Blue), 4.2mm	W716529-S900	2		Ford Dealer
Engine Splash Pan (Underbody)	PR3Z-6775-A	1		Ford Dealer
Screw / Washer, 4.2x25	W715060-S450B	13	2.2	Ford Dealer
Plastic Push Pin, 7.6x20	W709371-S300	2		Ford Dealer
Expansion Clip Nut (Blue), 4.2mm	W716529-S900	11		Ford Dealer
Radiator Air Deflector	PR3Z-8310-H	1		Ford Dealer
Screw / Washer, 4.2x25	W715060-S450B	22	2.2	Ford Dealer
Expansion Clip Nut (Blue), 4.2mm	W716529-S900	4		Ford Dealer
Plastic Push Pin	W714975-S300	3		Ford Dealer
PIA, Nut Spring	N/A	12		Ford Dealer
Fender Emblem Dark Horse	PR3Z-16228-B	2		Ford Dealer
Decklid Emblem Dark Horse	PR3Z-6342528-J	1		Ford Dealer
Tow Hook Kit, Front	FP-17654-FDH	1		Watson
PIA, Tow Hook	N/A	1		Watson
Flat Washer, M10	453510	2		Kimball Midwest
Nylock Nut, M10-1.5	46-5510	2	35	Kimball Midwest
Bolt, M10-1.5x160	91280A670	2		McMaster Carr
Aluminum Spacer, 1" x 1"	92510A826	2		McMaster Carr
Tow Hook Kit, Rear	FP-17954-RDH	1		Watson
PIA, Tow Hook	N/A	1		Watson
PIA, Side Plate	N/A	2		Watson
Fender Washer, 3/8"x1-3/4"	10594	1		Kimball Midwest
Nylock Nut, M10x1.5	46-5510	3	35	Kimball Midwest
Flange Bolt, M10x70	4521070	3	35	Kimball Midwest
Tie Down Kit (Includes Front & Rear Hooks with Hardware)	M-1700-M	1		Ford Performance Parts
PIA, Tie Down, Front	N/A	2		Ford Performance Parts
PIA, Tie Down, Rear	N/A	2		Ford Performance Parts
PIA, Bolt, M10-1.5x35	N/A	8	74	Ford Performance Parts
Plug, 19x25	W706010-S300	1		Ford Dealer
Plug, 36x0.8-1.5	W711539-S300	3		Ford Dealer
Plug, 30x0.6-1.5	W702351-S300	2		Ford Dealer
Plug, 25.5x1.8	W703638-S300	2		Ford Dealer
Plug, 19x25	W706010-S300	1		Ford Dealer
Cover Plate (Rubber)	F65Z-7K540-AA	2		Ford Dealer
Front Fascia	-	-	-	-
Front Fascia Assembly	FP-17000-DHR	1		Ford Dealer
Front Bumper Beam	PR3Z-17757-A	1		Ford Dealer
Panel Grill Opening	PR3Z-8190-BA	1		Ford Dealer
Front Fascia - Front Bumper Cover	PR3Z-17D957-CAPTM	1		Ford Dealer
Screw, 5x16	W506843-S450B	7		Ford Dealer
Seal (Fascia to Hood)	PR3Z-16A238-B	1		Ford Dealer
Grill (Upper)	PR3Z-8200-DAPTM	1		Ford Dealer
Upper Grill Mesh Insert	DHR-MESHGRL-UPR	1		Technosports
Lower Grill, Modified	DHR-GRLLWR-MOD	1		Watson
PIA, Lower Grill	PR3Z-17K945-EAPTM	1		Ford Dealer
Screw / Washer, 4.2x20	W716345-S450B	4	2.2	Ford Dealer
Lower Grill Mesh Insert	DHR-MESHGRL-LWR	1		Technosports

Bill of Materials (Cont.)

Part Description	Part Number	Qty	Torque Nm	Supplier
Grill Assembly (Lower) RH	PR3Z-17B968-DAPTM	1		Ford Dealer
Grill Assembly (Lower) LH	PR3Z-17E811-DBPTM	1		Ford Dealer
Bumper Isolator Assembly, Modified	DHR-GRILLUPR-MOD	1		Watson
PIA, Isolator Front Bumper	PR3Z-17C882-C	1		Ford Dealer
Duct, to Trans Cooler (Lower Grill RH)	PR3Z-8310-J	1		Ford Dealer
Duct, to Oil Cooler (Lower Grill) LH	PR3Z-8311-F	1		Ford Dealer
Front Tow Hook Opening Cover	PR3Z-17E811-B	1		Ford Dealer
Trim (Lower Fascia) RH	PR3Z-17E810-AAPTM	1		Ford Dealer
Trim (Lower Fascia) LH	PR3Z-17E811-AAPTM	1		Ford Dealer
Screw / Washer, 4.2x20	W716345-S450B	2	2.2	Ford Dealer
Front Fascia Mounting Bracket	PR3Z-17C897-A	1		Ford Dealer
Bolt / Washer, M6x20	W705134-S450B	6	4.8	Ford Dealer
Front Splitter Assembly	PR3Z-17626-AA	1		Ford Dealer
Screw / Washer, 4.2x20	W716345-S450B	2	2.2	Ford Dealer
Splitter Pencil Rod	LCR-DH-PENCIL	2		Capaldi Racing
Rubber Washer	93650A350	2		McMaster Carr
Splitter Support	LCR-DHR-SPLTR	1		Capaldi Racing
Splitter Bumper Bracket	LCR-DHR-BMPR-BRKT	2		Capaldi Racing
Grill Cowl Top Assembly, Modified	DHR-COWEL-MOD	1		Watson
PIA, Grill Assembly Cowl Top Vent (Deleafeer)	PR3Z-63022A68-AA	1		Ford Dealer
Plastic Push Rivet, 8.5x7	W718365-S300	4		Ford Dealer
Nylon Push Pin, 6.8x19.8	W706815-S300	1		Ford Dealer
Grommet, 9.25x0.8-2.25	W709629-S300	1		Ford Dealer
Air Intake Duct LH	PR3Z-8311-G	1		Ford Dealer
Air Intake Duct RH	PR3Z-8310-K	1		Ford Dealer
Brake Duct Mounting Bracket Kit	DHR-BRK-DCT-MNT-BRKT	1		Watson
PIA, Brake Duct Bracket Upper	N/A	2		Watson
PIA, Brake Duct Bracket Lower	N/A	2		Watson
Rivet, 1/4"	PR42-SSP	16		Kimball Midwest
Brake Duct Hose Kit	LCR-DH-BHKA	1		Capaldi Racing
PIA, Hose	N/A	2		Capaldi Racing
PIA, Clamp	N/A	4		Capaldi Racing
Brake Duct Inlet Kit	LCR-DH-BDK	1		Capaldi Racing
PIA, RH Inlet	N/A	1		Capaldi Racing
PIA, LH Inlet	N/A	1		Capaldi Racing
Radiator Closeout Kit	DHR-RADCLOSEOUT	1		Watson
PIA, Rad Shroud Closeout LH	N/A	1		Watson
PIA, Rad Shroud Closeout RH	N/A	1		Watson
PIA, Rad Shroud Closeout Middle	N/A	1		Watson
PIA, Rad Shroud Cover Top	N/A	1		Watson
PIA, Fan Shroud Cover Top	N/A	1		Watson
PIA, Rad Shroud Panel Lower	N/A	1		Watson
PIA, Rad Duct Support	N/A	1		Watson
Rivet, 1/4"	PR42-SSP	38		Kimball Midwest
Clip-on Gasket, 185"	12335A42	1		McMaster Carr
Nylock Nut, M6-1.0	46-5506	2	10	Kimball Midwest
Grommet	9307K217	2		Kimball Midwest
Hex Flange Bolt, M6x25	45-20625	4	10	Kimball Midwest
Rivnut, M6-1.0	85413	8		Kimball Midwest
Screw / Washer (Self-Tapping), M6x18	W705968-S439	8	10	Ford Dealer
Trunk/ Rear	-	-	-	-
Vent, Under Rear Fascia	3C3Z-54280B62-DA	2		Ford Dealer
Trunk Seal (Rubber)	FR3Z-6343720-A	1		Ford Dealer
Deck Lid Strut	PR3Z-63406A10-C	2		Ford Dealer
Bracket (Rear Closeout) RH	FR3Z-17D942-G	1		Ford Dealer
Bracket (Rear Closeout) LH	FR3Z-17D943-H	1		Ford Dealer

Bill of Materials (Cont.)

Part Description	Part Number	Qty	Torque Nm	Supplier
Bolt / Washer, M6x25	W711158-S442	2	10.5	Ford Dealer
U-Nut Clip, M6x0.8-4.0	W520812-S439	2		Ford Dealer
Wing	PR3Z-6344210-EC	1		Ford Dealer
Bolt / Washer, M6x13	W722355-S442	2	8	Ford Dealer
Decklid Panel	PR3Z-6344210-BDPTM	1		Ford Dealer
Screw / Washer, 4.2x20	W716345-S450B	4	2.5	Ford Dealer
Nut / Washer, M6	W520521-S442	5	5.4	Ford Dealer
Bolt / Washer, M6x13	W722355-S442	2	5.4	Ford Dealer
Wing Wicker	DHR-WING-EXTEN	1		Watson
Striker (Inside Trunk to Body)	AH6Z-5443252-A	1		Ford Dealer
Bolt / Washer, M6x18	W505423-S307	2	10	Ford Dealer
Latch (Deck Lid to Striker), Modified	WMOD-7643282-BB	1		Watson
PIA, Latch (Deck Lid to Striker)	FR3Z-7643200-B	1		Ford Dealer
Nut / Washer, M6	W520521-S442	3	10	Ford Dealer
Trunk Release Cable	MA014RL24CL	1		Sparco SPA
P-Clamp, 1/4"	26461	3		Kimball Midwest
Bolt, M6x16	W505253-S450L	3		Ford Dealer
Crimp Joint	3883T22	1		McMaster Carr
Shrink Tube, 0.5" long	269821	2		Kimball Midwest
Luggage Compartment Door Bumper	PR3Z-7840452-A	2		Ford Dealer
Rear Closeout	DHR-REARCLOSEOUT-AS	1		Watson
PIA, Closeout Lower	N/A	1		Watson
PIA, Closeout Upper	N/A	1		Watson
PIA, Grommet Plate	N/A	1		Watson
Grommet, 3/8" ID	26-814	1		Kimball Midwest
Grommet, 5/16" ID	26-810	1		Kimball Midwest
Grommet, 1" ID	9307K74	1		McMaster Carr
Grommet, 1/4" ID	26-808	1		Kimball Midwest
Rivet, 3/16"	48-3620	4		Kimball Midwest
Rivet, 1/4"	PR42-SSP	26		Kimball Midwest
Rear Fascia	-	-	-	-
Rear Fascia Assembly	FP-17500-DHR	1		Ford Dealer
Rear Bumper Beam	FR3Z-17906-A	1		Ford Dealer
Rear Bumper Isolator	PR3Z-17E855-C	1		Ford Dealer
Rear Fascia Bracket, to Body (Corner Mount Under Tail Light) RH	PR3Z-17C947-C	1		Ford Dealer
Rear Fascia Bracket, to Body (Corner Mount Under Tail Light) LH	PR3Z-17E855-A	1		Ford Dealer
Rear Fascia	PR3Z-17K835-AAPT	1		Ford Dealer
Screw / Washer, 4.2x20	W716345-S450B	2	2.2	Ford Dealer
Screw / Washer, 4.2x25	W715060-S450B	8	2.2	Ford Dealer
Plastic Push Rivet, 6.5x4.5-7	W714040-S300	4		Ford Dealer
Nut Expansion-White	W719745-S300	2		Ford Dealer
Rear Fascia Bracket, to Body (Center Mount)	PR3Z-17754-AA	1		Ford Dealer
Screw / Washer, 4.8x19	W700092-S450	4	1.9	Ford Dealer
Nut Expansion-Blue	W721035-S439	4		Ford Dealer
Screw / Washer, 4.8x19	W700092-S450	6	1.9	Ford Dealer
Nut Expansion-Blue	W721035-S439	6		Ford Dealer
Rear Fascia Bracket, to Body (Side Mount) RH	PR3Z-17D942-C	1		Ford Dealer
Rear Fascia Bracket, to Body (Side Mount) LH	PR3Z-17D943-C	1		Ford Dealer
Screw / Washer, 4.8x19	W700092-S450	10	1.9	Ford Dealer
Nut Expansion-Blue	W721035-S439	10		Ford Dealer
Rear Fascia Bracket, to Body (Lower Mount) RH	PR3Z-17D942-A	1		Ford Dealer
Rear Fascia Bracket, to Body (Lower Mount) LH	PR3Z-17D943-A	1		Ford Dealer
Screw / Washer, 4.8x19	W700092-S450	4	1.9	Ford Dealer
Nut Expansion-Blue	W721035-S439	4		Ford Dealer

Bill of Materials (Cont.)

Part Description	Part Number	Qty	Torque Nm	Supplier
Marker Light RH	PR3Z-15A101-A	1		Ford Dealer
Marker Light LH	PR3Z-15A201-E	1		Ford Dealer
Rear Lower Valance	PR3Z-17F828-EA	1		Ford Dealer
Screw / Washer, 4.2x20	W716345-S450B	6	2.2	Ford Dealer
Plastic Push Rivet, 6.5x4.5-7	W714040-S300	4		Ford Dealer
Reflector RH	JR3Z-15A448-A	1		Ford Dealer
Reflector LH	JR3Z-15A449-A	1		Ford Dealer
Door	-	-	-	-
Striker	JX7Z-5822008-B	2		Ford Dealer
Striker Pad	JX7Z-58218K02-A	2		Ford Dealer
Bolt, M8x27 (Striker to Body)	W717729-S437M	4	20	Ford Dealer
Front Door Glass Frame & Molding Assembly RH	PR3Z-63214A62-A	1		Ford Dealer
Front Door Glass Frame & Molding Assembly LH	PR3Z-63214A63-A	1		Ford Dealer
Bolt / Washer, M6x14	W706069-S442	4	9	Ford Dealer
Bolt, M6x17	W703429-S450	2	9	Ford Dealer
Latch Assembly RH	N/A	1		Ford Dealer
Reinforcement	PR3Z-6326684-A	1		Ford Dealer
Link	PR3Z-6322152-A	1		Ford Dealer
Latch	NB5Z-5821812-A	1		Ford Dealer
Shield	PR3Z-3621978-A	1		Ford Dealer
Door Latch LH	DHR-DOORLTCHCABL	1		Watson
Latch Assembly LH	N/A	1		Ford Dealer
Link	PR3Z-6322152-A	1		Ford Dealer
Reinforcement	PR3Z-6326685-A	1		Ford Dealer
Latch	NB5Z-5821813-A	1		Ford Dealer
Shield	PR3Z-3621979-A	1		Ford Dealer
Plug Button, 19x0.7	W718717-S300	2		Ford Dealer
Bolt, M6x13 (Latch to Door)	W715340-S450B	6	8	Ford Dealer
P-Clamp, 1/4"	26-461	1		Kimball Midwest
Nylock Nut, M6-1.0	46-5506	1	10	Kimball Midwest
Bolt, M10-1.0	241958	1	10	Kimball Midwest
Handle (Door) RH	PR3Z-6322404-AA	1		Ford Dealer
Handle (Door) LH	PR3Z-6322405-AA	1		Ford Dealer
Mirror Assembly RH	PR3Z-17682-H	1		Ford Dealer
Mirror Assembly LH	PR3Z-17683-H	1		Ford Dealer
Bolt / Washer, M6x20	W716914-S307	4	9	Ford Dealer
Nut / Washer, M6	W710771-S442	2	9	Ford Dealer
Mirror Cover RH	FR3Z-17D742-AAPTM	1		Ford Dealer
Mirror Cover LH	FR3Z-17D743-AAPTM	1		Ford Dealer
Bezel (Door Lock) RH	PR3Z-63218A14-A	2		Ford Dealer
Weatherstrip - Front Door Glass at Belt Outside RH	PR3Z-6321452-A	1		Ford Dealer
Weatherstrip - Front Door Glass at Belt Outside LH	PR3Z-6321453-A	1		Ford Dealer
Weatherstrip - Front Door RH	PR3Z-6320530-A	1		Ford Dealer
Weatherstrip - Front Door LH	PR3Z-6320531-A	1		Ford Dealer
Weatherstrip - Front Body Pillar RH	PR3Z-6302564-B	1		Ford Dealer
Weatherstrip - Front Body Pillar RH	PR3Z-6302564-A	1		Ford Dealer
Screw (Torx Head), 4.2x13	W711129-S450B	12	1	Ford Dealer
Expansion Nut - Yellow, M4.2	W703027-S300	12		Ford Dealer
PIA, Pin	N/A	1		Ford Dealer
Weatherstrip - Front Body Pillar LH	PR3Z-6302565-B	1		Ford Dealer
Weatherstrip - Front Body Pillar LH	PR3Z-6302565-A	1		Ford Dealer
Screw (Torx Head), 4.2x13	W711129-S450B	12	1	Ford Dealer
Expansion Nut - Yellow, M4.2	W703027-S300	12		Ford Dealer
PIA, Pin	N/A	1		Ford Dealer

Bill of Materials (Cont.)

Part Description	Part Number	Qty	Torque Nm	Supplier
Foam (LH Door) (Impaxx 300)	DHR-IMPAXX-LH-FOAM	1		Watson
Panel (Covers Foam Inside Door)	DHR-INNR-DOOR-PNL	1		Watson
Rivet, 1/8"	PR3Z-SSP	15		Kimball Midwest
Glass	-	-	-	-
Quarter Window RH	PR3Z-6329710-A	1		Ford Dealer
Quarter Window LH	PR3Z-6329711-A	1		Ford Dealer
Rear Window	PR3Z-6342006-A	1		Ford Dealer
Windshield	PR3Z-6303100-B	1		Ford Dealer
Windo-Weld (Urethane) (Glass Installation)	051135-08609	4		R.S. Hughes
Primer	051135-08681	0.25		R.S. Hughes
Engine	-	-	-	-
Sealed Engine	FP-6007-DHR	1		Technosports
Service Engine	N/A	1		Technosports
Cap, Oil 5W-50	F2GE-6766-EC	1		Ford Dealer
Oil Pan Drain Bolt	64-216	1		Kimball Midwest
Bolt, Crankshaft Damper	BR3E-6A340-AA	1		Ford Performance Parts
Vacuum Hose Cap (on Intake)	64087	1		Kimball Midwest
Oetiker Clamp, 14.5mm	16700013	1		Grainger
Insulator (Engine Mount to K-Member)	MR3Z-6038-A	2		Ford Dealer
Bolt / Washer, M10x46 (Insulator to K-Member) (Blue Loctite)	W713078-S439	4	62.5	Ford Dealer
Nut (Engine to Insulator), M10	W712530-S440	2	62.5	Ford Dealer
Bracket (Mount to Engine Block) RH	BR3Z-6028-C	1		Ford Dealer
Bolt, M10x55 (Bracket to Block)	W500723-S439	3	62.5	Ford Dealer
Bracket (Mount to Engine Block) LH	BR3Z-6031-C	1		Ford Dealer
Stud, M10x55+M10x20 (Bracket to Block)	W714924-S900	1	62.5	Ford Dealer
Bolt, M10x55 (Bracket to Block)	W500723-S439	4	62.5	Ford Dealer
Starter Motor	PR3Z-11002-B	1		Ford Dealer
Bolt, M10x80	W714012-S439	1	47.5	Ford Dealer
Stud, M10x42+M8x16	W715721-S437	1	47.5	Ford Dealer
Nut / Washer, M6	W716298-S450	1	6.2	Ford Dealer
Nut / Washer, M8	W711953-S900	2	12	Ford Dealer
Air Box / Zip Tube Assembly LH, Modified	WMOD-9C662-BP	1		Watson
Modified Air Cleaner	DHR-AIRTUBE-MOD	1		Watson
PIA, Air Box / Zip Tube Assembly LH	PR3Z-9600-G	1		Ford Dealer
Bolt / Washer, M6x40	W505428-S442	1	8	Ford Dealer
Vacuum Cap, 5/8"	660-1696	1		NAPA
Oetiker Clamp, 23.5mm	16700028	1		Grainger
Element Assy- Air Filter	PR3Z-9601-A	-		Ford Dealer
Air Box / Zip Tube Assembly RH, Modified	WMOD-9C662-CP	1		Watson
Modified Air Cleaner	DHR-AIRTUBE-MOD	1		Watson
PIA, Air Box / Zip Tube Assembly RH	PR3Z-9600-J	1		Ford Dealer
Bolt / Washer, M6x40	W505428-S442	1	8	Ford Dealer
Duct - Air Cleaner (Connects to Airbox) RH	PR3Z-9C675-B	1		Ford Dealer
Duct - Air Cleaner (Connects to Airbox) LH	PR3Z-9C675-A	1		Ford Dealer
Air Box Bracket, Connects to Fuse Panel Bracket	PR3Z-9647-A	1		Ford Dealer
U-Nut Clip, M6x0.8-4.0	W520802-S439	6		Ford Dealer
Bolt / Washer, M6x25	W505425-S442	5	8	Ford Dealer
Air Box Bracket	PR3Z-9647-B	1		Ford Dealer
U-Nut Clip, M6x0.8-4.0	W520802-S439	3		Ford Dealer
Bolt / Washer, M6x20	W505424-S439	3	8	Ford Dealer
Fuel Pump Shield	JR3Z-9A397-B	1		Ford Dealer
Fuel Injector Insulator	JR3Z-9K540-F	1		Ford Dealer
Bolt / Washer, M8x80	W719295-S450	1	30	Ford Dealer
Tensioner	JR3Z-6B209-A	1		Ford Dealer

Bill of Materials (Cont.)

Part Description	Part Number	Qty	Torque Nm	Supplier
Bolt, M10x70	W709638-S439	1	47.5	Ford Dealer
Belt	PR3Z-8620-C	1		Ford Dealer
Oil Cooler (Setrab, M22)	SET50-960-7612	1		HRP
Adapter, M22-AN12	SET22-M22AN12-SE	2		HRP
Screw / Washer (Self-Tapping), M6x18 (Oil Cooler to Shroud)	W705968-S439	8	10	Ford Dealer
Oil Cooler Lines Kit	DHR-OIL-CLR-LINES	1		Watson
PIA, Engine Out / Cooler In	S650-DHR-OIL-LINE1A	1		Watson
PIA, Cooler Out / Engine In	S650-DHR-OIL-LINE2A	1		Watson
P-Clamp, 1"	26-478	1		Kimball Midwest
Washer, M6	453506	2		Kimball Midwest
Nylock Nut, M6x1.0	46-5506	1	10	Kimball Midwest
Button Head Screw, M6-1.0x20	96452A723	1	10	McMaster Carr
Oil Fitting Adapters Kit	LCR-OCA-12	1		Capaldi Racing
Catch Can, -10 AN	PTR08-0400-FPR	1		Watson
Vent Hose, Short RH	PVC-SHORT-HOSE-ASSY	1		Watson
Vent Hose, Long LH	PVC-LONG-HOSE-ASSY	1		Watson
Bracket, Catch Can	PVC-TRNS-VNT-BRKT	1		Watson
PCV Vacuum Line Connector	7T4Z-9E499-B	2		Ford Dealer
Vent Fitting 90 Degree	7T4Z-9E499-B	2		Ford Dealer
Fitting (on Oil Pan, Connects to Catch Can Drain back Hose)	989006	1		XRP Inc
Bolt / Washer, M6x20	W505424-S442	2	6.2	Ford Dealer
Bolt / Washer, M6x16	W505253-S450L	2	10	Ford Dealer
P-Clamp, 1/2"	26464	1		Kimball Midwest
Catch Can to Oil Pan Drain Back Hose	CAT-CAN-DRN-BCK	1		Watson
Filter Assy - Oil Filter	AA5Z-6714-A	-		Ford Dealer
Cooling	-	-	-	-
Tank Assembly (Radiator Supply)	PR3Z-8A080-A	1		Ford Dealer
Bolt / Washer, M6x20	W721207-S442	2	8	Ford Dealer
Stud / Washer, M6x20	W719496-S442	1	8	Ford Dealer
U-Nut Clip, M6x0.8-4.0	W520802-S439	1		Ford Dealer
Cap (Tank Assembly)	DG9Z-8100-A	1		Ford Dealer
Hose Assembly (Rad Over Flow)	PR3Z-8075-K	1		Ford Dealer
Upper Hose Assembly (Rad to Engine)	PR3Z-8260-B	1		Ford Dealer
Fan Motor / Shroud	PR3Z-8C607-A	1		Ford Dealer
Bolt / Washer, M6x20 (Shroud to Rad)	W505424-S442	2	6.2	Ford Dealer
Radiator Assembly	CR-CC-Y1196-002	1		Technosports
Lower Radiator Aluminum Hose	FP-8286-A	1		Technosports
Lower Radiator Soft Hose, 5.5" (Inlet to Thermostat Housing)	HRP-SAM-FP-8286-B	1		Technosports
Lower Radiator Soft Hose, 4.5" (Radiator Side)	HRP-SAM-FP-8286-C	1		Technosports
Hose Clamp OD 35-45mm	HRP-SAM-HCB45	4		Technosports
Zip Tie Stud Mount	157-00291	1		Technosports
Insulator (Lower Rad Support in K-Frame)	XW4Z-8124-AA	2		Ford Dealer
Bracket (Upper Rad Support to Core Support)	JR3Z-8A193-A	2		Ford Dealer
Bolt / Washer, M6x25 (Bracket to Core Support)	W505425-S450B	4	10.5	Ford Dealer
Hose Assembly - Engine Cooler Reservoir	PR3Z-8075-J	1		Ford Dealer
Heater Bypass Hose	WR-18K580-MODA	1		Watson
Fitting (90deg) and Clamp	PR3Z-18472-S	1		Ford Dealer
Hose, 3/4" (6')	H152	1		NAPA
P-clamp, 1"	26-478	2		Kimball Midwest
Hose - Radiator Supply Tank	PR3Z-8A365-CA	1		Ford Dealer
Exhaust System	-	-	-	-
Rear Hanger RH	JR3Z-5260-A	1		Ford Dealer

Bill of Materials (Cont.)

Part Description	Part Number	Qty	Torque Nm	Supplier
Rear Hanger LH	JR3Z-5277-A	1		Ford Dealer
Bolt / Washer, M8x26 (Hanger to Body)	W718205-S439	4	25	Ford Dealer
Exhaust Hanger (to Rear Sub-Frame)	FR3Z-5A242-E	2		Ford Dealer
U-Nut Clip, M8	W709990-S439	2		Ford Dealer
Bolt, M8x25	W712977-S439	2	30	Ford Dealer
Exhaust Gasket LH	GR3Z-9448-C	1		Ford Dealer
Exhaust Gasket RH	FR3Z-9448-A	1		Ford Dealer
Full Exhaust	FP-5200-DHR	1		Borla
PIA, RH Tail Pipe	FP-5200-DHRRT	1		Borla
PIA, LH Tail Pipe	FP-5200-DHRLT	1		Borla
PIA, X-Pipe	FP-5200-DHRX	1		Borla
PIA, RH Collector Pipe	FP-5200-DHRRC	1		Borla
PIA, LH Collector Pipe	FP-5200-DHRLC	1		Borla
PIA, Clamp	N/A	6		Borla
Exhaust Wrap, 2"x50'	THT-11002	1		HRP
Headers Kit	FP-9430-DHR	1		Borla
RH Header	FP-9430-DHRR	1		Borla
LH Header	FP-9430-DHRL	1		Borla
Header Bolt, M10x1.25x25	454633	16	32	Kimball Midwest
Fuel System	-	-	-	-
Fuel Supply Tube to Engine	PR3Z-9J280-J	1		Ford Dealer
Fuel Door	PR3Z-63405A26-A	1		Ford Dealer
Housing (Fuel Tank Filler)	PR3Z-6327936-A	1		Ford Dealer
Fuel Cell Bladder Assembly	LCR-DH-FUELCELL	1		Capaldi Racing
Fuel Cell Fill Plate	N/A	1		Capaldi Racing
PIA, Bolt	N/A	24	3.5	Capaldi Racing
Fuel Pump	NR3Z-9350-A	1		Ford Dealer
Plate (Fuel Pump Block Off)	DHR-FUELPMPBLKOFF	2		Watson
Rivet, 1/8"	PR4Z-SSP	8		Kimball Midwest
Grommet, 5/8" ID	26-822	2		Kimball Midwest
Fuel Cell Spacer and Lid Kit	DHR-FUEL-SPACER	1		Watson
Bolt, M4-0.7x16	M04CM016KBFAS7380FLZB	24	2.2	Global Fastener
PIA, Lid	N/A	1		Watson
PIA, Spacer	N/A	1		Watson
Fuel Vent Hose	DHR-FUELVENTHOSE	1		Watson
-6 Hose, 94.5" long	AR-06-P	1		Watson
Fitting, -6 Straight	AC-06-F4	1		Watson
P-Clamp, 1/2"	26464	5		Kimball Midwest
Shrink Tube 3/4", 1.5" long	26994	1		Kimball Midwest
Bolt, M6-1.0x16	4520616	4	10	Kimball Midwest
Grommet, 5/8"	26-822	1		Kimball Midwest
Rivnut, M6-1.0	85413	4		Kimball Midwest
Bracket, Dry Break	DHR-DRY-BRKT	1		Watson
Washer, M5	454505	2		Kimball Midwest
Nylock Nut, M5-0.8	46-5505	2	4	Kimball Midwest
Screw, M5x12	463271	2	4	Kimball Midwest
Fuel Lines and Fittings Kit	DHR-FUEL-LINES	1		Watson
Factory to Bulkhead	S650-DHR-FUEL-LINE1	1		Watson
Bulkhead to Quick Release	S650-DHR-FUEL-LINE2	1		Watson
Quick Release to Cell	S650-DHR-FUEL-LINE3	1		Watson
Fuel Supply Tube Assembly, Modified	WMOD-9J280-DC	1		Watson
PIA, Fuel Supply Tube Assembly	PR3Z-9J280-D	1		Ford Dealer
Ball Locking Break Socket (Red)	STA-SPT08.3655/L/JKV	1		HRP
Ball Locking Break Plug (Red)	STA-SPT08.7655/L/JKV	1		HRP
Fitting, -6AN Male Bulkhead to -6FM outlet (Black)	GEN-GA3186	1		HRP

Bill of Materials (Cont.)

Part Description	Part Number	Qty	Torque Nm	Supplier
Chassis System	-	-	-	-
Damper Assembly, Front LH/RH	FP-18000F-DHR	1		Technosports
Damper Assembly, Rear LH/RH	FP-18000R-DHR	1		Technosports
PIA, Damper Canister Mounting Clips	086-007	4		Technosports
Camber Plate, LH	FR-18183L-DHR	1		Multimatic
Camber Plate, RH	FR-18183R-DHR	1		Multimatic
Rivet, 3/16"	POPSSD62SSBS	8		Reid
Frame & Mounting System	-	-	-	-
K Member, Modified	WMOD-5C145-A	1		Watson
PIA, K Member	PR3Z-5C145-A	1		Ford Dealer
Bolt / Retainer, M12x121 (K Member, Back)	W711810-S439	4	115	Ford Dealer
Bolt / Retainer, M12x144 (K Member, Front)	W711805-S439	4	115	Ford Dealer
Plastic Push Pin, 10x28.3 (K Member)	W706358-S300	8		Ford Dealer
Bolt / Washer, M12x59 (K Member)	W717325-S439	4	115	Ford Dealer
Nut, K Member, M12	W707246-S440	8	115	Ford Dealer
Expansion Clip Nut (Blue), 4.2mm	W716529-S900	15		Ford Dealer
U-Nut Clip, M6x0.8-4.0	W520812-S439	2		Ford Dealer
Rear Subframe, Modified	DHR-SUBFRAME-MOD	1		Watson
Bushing Kit (Diff)	DHR-4425-M	1		Watson
Bushing Kit (Body)	DHR-5872-M	1		Watson
Bracket (Body to Subframe) LH	FR3Z-5077-A	1		Ford Dealer
Bracket (Body to Subframe) RH	FR3Z-5084-A	1		Ford Dealer
Bolt, M10x35 (Bracket to Body)	W506435-S439	4	55	Ford Dealer
Bolt / Washer, M14x120 (Subframe to Body)	W717827-S900	4	175	Ford Dealer
Bolt, M12x35	W718383-S439	4	103	Ford Dealer
Bearing Kit for Front & Rear Control Arms	SBK-60-1000	1		Cortex
PIA, Front Bearing RH / LH	N/A	2		Cortex
PIA, Front Bearing Spacers	N/A	4		Cortex
PIA, Front Bearing Inserts	N/A	2		Cortex
PIA, Front Bearing Clip, Insert	N/A	2		Cortex
PIA, Rear Bearing RH / LH	N/A	2		Cortex
PIA, Rear Bearing Spacers	N/A	4		Cortex
PIA, Rear Bearing Inserts	N/A	2		Cortex
PIA, Rear Bearing Clip, Insert	N/A	2		Cortex
Front Suspension	-	-	-	-
Knuckle Assembly RH (S550)	NR3Z-3K185-A	1		Ford Dealer
Knuckle Assembly LH (S550)	NR3Z-3K186-A	1		Ford Dealer
Front Knuckle Backing Plate	DHR-FT-BEAR-CV	2		Watson
Hub / Bearing Assembly	PR3Z-1109-D	2		Ford Dealer
Bolt, M14x62.5	W721525-S439	8	150	Ford Dealer
Bolt, M16x72	W715932-S439	4	250	Ford Dealer
Nut, M16	W520517-S450	4	250	Ford Dealer
Front Wheel Stud, M14x85	10-0119	10		Ford Performance Parts
Nut, M14	40-0001-B	10	122	Ford Performance Parts
Arm RH - Lower Front Assembly	DHR-FCNTRLBRNG-MODR	1		Watson
PIA, Arm RH - Lower Front	PR3Z-3082-B	1		Ford Dealer
Bolt, M16x92 (Green Loctite)	W711479-S439	1	250	Ford Dealer
Bolt, M16x117	W710755-S439	1	250	Ford Dealer
Nut, M14	W520215-S440	2	103	Ford Dealer
Arm LH - Lower Front Assembly	DHR-FCNTRLBRNG-MODL	1		Watson
PIA, Arm LH - Lower Front	PR3Z-3083-B	1		Ford Dealer
Bolt, M16x92 (Green Loctite)	W711479-S439	1	250	Ford Dealer
Bolt, M16x117	W710755-S439	1	250	Ford Dealer
Nut, M14	W520215-S440	2	103	Ford Dealer

Bill of Materials (Cont.)

Part Description	Part Number	Qty	Torque Nm	Supplier
Arm RH - Lower Lateral	PR3Z-3078-B	1		Ford Dealer
Arm LH - Lower Lateral	PR3Z-3079-B	1		Ford Dealer
Bolt / Washer, M12x40 (for ARB)	W717732-S439	4	110	Ford Dealer
Adjustable Link (Front Anti Roll Bar)	DHR-FRTSWYBRLINK-AS	1		Watson
Nylock Nut, 7/16-20	34-8507	2	81	Kimball Midwest
Nylock Nut, 1/2-20	34-8508	2	108	Kimball Midwest
Washer, 1/2"	373908	2		Kimball Midwest
Cap Screw, 7/16-20x2	390716	2	81	Kimball Midwest
Cap Screw, 1/2-20x2.5	390820	2	108	Kimball Midwest
Anti Roll Bar, Front	FR3Z-5482-J	1		Ford Dealer
Bushing for Anti Roll Bar, Front	FR3Z-5484-C	2		Ford Dealer
Clamp (Anti Roll Bar to K-Frame)	FR3Z-5486-A	2		Ford Dealer
Bolt / Washer, M12x40 (Clamp To K-Frame)	W717732-S439	4	110	Ford Dealer
Spring, Front	HYP187B0700	2		HRP
Spring Bearing Kit, Front (2.5")	GEN-GC1015	2		HRP
Bolt, M16x72 (Damper to Knuckle)	W715932-S439	4	250	Ford Dealer
Nut, Damper to Knuckle	W520517-S450	4	250	Ford Dealer
Bracket Assembly, Front ABS Wire	DHR-FRT-ABS-WRBRKT	2		Watson
PIA, Front ABS Wire Bracket	N/A	1		Watson
Screw, M6x20	W505424-S442	4	6.2	Ford Dealer
X-Tree Tie Mount	T-50RTM	2		Kimball Midwest
Rear Suspension	-	-	-	-
Lower Control Arm RH	DHR-RCNTRLBRNG-MODR	1		Watson
PIA, Lower Control Arm RH	PR3Z-5500-D	1		Ford Dealer
Bolt, M16x97	W716992-S439	1	225	Ford Dealer
Bolt, M16x114	W717065-S439	1	250	Ford Dealer
Lower Control Arm LH	DHR-RCNTRLBRNG-MODL	1		Watson
PIA, Lower Control Arm LH	PR3Z-5500-E	1		Ford Dealer
Bolt, M16x97	W716992-S439	1	225	Ford Dealer
Bolt, M16x114	W717065-S439	1	250	Ford Dealer
Rear Upper Camber Arm, RH	200171-12-1016	1		Multimatic
Bolt / Washer, M12x104	W716795-S439	1	115	Ford Dealer
Nut, M12x1.75 (to Subframe)	W520214-S440	1	115	Ford Dealer
Bolt, M12x75	HM14AU70-5C	1	132	ARP
Nut, M12	AUN12-3	1	132	ARP
Rear Upper Camber Arm, LH	200171-12-1017	1		Multimatic
Bolt / Washer, M12x104	W716795-S439	1	115	Ford Dealer
Nut, M12x1.75 (to Subframe)	W520214-S440	1	115	Ford Dealer
Bolt, M12x75	HM14AU70-5C	1	132	ARP
Nut, M12	AUN12-3	1	132	ARP
Vertical Link (Knuckle to Lower Control Arm)	PR3Z-5A972-A	2		Ford Dealer
Bolt, M14x82	W716342-S439	2	175	Ford Dealer
Bolt / Washer, M12x104 (to Knuckle)	W716795-S439	2	103	Ford Dealer
Nut / Retainer, M12 (to Knuckle)	W715682-S900	2	103	Ford Dealer
Knuckle / Bearing Assembly RH, Modified	CM-5B758-S650	1		Watson
PIA, Knuckle Assembly RH	PR3Z-5B758-B	1		Ford Dealer
Bolt, M16x112 (to Lower Control Arm)	W717821-S439	1	275	Ford Dealer
Bearing (Toe Link Kit with 2 bearings)	M-5A460-M	1		Ford Performance Parts
Knuckle / Bearing Assembly LH, Modified	CM-5B759-S650	1		Watson
PIA, Knuckle Assembly LH	PR3Z-5B759-B	1		Ford Dealer
Bolt, M16x112 (to Lower Control Arm)	W717821-S439	1	275	Ford Dealer
Hub / Bearing Assembly	FR3Z-1104-G	2		Ford Dealer
Bolt, M12x58 (to Knuckle)	W718188-S439	8	115	Ford Dealer

Bill of Materials (Cont.)

Part Description	Part Number	Qty	Torque Nm	Supplier
Rear Wheel Stud & Nut Kit	M-1107-E	1		Ford Performance Parts
Stud, M14x54	10-0042	10		Kimball Midwest
Nut, M14	40-0001-B	10	122	Kimball Midwest
Rear Upper Shock Mount	DHR-RUPRSHKMOUNT	2		Watson
PIA, Bushing	N/A	4		Watson
Bolt, M12x35 (Mount to Body)	W718383-S439	4	103	Ford Dealer
Washer	37-3907	4		Kimball Midwest
Rear Lower Shock Mount, Top	LCR-LSBRKT-DH	2		Capaldi Racing
Washer	37-3907	4		Kimball Midwest
Rear Lower Shock Mount, Bottom	DHR-RLOWERSHKMNT	2		Watson
Bolt, 3/8-24x2-1/2"	39-0620	2	61	Kimball Midwest
Lock Nut, 3/8-24	348506	2	61	Kimball Midwest
Lock Nut, 7/16-20	348507	2	81	Kimball Midwest
Flat Washer, 3/8 SAE Grade 8	373906	4		Kimball Midwest
Flat Washer, 7/16 SAE Grade 8	373907	4		Kimball Midwest
Bolt, 7/16-20x2-1/2 SAE Grade 8	390716	2	81	Kimball Midwest
Spacer, Diameter 0.625"x0.125"	S650-DHR-SHOCK-MOUNT-SPACER	2		Watson
Toe Link Assembly Kit (Adjustable)	DHR-TOE-LINK-ASSY-R2	2		Watson
Nut, M14	W520215-S440	4	103	Ford Dealer
Bolt, M14x90	BFD14X90YLW	2		Belmetric
Bolt, M14x77	W711504-S439	2	175	Ford Dealer
Spacer, Subframe Side	TOE-LINK-HEIM-SPACER	4		Watson
Anti Roll Bar, Rear	FR3Z-5A772-E	1		Ford Dealer
Bushing for Anti Roll Bar, Rear	F2GZ-5493-C	2		Ford Dealer
Clamp (Anti-Roll Bar to Subframe)	DG9Z-5B484-A	2		Ford Dealer
Bolt, M10x25 (Clamp to Subframe)	W711918-S439	4	70	Ford Dealer
Adjustable Rear Drop Link, Anti Roll Bar	LCR-DH-RSBL	2		Capaldi Racing
Bracket (Brake Line to Anti Roll Bar) RH	PR3Z-2082-B	1		Ford Dealer
Bracket (Brake Line to Anti Roll Bar) LH	PR3Z-2082-A	1		Ford Dealer
Nut, M12x1.75 (Link To Anti Roll Bar / Lower Control Arm)	W520214-S440	4	65	Ford Dealer
Rear ARB Hardware Kit	DHR-RSWYBRHRDWR	1		Watson
Hex Bolt, M12-1.75x60, Modified	42-212160	2	65	Kimball Midwest
Hex Bolt, M12-1.75x50, Modified	42-212150	2	65	Kimball Midwest
PIA, Sleeve, 5/8 Dia x 1/2 Stock	N/A	2		N/A
PIA, Sleeve 5/8 Dia x 3/8 STK	N/A	2		N/A
Spring, Rear	HYP186C1000	2		HRP
Spring Bearing Kit, Rear (2")	GEN-GC1017	2		HRP
Brake System	-	-	-	-
Anti-Lock Brake System (ABS)	-	-	-	-
Dark Horse R ABS M5 Clubsport Kit	FP-2353-DHR	1		Technosports
PIA, ABS Module (500kbaud/DF11S)	F02U.V05.287-01	1		Technosports
PIA, Pressure Sensor	0261.008.022	2		Technosports
PIA, Yaw / Acceleration Sensor	F02U.V02.589-01	1		Technosports
Bolt, M10-1.0 (Sensor to Bracket)	241958	2	50	Kimball Midwest
PIA, Mounting Plate, Yaw Sensor	1271.032.390	1		Technosports
Bolt, M6x16 (Bracket to Frame)	45-20616	2	10	Kimball Midwest
PIA, 12 Position Switch	F02U.V03.390-01	1		Technosports
PIA, ABS M5 Scale, Standard	F02U.004.709-01	1		Technosports
MSA Box, Signal Converter	F02U-V00-327-03	1		Technosports
ABS Bracket	DHR-ABSBRKT-AS	1		Watson
Nylock Nut, M6-1.0	46-5506	4	10	Kimball Midwest
Isolator (Male/Male Bobbin)	2008MM10-60	4		AV Industrial

Bill of Materials (Cont.)

Part Description	Part Number	Qty	Torque Nm	Supplier
Front Brakes	-	-	-	-
Brake Kit, Front	7K2-9005AK	1		Race Technologies
Caliper RH	XB8GK52	1		Race Technologies
Caliper LH	XB8GK51	1		Race Technologies
PIA, Copper Washer	06.2196.13	4		Race Technologies
PIA, Bolt, M10x1.0, -3AN Male	06.3710.20	2	24	Race Technologies
Bracket, Caliper	20B71805	2		Race Technologies
Studs, Bracket to Caliper	80080C	4		Race Technologies
Washer, Bracket to Caliper	WS-7	4		Race Technologies
Nuts, Bracket to Caliper	MS-7	4	92	Race Technologies
Disc RH	759B97946	1		Race Technologies
Disc LH	759B97936	1		Race Technologies
Bell	16B71452	2		Race Technologies
Bolts, Bell	05582916	42	7	Race Technologies
Ring, Bell	05A46739	2		Race Technologies
Front Brake Pad Kit	BRP34-1980WA.29B	1		Race Technologies
Bolt, M12x38 (Caliper Bracket to Knuckle)	W721714-S439	4	110	Ford Dealer
ABS Wire Front RH (S550)	JR3Z-2C205-A	1		Ford Dealer
ABS Wire Front LH (S550)	JR3Z-2C204-A	1		Ford Dealer
Bolt, M6x12	W500011-S442	2	9	Ford Dealer
ABS Wire Bracket RH, Front, Modified	PR3Z-2C224-B	1		Ford Dealer
ABS Wire Bracket LH, Front, Modified	PR3Z-2C224-A	1		Ford Dealer
Rivet, 6.6x23.9	W707874-S417	2		Ford Dealer
Bolt (ABS Wire Bracket to Damper)	W505424-S442	2	110	Ford Dealer
Brake Line Bracket Kit	DHR-FRTBRKLINE-BRKT	1		Watson
PIA, Front Brake Line Bracket LH	DHR-LH-FRT-BRKLN-BRKT	1		Watson
PIA, Front Brake Line Bracket RH	DHR-RH-FRT-BRKLN-BRKT	1		Watson
Bolt, M6	45-20616	2	10	Kimball Midwest
Rivnut, M6	46-5506	2		Kimball Midwest
P-Clamp, 1/4"	26-461	2		Kimball Midwest
Brake Line Bracket RH, Modified	WMOD-2078-D	1		Watson
PIA, Hose Assembly Front RH (Donor Part for Bracket)	PR3Z-2078-D	1		Ford Dealer
Brake Line Bracket LH, Modified	WMOD-2078-C	1		Watson
PIA, Hose Assembly Front LH (Donor Part for Bracket)	PR3Z-2078-C	1		Ford Dealer
Screw, M8x20 (Front Hose)	W505263-S439	2	27.5	Ford Dealer
Screw, M8x20 (Rear Hose)	W505263-S439	4	35	Ford Dealer
Booster	FR3Z-2005-G	1		Ford Dealer
Master Cylinder	FR3Z-2140-C	1		Ford Dealer
Nut, M8 (Master to Booster)	W520212-S440	2	22.5	Ford Dealer
Cap, Master Cylinder	BV6Z-2162-A	1		Ford Dealer
Bushing, Booster to Pedal Box	3M5Z-2L523-AA	1		Ford Dealer
Vacuum Hose, Modified	FR3Z-2420-K	1		Ford Dealer
Hose, 5/8" (2in long)	NBH H183	1		NAPA
Fitting, 90deg Elbow	NBH-9924	1		NAPA
Nut / Washer, M6	W710771-S442	2	10	Ford Dealer
Oetiker Clamp, 25.6mm	16700031	3		Grainger
Front Brake Backing Plate Kit	WR-BRK-BCK-DHR	1		Watson
Front Brake Backing Plate RH	DHR-BRAKE-BKNG-PLT-R	1		Watson
Front Brake Backing Plate LH	DHR-BRAKE-BKNG-PLT-L	1		Watson
Bolt, M8x16	45-20816	6	22	Kimball Midwest

Bill of Materials (Cont.)

Part Description	Part Number	Qty	Torque Nm	Supplier
Rear Brakes	-	-	-	-
ABS Wire (Rear)	PR3Z-2C190-A	2		Ford Dealer
Bolt, M6x16	W505253-S450L	2	10	Ford Dealer
Caliper Rear RH	PR3Z-2552-B	1		Ford Dealer
Caliper Rear LH	PR3Z-2553-B	1		Ford Dealer
Bolt, M12x100	W722051-S439	4	133	Ford Dealer
Rear Brake Disc	PR3Z-2C026-A	2		Ford Dealer
Rear Brake Pad Kit	P1309-17	1		Race Technologies
Caliper Banjo Bolt, M10x1	BJB-03-2-7-S-W	2	24.5	BMRS
Copper Washer for Brake Lines, 10.2x15x1.2	W711784-S300	4		Ford Dealer
Rear Brake Line RH, Modified (Donor Part for Brackets)	PR3Z-2282-B	1		Ford Dealer
Rear Brake Line LH, Modified (Donor Part for Brackets)	PR3Z-2282-D	1		Ford Dealer
Rear Brake Line Spacer Kit	N/A	2		Watson
Rear Brake Line Spacer 1, 0.290 line	DHR-BRAKELINESPCR1	4		Watson
PIA, Spacer 1	N/A	2		Watson
P-Clamp, 1/2"	26-474	1		Kimball Midwest
Rear Brake Line Spacer 2, 0.187 line	DHR-BRAKELINESPCR2	2		Watson
PIA, Spacer 2	N/A	2		Watson
P-Clamp, 1/2"	26-474	1		Kimball Midwest
Brake Lines	-	-	-	-
Stainless Steel Brake Line Kit	DHR-SSBRAKELINEKIT	1		Watson
PIA, Master Cylinder to ABS (Front)	DHR-BRKLIN1	1		Watson
Master Cylinder Fitting, Male Tube Nut, M14 x 1.5, Double Flare, 1/4" Line	9183-MTN	1		Watson
Bosch PST-F1 Sensor-NPT 1/8" Male Adapter	LCR-DH-BOSCH-ADP	1		Capaldi Racing
Female Branch Tee-S316, 1/4x1/8"	N/A	1		Michigan Valve & Fitting Inc
PIA, Master Cylinder to ABS (Rear)	DHR-BRKLIN2	1		Watson
Master Cylinder Fitting, Male Tube Nut, M14 x 1.5, Double Flare, 1/4" Line	9183-MTN	1		Watson
Bosch PST-F1 Sensor-NPT 1/8" Male Adapter	LCR-DH-BOSCH-ADP	1		Capaldi Racing
Female Branch Tee-S316, 1/4x1/8"	N/A	1		Michigan Valve & Fitting Inc
PIA, ABS to Rear LH	DHR-BRKLIN3	1		Watson
PIA, ABS to Rear RH	DHR-BRKLIN4	1		Watson
PIA, ABS to Front LH	DHR-BRKLIN5	1		Watson
PIA, ABS to Front RH	DHR-BRKLIN6	1		Watson
P-Clamp, 1/4"	26-461	2		Kimball Midwest
Bolt, M6x16	45-20616	2	10	Kimball Midwest
Flexible Brake Line Kit	DHR-FLEX-BRK-LINES	1		Watson
PIA, Rear Brake Line LH	FORDM-B01	1		BMRS
PIA, Rear Brake Line RH	FORDM-B02	1		BMRS
PIA, Front Brake Line RH	FORDM-B04	1		BMRS
PIA, Front Brake Line LH	FORDM-B05	1		BMRS
P-Clamp, 1/4"	26-461	2		Kimball Midwest
Bolt, M6x14	W500212-S450	2	10	Ford Dealer
Nut, M6	W520201-S450B	2	10	Ford Dealer
Rear Brake Line Bundle	PR3Z-9J279-A	1		Ford Dealer
Driveline System	-	-	-	-
Sealed Differential	FP-4001-DHRA	1		Watson
Bolt / Washer, M14x75 (Diff to Subframe)	W716983-S439	2	175	Ford Dealer

Bill of Materials (Cont.)

Part Description	Part Number	Qty	Torque Nm	Supplier
Bolt, M14x90 (Diff to Subframe)	W716979-S439	2	175	Ford Dealer
Barbed Fitting (for Diff Vent)	2L1Z-4022-BA	1		Ford Dealer
Rear Catch Can - Differential	JOES-12310	1		HRP
Rear Catch Can Kit - Differential	DHR-RCTCHCAN-DIFF	1		N/A
Rivnut , M4-7	85411	2		Kimball Midwest
Bolt, M4x0.7x20mm	91280A045	2		McMaster Carr
Flat Washers	45-3504	2		Kimball Midwest
Rear Diff Hose, 5/16" Hose, 30" long	H176	1		NAPA
Barbed Hose Fitting, Straight Adapter for 5/16" Hose ID	5346K16	1		McMaster Carr
Rubber Grommets	26-822	1		Kimball Midwest
Front Catch Can - Transmission	JOES-12310	1		HRP
Front Catch Can Kit- Transmission	DHR-FCTCHCAN-TRANS	1		N/A
Rivnut , M4-7	85411	2		Kimball Midwest
Bolt, M4x0.7x20mm	91280A045	2		McMaster Carr
Flat Washers	45-3504	2		Kimball Midwest
Front Hose, 39 1/2" long	H176	1		NAPA
Barbed Hose Fitting, 90° Elbow for 5/16" Hose ID	53525K14	1		McMaster Carr
Rubber Grommets	26-818	2		Kimball Midwest
Differential Temperature Sensor	9L8Z-6G004-E	1		Ford Dealer
Half Shaft RH, Modified	DHR-HALFSHAFT-MODR	1		Watson
PIA, Axle Shaft RH	KR3Z-4K138-D	1		Ford Dealer
Nut, M22 (Shaft to Hub)	CCPZ-3B477-G	1	115	Ford Dealer
CV Boot RH	M-3A331-GT4B	2		Ford Performance Parts
Clamp, 3/8 X 16"	AS6239	2		Band-It
CV-2 Grease with Moly	RED-80401	0.5		HRP
Half Shaft LH, Modified	DHR-HALFSHAFT-MODL	1		Watson
PIA, Axle Shaft LH	KR3Z-4K139-G	1		Ford Dealer
Nut, M22 (Shaft to Hub)	CCPZ-3B477-G	1	115	Ford Dealer
CV Boot LH	M-3A331-GT4A	2		Ford Performance Parts
Clamp, 3/8 X 16"	AS6239	2		Band-It
CV-2 Grease with Moly	RED-80401	0.5		HRP
Transmission Cooler w/ Top Bracket	PR3Z-6A642-A	1		Ford Dealer
Bracket (Lower Mounting of Cooler)	FR3Z-6K743-A	1		Ford Dealer
Bolt, M6x25	W721571-S442	2	10	Ford Dealer
Bolt, M8x22 (Top Upper Bracket)	W503293-S439	1	22	Ford Dealer
Bolt / Washer, M8x27	W709390-S439	1	22	Ford Dealer
U-Nut Clip, M8 (Bracket to K Member)	W709990-S439	1	22	Ford Dealer
Sealed Transmission	FP-7003-DHR	1		Technosports
Service Transmission	N/A	1		Hanlon Motorsports
Stud, M10x60+M6x16	W719349-S439	3	47.5	Ford Dealer
Bolt, M10x60	W714289-S437	2	47.5	Ford Dealer
Stud, M10x75+M6x12	W718165-S439	1	47.5	Ford Dealer
Stud, M10x80+M6x12	W714416-S437	1	47.5	Ford Dealer
Plate (Between Engine Block and Bell Housing)	JL3Z-7007-C	1		Ford Dealer
Shifter, Modified	DHR-SHIFTER-MOD	1		Watson
PIA, Shifter	MR3Z-7210-A	1		Ford Dealer
Bolt / Washer, M10x65 (To Trans)	W715200-S437	1	40	Ford Dealer
Bolt, M8-1.25x25 (to Interlink)	4R3Z-7C211-AA	1	15	Ford Dealer
Nut, M6 (Shifter to Body)	W520101-S450	2	10.5	Ford Dealer
PIA, Boot	N/A	1		Ford Dealer

Bill of Materials (Cont.)

Part Description	Part Number	Qty	Torque Nm	Supplier
Shifter Kit	LCR-7210-A	1		Capaldi Racing
PIA, Handle	LCR-DH-SHIFTER	1		Capaldi Racing
PIA, Reverse Lock Out	LCR-DH-RLO	1		Capaldi Racing
PIA, Shift Knob	LCR-DH-SHIFT-KNOB	1		Capaldi Racing
Clutch, Disc	FP-7550-DHR	1		Centerforce
Clutch, Pressure Plate	FP-7563-DHR	1		Centerforce
Clutch, Flywheel (includes Pressue Plate Hardware)	FP-6375-DHR	1		Centerforce
Clutch, Throwout Bearing	FP-7508-DHR	1		Centerforce
Clutch Line, Stainless Steel	S650-DHR-CLUTCH-LINE	1		Watson
Clutch Master Feed Kit	LCR-CMFK-DH	1		Capaldi Racing
Tube, 90deg (Trans to Clutch Line)	7R3Z-7K505-A	1		Ford Dealer
Transmission Mount Assembly	N/A	1		Technosports
Isolator	BR3Z-7E373-B	1		Ford Dealer
Cross Member	BR3Z-6A023-B	1		Ford Dealer
Bolt / Washer, M12x54	W720138-S439	4	62.5	Ford Dealer
Bolt, M12x75	W715936-S437	3	103	Ford Dealer
Transmission Cooler Lines Kit	DHR-TRANS-CLR-LINES	1		Watson
Line (From Trans), Modified	DHR-TRANSLINE-TRANS	1		Watson
Line (From Trans)	PR3Z-7R081-F	1		Ford Dealer
PIA, Transmission In	DHR-TRNS-CLR-LIN-1A	1		Watson
PIA, Transmission Out	DHR-TRNS-CLR-LIN-2A	1		Watson
Line (from Production Engine Oil Cooler used for DHR Trans Cooler), Modified	DHR-TRANSLINE-COOL	1		Watson
Line (from Production Engine Oil Cooler used for DHR Trans Cooler)	PR3Z-6B850-A	1		Ford Dealer
Plastic Push Rivet, 6.5x4.5-7	W714040-S300	1		Ford Dealer
P-Clamp, 1/2"	26-464	4		Kimball Midwest
Bolt, M6x16	W505253-S450L	4	10	Ford Dealer
Bolt, M6x15	W721914-S450	2	10	Ford Dealer
Nut / Washer, M10	W520125-S442	2	47.5	Ford Dealer
Zip Tie (AN Lines to K Member)	26-684	6		Kimball Midwest
Bolt, M6 (AN Lines to K Member)	45-20616	2	10	Kimball Midwest
P-Clamp, 3/4" (AN Lines to K Member)	26-466	4		Kimball Midwest
Drive Shaft	PR3Z-4R602-G	1		Ford Dealer
PIA, Bolt (Shaft to Diff)	N/A	6	62.5	Ford Dealer
Bolt, M12-1.75x27 (Shaft to Trans)	N800594-S101	4	110	Ford Dealer
Bolt, M10x19 (Center Bearing to Body)	W717822-S439	2	47.5	Ford Dealer
Front Drive Shaft Loop Kit	CM-5478-MGTF	1		Watson
PIA, Loop, U Bracket	N/A	1		Watson
PIA, Bottom Plate	N/A	1		Watson
PIA, Weld Stud Plate	N/A	2		Watson
Bolts, M8-1.25x35	4520825	4	22	Watson
Nylon Nuts, M8-1.25	465508	8	22	Watson
Square Washers 5/16"	99041A105	2		McMaster Carr
Rear Drive Shaft Loop Kit	CM-5478-350S-R	1		Watson
PIA, Loop	N/A	1		Watson
PIA, Cross Bar	N/A	1		Watson
Weld Stud Plate	N/A	2		N/A
Bolts, M8-1.25x35	4520825	4	22	Kimball Midwest
Nylock Nut, M8-1.25	465508	8	22	Kimball Midwest
Wiring Modified to Differential Pump	WMOD-GEN-GC1111	1		Watson
Differential Pump (Genesis)	GEN-GC1111	1		HRP
X-Tree Zip Tie	T-50RTM	2		Kimball Midwest
Fitting, Male -8 AN to 3/8" Male Pipe (Diff Pump)	FBM5007	2		HRP
Bolt, M8 (Pump to Bracket)	4653286	4	22	Kimball Midwest
Bolt, M8 (Pump Bracket to Rear Subframe)	4653286	2	22	Kimball Midwest

Bill of Materials (Cont.)

Part Description	Part Number	Qty	Torque Nm	Supplier
Bracket (Diff Pump to Body)	DHR-DIFFPMPBRKT-AS	1		Watson
Wiring Modified to Differential Cooler and Fan Unit	WMOD-SETFP920M22I	2		Watson
Differential Cooler and Fan Unit	SETFP920M22I	2		HRP
Zip Tie	26-681	2		Kimball Midwest
Bracket , Differential Cooler and Fan Unit	DHR-DIFF-CLR-BRKT	2		Watson
Fitting, Setrab M22-AN08 Adapter (Differential Coolers)	SET22-M22AN08-SE	4		HRP
Differential Cooler Line Kit	DHR-DIFF-CLR-LINES	1		Watson
LH Cooler Out / Differential In	S650-DHR-DIFF-LINE-HOSE1	1		Watson
Pump Out / RH Cooler In	S650-DHR-DIFF-LINE-HOSE2	1		Watson
Differential to Pump In	S650-DHR-DIFF-LINE-HOSE3A	1		Watson
RH Cooler Out / LH Cooler In	S650-DHR-DIFF-LINE-HOSE4	1		Watson
Filter Screen for Differential Cooler	SET11-UF08	1		HRP
Isolator for Differential Cooler	2008MM10-60	8		AV Industrial
Steering System	-	-	-	-
Steering Column	PR3Z-3C529-A	1		Ford Dealer
Nut, M8x1.25	W520102-S437	4	25	Ford Dealer
Steering Shaft w/ Bearing	PR3Z-3E751-A	1		Ford Dealer
Bolt, M8x31 (Shaft to Column)	W714878-S450	2	30	Ford Dealer
Nut / Washer, M6 (Bearing to Firewall)	W707137-S437	2	9	Ford Dealer
Multifunction Switch, Modified	DHR-CLMNSWTCH-MOD	1		Watson
Multifunction Switch	PR3Z-3F791-FA	1		Ford Dealer
Screw, M5x25	W504698-S451	4	2.8	Ford Dealer
Steering Shaft (Lower)	FR3Z-3B676-B	1		Ford Dealer
Yoke (Lower Shaft to Rack)	FR3Z-3N725-B	1		Ford Dealer
Bolt, M8x31 (Shaft to Yoke, Yoke to Rack)	W714878-S450	2	30	Ford Dealer
Programmed EPAS	FP-3D070-DHR	1		Ford Performance / Technosports
Bolt / Washer, M16x79 (EPAS)	W717106-S439	2	200	Ford Dealer
Tie Rod Kit	PR3Z-3280-A	1		Ford Dealer
Tie Rod End	PR3Z-3A130-A	1		Ford Dealer
Steering Hub	01502067CA	1		Sparco SPA
Bolt / Washer, M10x37 (Hub to Column)	W721079-S437	1	62.5	Ford Dealer
Quick Release w/ Hardware (Steering Wheel to Hub)	015R98TU	1		Sparco SPA
Bolt, M5-0.80x20	4653455	6	2.8	Kimball Midwest
Nut, M5	46-5505	6	2.8	Kimball Midwest
Steering Wheel	M-3600-RA	1		Ford Performance Parts
Steering Wheel Hook	JOES-10704-B	1		HRP
Steering Wheel Switch Plate	DHR-STRNGWHLSWTCH	1		Watson
Pedals	-	-	-	-
Pedal Box Assembly (Brake & Clutch) S550	FR3Z-2455-AH	1		Ford Dealer
Bolt / Washer, M8x31 (Pedal Box Assembly to Body)	W707108-S439	4	22.5	Ford Dealer
Nut, M8 (Booster to Pedal Box Assembly)	W520212-S440	6	22.5	Ford Dealer
Brake Pedal Switch	GL3Z-13480-A	1		Ford Dealer
Gas Pedal	CR3Z-9F836-H	1		Ford Dealer
Nut, M6 (Pedal to Body)	W711330-S442	3	9	Ford Dealer
Switch (Lower Clutch)	PR3Z-11A152-A	1		Ford Dealer
Clutch Master Cylinder Assembly S650	PR3Z-7A543-A	1		Ford Dealer

Bill of Materials (Cont.)

Part Description	Part Number	Qty	Torque Nm	Supplier
Information, Programing, Gauge & Warning System	-	-	-	-
Motec System, MC187	MC187-USB-DARKHORSE	1		Motec USA
Motec System, GPS	CFP-MGPS-L10	1		Motec USA
Grommet, 5/8" ID (Installed on Roof)	26-822	1		Kimball Midwest
Zip Tie	26-684	7		Kimball Midwest
X-Tree Zip Tie	T-50RTM	2		Kimball Midwest
Bracket (Mount Screen to Clock Spring)	DHR-MOTECBRKT	1		Watson
Weld Nut, M4	93337A500	2	2.2	McMaster Carr
Washer, M5	45-3505	3		Kimball Midwest
Nylock Nut, M5x0.8	46-5505	3	2.8	Kimball Midwest
Screw, M4-1.0x10	46-3266	2	2.2	Kimball Midwest
Procal 4	M-12655-F	1		Ford Performance Parts
Ambient Temperature Sensor	DA8Z-12A647-C	1		Ford Dealer
Engine Oil Temperature Sensor	CFP-M25-2197D	1		Motec USA
Transmission Temperature Sensor	CFP-M25-2197D	1		Motec USA
X-Tree Zip Tie	T-50RTM	1		Kimball Midwest
Transponder Bracket	DHR-LAPSBKRT	1		Watson
Bolt, M6x16 (Bracket to Body)	4520616	2	10	Kimball Midwest
Bolt, M4x10 (Transponder to Bracket)	2759802	2	2.2	Kimball Midwest
Rivnut, M4	85411	2		Kimball Midwest
Electrical	-	-	-	-
Battery	BAGM-48H6-760	1		Ford Dealer
Battery Vent Tube	R1MZ-10A818-B	1		Ford Dealer
Battery Harness, Modified	PR3T-14B060-PGMOD	1		Technosports
PIA, Battery to Breaker Cable	FP-14B060-AA	1		Technosports
PIA, Breaker to Kissling Relay Cable	FP-14B060-BA	1		Technosports
P-Clamp, 3/4"	26466	1		Kimball Midwest
Nut / Washer, M6 (to PDB)	W716298-S450	6	10.5	Ford Dealer
Screw, M6x20	W505424-S442	2	12	Ford Dealer
Nut, M6 Nylon Insert (to Body)	W520201-S440	1	12	Ford Dealer
Fuse Panel (PDB)	PR3Z-14A068-B	1		Ford Dealer
Fuse Panel Cover	PR3Z-14A003-A	1		Ford Dealer
Fuse Panel Mounting Bracket	PR3Z-14A254-C	1		Ford Dealer
Bolt / Washer, M6x25	W711158-S442	1	10	Ford Dealer
Underhood PDB Harness, Modified	PR3T-14290-FHLAMOD	1		PRS
Bolt, M6	45-20616	2	10	Kimball Midwest
Zip Tie	26-684	2		Kimball Midwest
Bolt / Retainer, M6x20	W710381-S439	1	10	Ford Dealer
Ground Bolt, M6x20	W505255-S450L	9	12	Ford Dealer
Zip Tie	26-684	10		Kimball Midwest
P-Clamp, 3/8"	26-463	1		Kimball Midwest
Ground Bolt, M6x20	W505255-S450L	1	12	Ford Dealer
Front Overlay Loom	FP-14290-AB	1		PRS
Cap Connector	FR3Z-14A666-A	1		Ford Dealer
Main Breaker	353250	1		Technosports
Socket Head Cap Screw, M6-1.0x20	46-50620	2	10	Kimball Midwest
Screw / Washer (Self-Tapping), M6x18	W705968-S439	1	10	Ford Dealer
Main Relay	29-311-11	1		Technosports
Socket Head Cap Screw, M6-1.0x20 (Relay)	46-50620	2	10	Kimball Midwest
Zip Tie	26-684	1		Kimball Midwest
Main Body Harness, Modified (Overlay)	PR3T-14A005-CGLBMOD	1		Technosports
Screw / Washer, M6x20	W716914-S439	4	9	Ford Dealer
Zip Tie	26-684	25		Kimball Midwest
Ground Bolt, M6x16 (Trunk)	W505253-S450L	2	12	Ford Dealer

Bill of Materials (Cont.)

Part Description	Part Number	Qty	Torque Nm	Supplier
Ground Bolt, M6x16 (B-Pillar)	W505253-S450L	2	12	Ford Dealer
Ground Bolt, M6x16 (Lower Foot Well)	W505253-S450L	2	12	Ford Dealer
Rivet	PR43-SSP	4		Reid
X-Tree Zip Tie	T-50-RTM	2		Terminal Supply Co.
Grommet, 5/8" ID	26-822	4		Kimball Midwest
Cockpit Loom	FP-14A005-AB	1		PRS
Zip Tie	26-684	3		Kimball Midwest
Ground Bolt, M6x16	W505253-S450L	1	12	Ford Dealer
P-Clamp, 3/8"	26-463	1		Kimball Midwest
Radio Jumper (compatible with Cars 001-040)	FP-14401-AA	1		Technosports
HS2-CAN Jumper (compatible with Cars 001-040)	FP-14401-CA	1		Technosports
CAN Bridge Loom (IP) (compatible with Cars 001-040)	FP-14401-DA	1		Technosports
Instrument Panel (Dash) Harness, Modified	PR3T-14401-EFMOD	1		Technosports
Ground Bolt, M6x20	W505255-S450L	4	12	Ford Dealer
Zip Tie	26-684	25		Kimball Midwest
X-Tree Zip Tie	T-50-RTM	2		Terminal Supply Co.
Zip Tie	26-684	5		Kimball Midwest
Alternator Assembly	PR3Z-10346-B	1		Ford Dealer
Stud, M10x19.8+M10x33.3	W712609-S437	1	8	Ford Dealer
Nut, M10	W520414-S442	1	47.5	Ford Dealer
Bolt / Washer, M10x92	W715092-S437	1	47.5	Ford Dealer
Nut / Washer, M8	W711953-S900	1	17.5	Ford Dealer
PCM	FP-12A650-DHR	1		Ford Dealer
Bolt, M6x25 (PCM to Bracket)	W500015-S442	2	10	Ford Dealer
Engine Pocket Connector (PCM)	FP-14S4111-EA	1		Technosports
Transmission Pocket Connector (PCM)	FP-14S4111-TA	1		Technosports
Vehicle Pocket Connector (PCM)	FP-14S4111-VA	1		Technosports
Bracket (PCM to Body)	PR3Z-12A659-C	1		Ford Dealer
Bolt, M6x20 (PCM to Body)	W716914-S307	2	10	Ford Dealer
Nut Clip, M6	W710198-S439	1		Ford Dealer
Bracket (PCM Support)	DHR-PCMBRKT-AS	1		Watson
Bolt, M6-1.0x16	45-20616	3	10	Kimball Midwest
P-Clamp, 1-1/2"	26-480	1		Kimball Midwest
Rivnut, M6-1.0	85-413	2		Kimball Midwest
Wiring - Clutch Pedal Position	PR3Z-15K857-AA	1		Ford Dealer
Body Ancillary Module + Bracket	RR3Z-13C788-B	1		Ford Dealer
Body Control Module (BCM)	PR3Z-15604-B	1		Ford Dealer
Nut / Washer, M6	W702751-S442	1	8	Ford Dealer
Hegos (O2 Sensor), Black RH	PR3Z-9F472-A	1		Ford Dealer
Hegos (O2 Sensor), Gray LH	PR3Z-9F472-E	1		Ford Dealer
RH Door Harness, Modified	PR3T-14630-HGMOD	1		Technosports
LH Door Harness, Modified	PR3T-14631-KGMOD	1		Technosports
Zip Tie	26-684	2		Kimball Midwest
Differential Pump Jumper Harness	FP-14A411-AA	1		Technosports
Zip Tie	26-684	8		Kimball Midwest
Plug, 36x0.8-1.5	W711539-S300	1		Ford Dealer
Fuel Pump Jumper Harness	FP-2B572-AA	1		Technosports
Zip Tie	26-684	14		Kimball Midwest
P-Clamp, 3/4"	26-466	2		Kimball Midwest
P-Clamp, 3/8"	26-463	2		Kimball Midwest
Ground Bolt, M6x16	W505253-S450L	1	12	Ford Dealer
Nut, M6	W711330-S442	1	12	Ford Dealer
Differential Temp / Rear Chassis Harness, Modified	PR3T-2B572-FFMOD	1		Technosports
Zip Tie	26-464	2		Kimball Midwest



Bill of Materials (Cont.)

Part Description	Part Number	Qty	Torque Nm	Supplier
Gateway Module	PU5Z-14G490-AE	1		Ford Dealer
Screw, M6x20	W505424-S442	4	6.2	Ford Dealer
Ground Wire	PR3Z-19A095-B	1		Ford Dealer
PIA, Nut	W715955-S900	1	10.5	Ford Dealer
PIA, Nut	W718941-S900	1	10.5	Ford Dealer
Bolt, M6x14	W500212-S450	1	13.5	Ford Dealer
CAN Bridge Module	CAN-FD-Bridge	1		Technosports
CAN Bridge Flash	FP-CANBRIDGEv1.0-DHR	1		N/A
3M Dual Lock Velcro, 3in	SJ3550CFBK1"X50YD-ND	4		3M
Interior Master Power Panel	DHR-MSTR-PWR-PNL	1		Watson
Rivet, 1/8"	PR4Z-SSP	2		Kimball Midwest
Exterior Power Panel (Kill Switch / Fire Switch) Red	DHR-EXTRPWRPNL	1		Watson
Rivet	MARSABL6-6	2		Metro Bolt & Fastener
Grommet, 5/8" ID	26-822	2		Kimball Midwest
Center Stack Switch Panel	DHR-CENTERSTACK	1		Watson
Screw, M6-1.0x20	92095A240	4	10	McMaster Carr
Rivnut, M6-1.0	85413	2		Kimball Midwest
Zip Tie	26-684	12		Kimball Midwest
Lower Switch Panel Harness	FP-14401-BA	1		PRS
OBD2 Mounting Plate	DHR-OBD2-MNT-PLT	1		Watson
Rivnut, M6-1.0	85413	3		Kimball Midwest
Button Head Screw, M6-1.0x30	2729796	3	10	Kimball Midwest
Button Head Screw, M3-0.50x15	91290A572	3	1	McMaster Carr
Nut, M3x0.50	46-3503	3	1	Kimball Midwest
Headlight Assembly RH, Modified	FP-13005-DHR	1		Technosports
Bolt / Washer, M6x18	W720434-S450B	1	8	Ford Dealer
Bolt / Washer, M6x32	W722695-S439	2	3.2	Ford Dealer
Headlight Assembly LH, Modified	FP-13006-DHR	1		Technosports
Bolt / Washer, M6x18	W720434-S450B	1	8	Ford Dealer
Bolt / Washer, M6x32	W722695-S439	2	3.2	Ford Dealer
Tail Light Assembly LH	PR3Z-13404-D	1		Ford Dealer
Nut / Washer, M6	W710771-S442	3	6.2	Ford Dealer
Tail Light Assembly LH	PR3Z-13405-D	1		Ford Dealer
Nut / Washer, M6	W710771-S442	3	6.2	Ford Dealer
Trim (Top of Tail Light) RH	PR3Z-13420-A	1		Ford Dealer
Trim (Top of Tail Light) LH	PR3Z-13420-B	1		Ford Dealer
3rd Brake Light Assembly (Rain Light)	DS7Z-13A613-C	1		Ford Dealer
Nut, M5	W520200-S437	4	4.1	Ford Dealer
Zip Tie	26-684	5		Kimball Midwest
Headlamp Position Control Module	NL1Z-13K198-N	1		Ford Dealer
Headlamp Switch / Bezel	PR3Z-11654-AA	1		Ford Dealer
Rear Lamp Assembly RH	PR3Z-15A201-A	1		Ford Dealer
Rear Lamp Assembly LH	PR3Z-15A201-C	1		Ford Dealer
Fuel Pump Driver	PR3Z-9D370-A	1		Ford Dealer
Nut, M6	W705460-S437	1	10	Ford Dealer
Bolt / Washer, M6x35	W711973-S439	1	10	Ford Dealer
Steering Wheel Switch Plate Harness	FP-14A664-AA	1		PRS
Fluids	-	-	-	-
Gear Lube (Motorcraft 75W-85), 1 quart	XY-75W85-QL	4		Ford Dealer
Coolant (Motorcraft Gold) (50/50), 1 gallon	VC-13-G	1.5		Ford Dealer
Transmission Fluid (Motorcraft Mercon LV), 1 quart	XT-10-QLVC	4		Ford Dealer
Oil (Motorcraft 5W-50), 1 quart	XO-5W50-QGT	15		Ford Dealer
Paint	PMPC-19500-5920A	1		Ford Dealer
Brake Fluid, Brembo HTC64	04816420	5		Race Technologies

Bill of Materials (Cont.)

Part Description	Part Number	Qty	Torque Nm	Supplier
Green Loctite	LOC1835205	0.2		HRP
Loctite Primer	LOC494147	0.1		HRP
Blue Loctite	TA-25B	1		Ford Dealer
Red Loctite	TA-26	1		Ford Dealer
Plastic Welder II	IT412	0.25		R.S. Hughes
Safety Systems	-	-	-	-
Safety Harness	SAB-CFCI22100056	1		HRP
PIA, Eye Bolt, 7/16	N/A	3	40	HRP
Fender Washer, 7/16-2.51 OD	2.500-0.468-.3075S-Z	1		Global Fastener
Nut, 7/16 - 20	348507	3	40	Kimball Midwest
Two-Piece Lock Collar, ID 1.75"	GEN-GA3277	2		HRP
Seat	071.38.0630-01	1		Recaro
PIA, Bolt (M20x20, Grade 10.9)	N/A	4	22	Recaro
Button Head Bolt, M8-1.25x25	2628989	4	35	Kimball Midwest
Bracket, Seat	7206293NA	1		Recaro
Button Head Bolt, M8-1.25x25 (Seat Bracket)	2628989	4	35	Kimball Midwest
Washer, M8 (Seat Bracket)	45-3508	4		Kimball Midwest
Fire Suppression System	014772MSL	1		Sparco SPA
PIA, Fire Bottle	N/A	1		Sparco SPA
PIA, Line Kit	N/A	1		Sparco SPA
PIA, Fire Bottle Mount	N/A	1		Sparco SPA
Bolt, M6x16	W505253-S450L	13	10	Ford Dealer
Flange Nut, M6	46-15006	1		Kimball Midwest
Grommet, 3/8" ID	26-814	1		Kimball Midwest
P-Clamp, 1/2"	26464	5		Kimball Midwest
P-Clamp, 3/8"	26463	5		Kimball Midwest
Window Net Rod Kit	DHR-NETHRDWR	1		Watson
Nylock Nut, 3/8-24	90101A245	1	40	McMaster Carr
Screw, 3/8x1.0x24	91306A297	1	40	McMaster Carr
Driver Window Net	LCR-DH-LHWN	1		Capaldi Racing
Helmet Support Net, Right Side (Ratchet Release)	SFC-8011-KFIA	1		HRP
PIA, Net Assembly	N/A	1		HRP
PIA, Clip	N/A	3		HRP
Two-Piece Lock Collar, ID 1.75"	GEN-GA3277	2		HRP
Windshield Washer Tubing, 3.5"	H459	1		NAPA
Zip Tie	26-680	3		Kimball Midwest
Helmet Support Net, Left Side (Quick Release)	SFC-8111-K-L-FIA	1		HRP
PIA, Net Assembly	N/A	1		HRP
PIA, Clip	N/A	3		HRP
PIA, Jam Nut	N/A	1		HRP
Roll Bar Padding Kit	DHR-ROLLBARPAD-MOD	1		Watson
Roll Bar Padding	BSCI-78001	1		HRP
PIA, A Pillar, 25in	N/A	1		HRP
PIA, A Pillar Support Upper, 9.5in	N/A	1		HRP
PIA, A Pillar Support Lower, 20.5in	N/A	1		HRP
PIA, Header, 10in	N/A	1		HRP
PIA, Roof Bar Forward, 22in	N/A	1		HRP
PIA, Door Bar Upper, 4in	N/A	1		HRP
PIA, Door Bar Lower, 7.5in	N/A	1		HRP
PIA, Roof Bar Rear, 19in	N/A	1		HRP
Zip Tie (28")	73125312	15		MSC

Additional Parts

Part Description	Part Number	Qty	Torque Nm	Supplier
Pigtail - Fuel Injector (Port)	5U2Z-14S411-ZB	-		Ford Dealer
Pigtail - APP	9U2Z-14S411-BC	-		Ford Dealer
Pigtail - Throttle Position (TP)	AU2Z-14S411-MA	-		Ford Dealer
Pigtail - AAT	AU2Z-14S411-AGC	-		Ford Dealer
Pigtail - Variable Camshaft Timing (VCT) Solenoid	AU2Z-14S411-DB	-		Ford Dealer
Pigtail - Fuel Rail Pressure (Direct)	CU2Z-14S411-AVB	-		Ford Dealer
Pigtail - CPP Travel	CU2Z-14S411-AGB	-		Ford Dealer
Pigtail - PEM	DU2Z-14S411-CA	-		Ford Dealer
Pigtail - HP Fuel Pump	EU2Z-14S411-MB	-		Ford Dealer
Pigtail - CHT	GU2Z-14S411-KA	-		Ford Dealer
Pigtail - Cam Shaft Position	HU2Z-14S411-BA	-		Ford Dealer
Pigtail - Crankshaft Position	HU2Z-14S411-BA	-		Ford Dealer
Pigtail - Engine Oil Pressure (EOP)	HU2Z-14S411-BA	-		Ford Dealer
Pigtail - Intake Manifold Runner Controller (IMRC) Position	HU2Z-14S411-BA	-		Ford Dealer
Pigtail - Knock Sensor	JU2Z-14S411-TA	-		Ford Dealer
Pigtail - Fuel Rail Pressure/Temp (Port)*	JU2Z-14S411-CA	-		Ford Dealer
Pigtail - MAF/IAT	JU2Z-14S411-ACA	-		Ford Dealer
Pigtail - MAP	JU2Z-14S411-ACA	-		Ford Dealer
Pigtail - Ignition Coil	KU2Z-14S411-BA	-		Ford Dealer
Pigtail - Cooling Fan Relay Holder	LU2Z-14S411-GA	-		Ford Dealer
Pigtail - Fuel Injector (Direct) Harness BNK 1 - RH	MU5Z-14A411-LA	-		Ford Dealer
Pigtail - Fuel Injector (Direct) Harness BNK 2 - LH	MU5Z-14A411-MA	-		Ford Dealer
HP Fuel Pump - Tube Assembly	PR3Z-9J323-A	-		Ford Dealer
Axle Seal	AL3Z-4B416-A	-		Ford Dealer
Crankshaft Position Sensor	JR3Z-6C315-A	-		Ford Dealer
Ignition Coil A	JR3Z-12029-A	-		Ford Dealer
Ignition Coil B	JR3Z-12029-B	-		Ford Dealer
Spark Plug	CYFS-12Y-T6	-		Ford Dealer
Ignition Wire	JR3Z-12286-A	-		Ford Dealer
Throttle Body and Motor Assembly	JL3Z-9E926-A	-		Ford Dealer
Water Pump	BR3Z-8501-S	-		Ford Dealer
Water Heater Tube	PR3Z-18663-A	-		Ford Dealer

Change Log

Version #	Date	Summary of Changes
1	2.24.2025	-